

Technical Data Sheet

Compressor model **GP16TB**
 Voltage **220-240V 50Hz ~1**
 Refrigerant **R134a**

APPLICATION

Application High Back Pressure
 Refrigerant R134a
 Evaporating Temp. -15,0 °C to 10,0 °C
 Expansion Capillar/Valve
 Comp. Cooling Fan cooled
 Max. ambient temp. 43,0 °C
 Compatible refriger. R1234yf

COMPRESSOR

Displacement 16,15 cm³
 Diameter 31,19 mm
 Stroke 21,13 mm
 Net Weight 11,93 Kg
 Oil type ISO VG 32 ESTER
 Oil charge 400 cm³

MOTOR

Nominal Power 3/8 hp
 Voltage/Frequency 220-240V 50Hz
 Voltage range 198-255 V
 Type CSIR
 Phase number 1 PH
 Locked Rotor Amps (LRA) 20,00 A
 Max. Cont. Current (MCC) 5,00 A
 Main W. resist. at 25°C 4,83 Ω
 Start W. resist. at 25°C 20,22 Ω

NOMINAL PERFORMANCE

	ASHRAE	CECOMAF
Cooling Capacity	1.240 kCal/h	1.204 W
COP	2,09 W/W	1,80 W/W
EER	1,80 kCal/Wh	1,55 kCal/Wh
Input Power	690 W	670 W
Current	4,00 A	3,92 A

APPROVALS



TEST CYCLE CONDITIONS

	ASHRAE HBP (D)	CECOMAF HBP (C)
Evaporating temp. (T _e)	7,2 °C	5,0 °C
Condensing temp. (T _c)	55,0 °C	55,0 °C
Liquid temp. (T _{liq.})	46,0 °C	55,0 °C
Ambient temp. (T _{amb.})	35,0 °C	32,0 °C
Suction temp. (T _{suction})	35,0 °C	32,0 °C
Voltage/Frequency	220 V 50 Hz	220 V 50 Hz

ELECTRICAL COMPONENTS

Starting capacitor	72- 88 µF 330 V			
Relay	Option 1	Option 2		
Reference	2014 158.	QLZ-9.05A		
Pick-Up	9,05 A	9.05 A		
Drop-Out	7,70 A	7.7 A		
Protector	Option 1	Option 2		
Reference	MRA38133	T0267		
Current	11,50 A	11,00 A		
Time check	7,5-14 seg	7,5-14 seg		
Disc temp. (Open/Close)	105,00 / 52,00 °C	105,00 / 52,00 °C		

ASHRAE

Tc °C	Te °C	Cooling Capacity kCal/h	Consumption W	Current A	COP W/W	EER kCal/Wh
40	-15	560	400	3,01	1,63	1,40
40	-10	740	448	3,16	1,92	1,65
40	-5	945	495	3,30	2,22	1,91
40	0	1.175	539	3,45	2,53	2,18
40	5	1.430	582	3,60	2,86	2,46
40	7,2	1.550	600	3,66	3,00	2,58
40	10	1.710	622	3,75	3,19	2,75

45	-15	523	410	3,04	1,48	1,28
45	-10	688	463	3,20	1,73	1,49
45	-5	878	514	3,37	1,99	1,71
45	0	1.093	563	3,53	2,26	1,94
45	5	1.333	610	3,70	2,54	2,19
45	7,2	1.447	630	3,77	2,67	2,30
45	10	1.598	655	3,87	2,84	2,44

50	-15	487	420	3,07	1,35	1,16
50	-10	637	477	3,25	1,55	1,33
50	-5	812	533	3,43	1,77	1,52
50	0	1.012	586	3,62	2,01	1,73
50	5	1.237	638	3,80	2,25	1,94
50	7,2	1.343	660	3,89	2,37	2,04
50	10	1.486	687	3,99	2,51	2,16

55	-15	450	430	3,10	1,22	1,05
55	-10	585	492	3,29	1,38	1,19
55	-5	745	552	3,50	1,57	1,35
55	0	930	610	3,70	1,77	1,52
55	5	1.140	666	3,91	1,99	1,71
55	7,2	1.240	690	4,00	2,09	1,80
55	10	1.374	720	4,12	2,22	1,91

60	-15	413	440	3,13	1,09	0,94
60	-10	533	507	3,34	1,22	1,05
60	-5	678	571	3,56	1,38	1,19
60	0	848	634	3,79	1,56	1,34
60	5	1.043	694	4,02	1,75	1,50
60	7,2	1.137	720	4,12	1,84	1,58
60	10	1.263	753	4,25	1,95	1,68

65	-15	377	450	3,16	0,97	0,84
65	-10	482	521	3,39	1,08	0,92
65	-5	612	590	3,63	1,21	1,04
65	0	767	657	3,87	1,36	1,17
65	5	946	722	4,13	1,52	1,31
65	7,2	1.033	750	4,24	1,60	1,38
65	10	1.151	785	4,38	1,71	1,47

CECOMAF

Tc °C	Te °C	Cooling Capacity W	Consumption W	Current A	COP W/W	EER kCal/Wh
40	-15	603	402	3,02	1,50	1,30
40	-10	798	451	3,16	1,77	1,53
40	-5	1.019	498	3,31	2,05	1,77
40	0	1.266	543	3,46	2,33	2,02
40	5	1.540	586	3,61	2,63	2,27
40	7,2	1.668	604	3,68	2,76	2,39
40	10	1.839	627	3,76	2,94	2,54

45	-15	561	412	3,05	1,36	1,18
45	-10	738	466	3,21	1,59	1,37
45	-5	942	517	3,38	1,82	1,57
45	0	1.172	566	3,54	2,07	1,79
45	5	1.428	614	3,71	2,33	2,01
45	7,2	1.549	634	3,79	2,44	2,11
45	10	1.710	659	3,88	2,59	2,24

50	-15	518	422	3,08	1,23	1,06
50	-10	679	480	3,26	1,41	1,22
50	-5	865	536	3,44	1,61	1,39
50	0	1.077	590	3,63	1,83	1,58
50	5	1.316	642	3,82	2,05	1,77
50	7,2	1.429	664	3,90	2,15	1,86
50	10	1.581	692	4,01	2,28	1,97

55	-15	476	432	3,11	1,10	0,95
55	-10	619	495	3,30	1,25	1,08
55	-5	788	555	3,51	1,42	1,23
55	0	983	614	3,71	1,60	1,38
55	5	1.204	670	3,92	1,80	1,55
55	7,2	1.310	694	4,02	1,89	1,63
55	10	1.451	725	4,14	2,00	1,73

60	-15	434	442	3,14	0,98	0,85
60	-10	559	509	3,35	1,10	0,95
60	-5	711	574	3,57	1,24	1,07
60	0	888	637	3,80	1,39	1,20
60	5	1.092	698	4,03	1,56	1,35
60	7,2	1.190	725	4,14	1,64	1,42
60	10	1.322	757	4,27	1,75	1,51

65	-15	391	452	3,17	0,86	0,75
65	-10	499	524	3,40	0,95	0,82
65	-5	634	593	3,64	1,07	0,92
65	0	794	661	3,89	1,20	1,04
65	5	980	727	4,14	1,35	1,17
65	7,2	1.071	755	4,26	1,42	1,23
65	10	1.193	790	4,40	1,51	1,30

EN12900

X	Cooling Capacity (W)	Consumption (W)	Current (A)	Mass Flow (kg/h)
1	2.024,5025626687	362,2135251972	2,7822962813	35,043251978065
2	80,1202123638	1,6761773102	0,0008596805	1,4888457190122
3	-19,3796215808	4,8620584218	0,0179891829	-0,17888845387552
4	0,5162022127	-0,0346975284	0,0001120089	0,015772277844526
5	-0,7159814125	0,1869439274	0,0007828558	-0,0067118064402046

Equation	$x_1 + x_2Te + x_3Tc + x_4Te^2 + x_5TeTc$
----------	---

COMPRESSOR DIMENSIONS

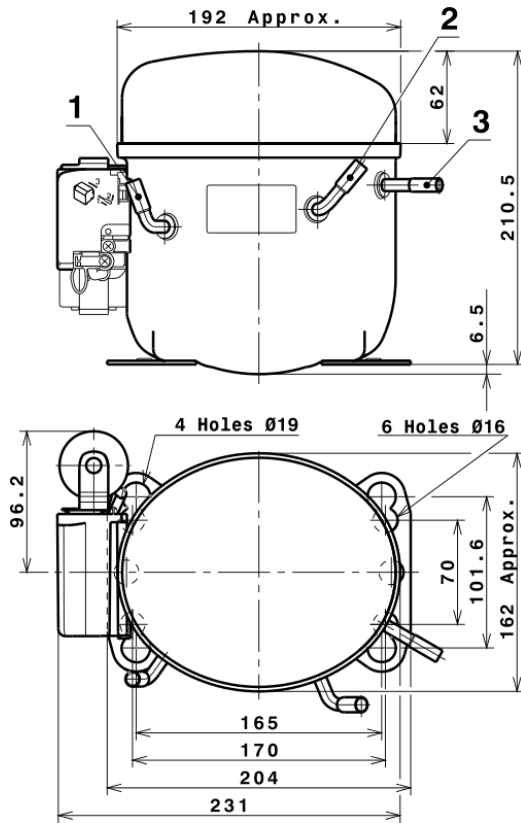

DESIGNATION INTERNAL DIAM.

1	Suction	8,1 mm
2	Service	8,1 mm
3	Discharge	6,5 mm

WIRING DIAGRAMS AND ELECTRICAL ASSEMBLY

CSIR CONNECTION (L, P ranges)



Technical Data Sheet

FIXINGS



SILENT BLOCKS (MOUNTING ACCESSORIES)

STANDARD

Ø16 holes (170x70 net)



AMERICAN FEET

Ø19 holes (165x101.6 net)



SNAP-ON

Ø16 holes (170x70 net)



SOA

SOA R134a HBP

