



D: 10 DIN Rail

E: 4 DIN Rail



D: 4 DIN Rail



## iProCHILL SERIES: up to 4 CIRCUIT and 16 COMPRESSOR UNIT CONTROLLERS

The controllers of iProCHILL family are the Dixell's answer to the requirements of the HVAC world; they are suitable for all **chillers, heat pump units up to 4 circuits and 16 compressors**. These instruments are complete and easy to use; they are the correct solution for the majority of the chiller-machines, including the most complex units, and can manage systems such as: **air/air, air/water, water/water, motor-condensing**.

Thanks to a **high degree of connectivity**, they are indispensable for remote management of a plant's "service" centers.

- Geothermal heat pump management with sanitary hot water production
- Instant and complete visualization of the unit values thanks to the VISOGRAPH graphic display and of the plant by means of the TGIPG touch display
- Powerful platform based on LINUX operative system on ARM9 microprocessor (200MHz/32bit)
- Ethernet for connection to an intranet-internet network
- USB output for configuration update
- Slave RS485 serial output for connection to XWEB supervising and controlling systems or to applications developed by third Party Systems
- BACnet communications allows the system to have easy and immediate integration with different manufactures ensuring complete interoperability
- Connection to the expansion modules in order to increase system capacity
- Connection to the drivers for electronic expansion valve management and control

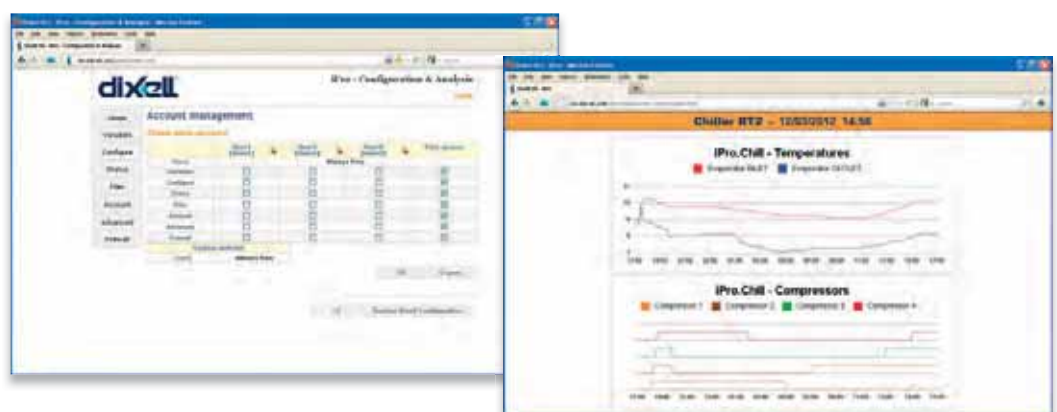

## KIND of COMPRESSORS

The extensive iProCHILL range allows optimal management of air conditioning units, equipped with different types of compressors of the largest manufacturers, via ModBUS, TCP/IP or through a dedicated analog signal.

- Multiscroll up to 16 compressors per circuit
- Scroll with Brushless permanent magnet motor
- Screw with regulation up to 4 capacity steps
- Stepless (only for 10 DIN format)
- Screw with inverter (also integrated)
- Reciprocating

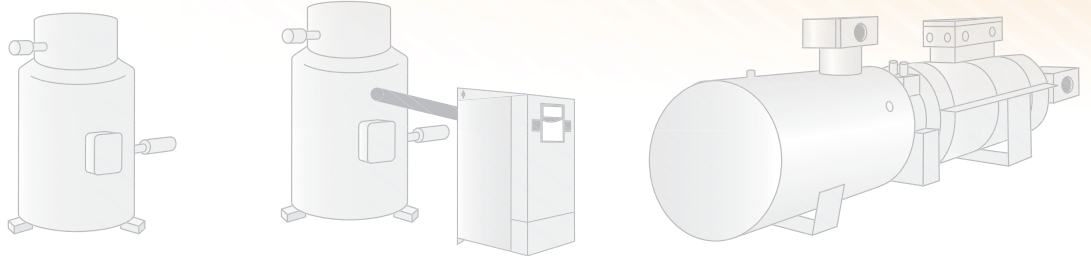

## CONNECTIVITY

The high degree of connectivity (Ethernet or RS485) of iProCHILL Dixell controllers enables local and remote management of units/plants. Some available functions are: machine status, alarms display, and commands that send modifications such as plant comfort settings and start/stop of unit/lights.

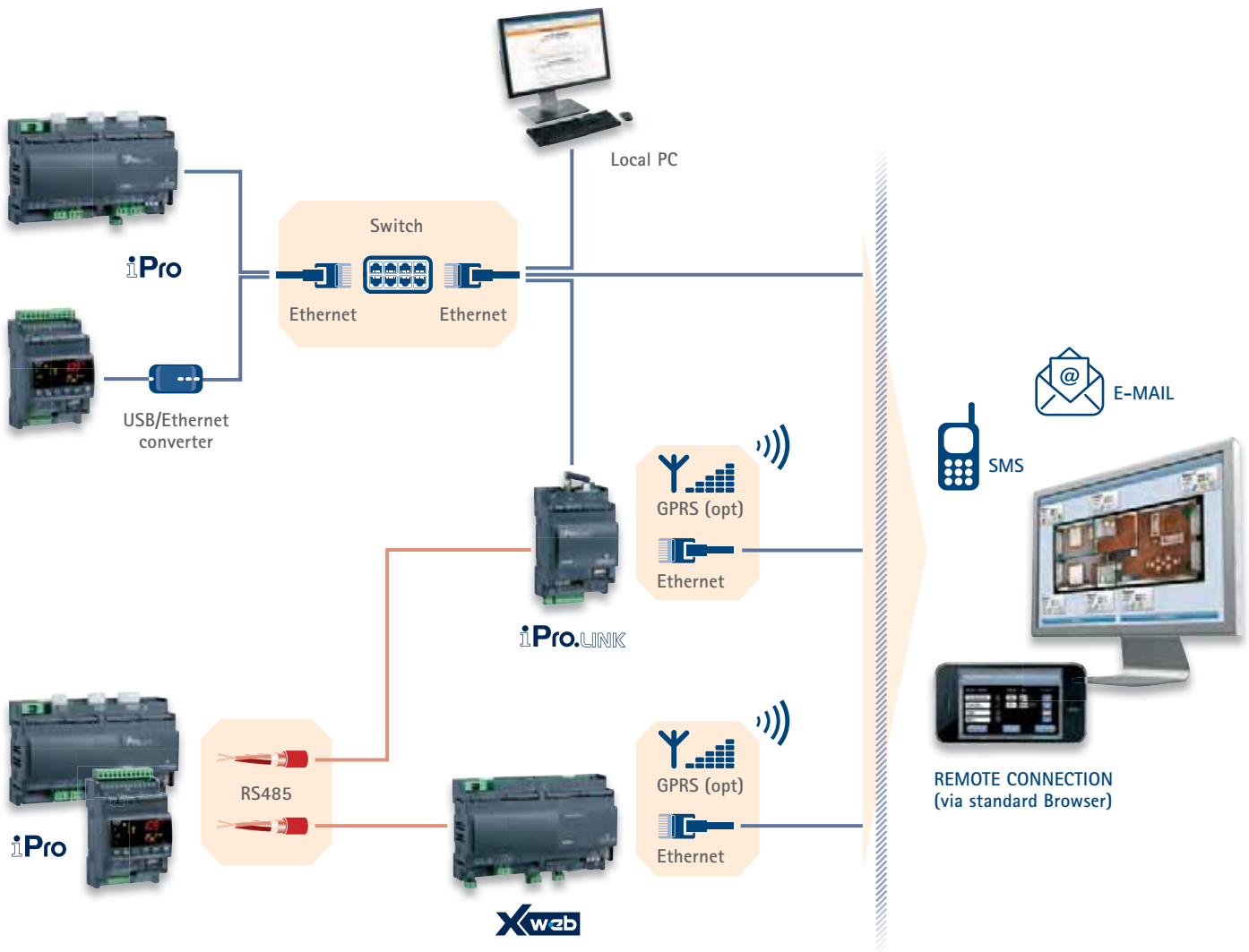



D, E: 4 DIN Rail

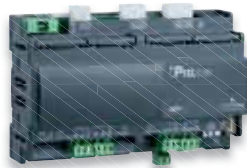

D: 10 DIN Rail

<b>IPC108D</b>	Controller in 4 DIN Rail format for up to 2 circuit and 6 compressor chiller and heat pumps
<b>IPC108E</b>	Controller in 4 DIN Rail format with LED display for up to 2 circuit and 6 compressor chiller and heat pumps
<b>IPC115D</b>	Controller in 10 DIN Rail format for up to 4 circuit and 16 compressors chiller and heat pumps

FEATURES	IPC108D	IPC108E	IPC115D
<b>First display: n° digits</b>		± 4 d.p.	
<b>Second display: n° digits</b>		± 4 d.p.	
<b>Power supply</b>	24Vac/dc from TF40D	24Vac/dc from TF40D	24Vac/dc from TF20D
<b>Probe inputs</b>			
0÷1V, 0÷5V, 0÷10V, 0÷20mA, 4÷20mA, NTC, PTC, DI	6 config	6 config	10 config
<b>Digital inputs</b>			
Optoinsulated	11 config	11 config	20 config
<b>Relay outputs</b>			
Configurable	8x5A	8x5A	12x5A + 3x8A 10x5A + 5xSSR opt
<b>Other outputs</b>			
PWM for fan speed module			2 config
0÷10V, 4÷20mA for fan speed module	4 config	4 config	
0÷10V for external relay			
RS485	slave	slave	4 master + slave
USB	pres	pres	pres
External modem			GSM, analogue opt
LAN/RS485 master	pres	pres	
CANBus			pres
Ethernet	via USB-ETH-CONV	via USB-ETH-CONV	opt
<b>Other</b>			
Remote keyboard	1xVGIPC	1xVGIPC	2xVGIPC
Internal modem			analogue opt
Real time clock	pres	pres	pres
Flash memory	32MB	32MB	128MB
Connections	disconnectable + screw	disconnectable + screw	disconnectable
Connection kit	DWS30-KIT, IP-FC108	DWS30-KIT, IP-FC108	DWB30-KIT
Expansion modules	IPX106D, IPX115D, IPX125D*	IPX106D, IPX115D, IPX125D*	IPX106D, IPX115D, IPX125D*
BACnet protocol	opt	opt	opt

\* References on page 40

### IPC108D - IPC108E

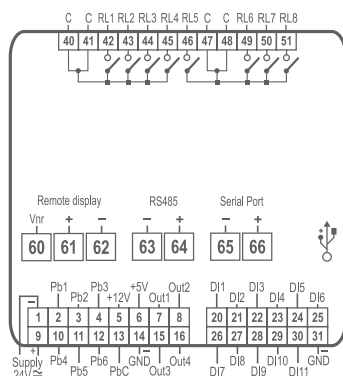

### IPC115D

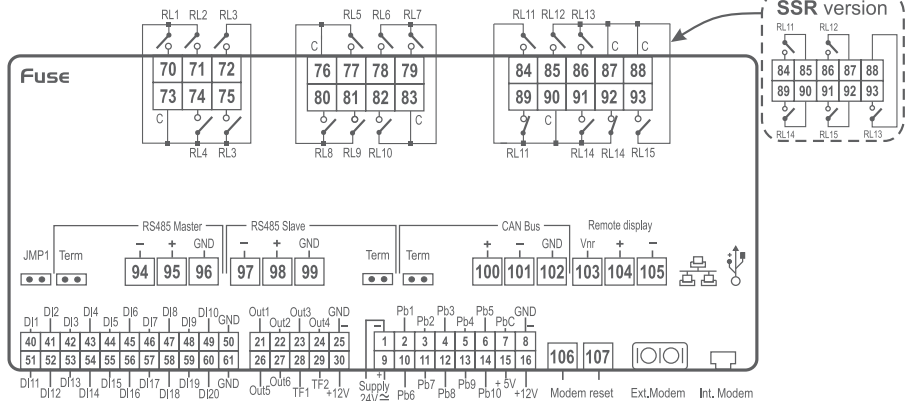

## TECHNICAL DATA

<b>Housing</b>	self extinguishing ABS
<b>Format</b>	4 DIN Rail: frontal 110x70mm; depth 59,5mm 10 DIN Rail: frontal 110x175mm; depth 59,5mm
<b>Display</b>	IPC108E: 4 digits red LED + 4 digits yellow LED + icons
<b>Mounting</b>	DIN Rail or wall mounting through integrated brackets
<b>Connections</b>	disconnectable connectors RS485 USB LAN (4 DIN Rail model) CANBus (10 DIN Rail model) Ethernet (10 DIN Rail model) Visograph
<b>Power supply</b>	24Vac/dc $\pm 10\%$ 50/60Hz
<b>Power absorption</b>	4 DIN Rail: 40VA max 10 DIN Rail: 20VA max
<b>Relay outputs</b>	4 DIN Rail: 8 SPDT 5(2)A, 250Vac 10 DIN Rail: 12 SPDT 5(2)A and 3 SPDT 8(3)A, 250Vac or 10 SPDT 5(2)A and 5 SSR, 250Vac
<b>Analog outputs</b>	PWM (fan module) 4 $\div$ 20mA (fan module) 0 $\div$ 10V (fan module or external relay)
<b>Data storing</b>	4 DIN Rail: on 16MB Flash memory 10 DIN Rail: on 128MB Flash memory
<b>RAM memory</b>	4 DIN Rail: 32MB 10 DIN Rail: 64MB
<b>Processor</b>	32bit
<b>CPU</b>	200MHz
<b>Operating temperature</b>	-10 $\div$ 60°C (14 $\div$ 140°F)
<b>Storage temperature</b>	-30 $\div$ 85°C (-22 $\div$ 185°F)
<b>Relative humidity</b>	20 $\div$ 85% (non condensing)
<b>Measuring and regulation range</b>	NTC probe: -50 $\div$ 110°C (-58 $\div$ 230°F) PTC probe: -50 $\div$ 150°C (-58 $\div$ 302°F)
<b>Resolution</b>	0,1°C or 1°F

## HOW to ORDER

IPC108D/E

I	P	C	1	0	8	-	1	0	C	D	0
---	---	---	---	---	---	---	---	---	---	---	---

C

D

### Ethernet, protocols

0 = No  
2 = BACnet

### Serial port

1 = LAN  
2 = RS485 master

IPC115D

I	P	C	1	1	5	D	-	A	B	C	0	E
---	---	---	---	---	---	---	---	---	---	---	---	---

A

B

C

E

### Power supply

1 = 24Vac/dc

UL versions  
2 = 24Vac

### Modem

0 = No  
1 = Internal modem (not for UL)  
2 = External modem  
3 = External + internal modem (not for UL)

### Ethernet, protocols

0 = No  
1 = Yes  
2 = BACnet

### N° relè SSR

0 = None  
2 = 5 SSR relays

## SPECIAL APPLICATIONS: QUICK GUIDE for PRODUCT CHOICE

Dixell's parametric and programmable controllers, besides a complete management of "traditional" chiller and heat pump units, are also the ideal solution for heat pumps with boiler or residential applications. The iProGENIUS family can be easily programmed to manage special applications such as Close control, Shelter, Roof-top, Air handling units (AHU) and Central air handling units.

### HEAT PUMPS with BOILER

For heat pumps with boiler, Dixell presents the **IC70CX**, a parametric, compact and flexible solution with special functions for hot water.

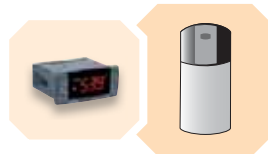

### RESIDENTIAL HEAT PUMPS

Parametric controller series (**IC200** and **IC200 evo** with related **TI**, **VI** and **VGI** keyboards) and programmable controllers (**iProCHILL**) promote comprehensive heat pump management and residential plant integration dedicated to geothermal, solar functions, and sanitary management.



### CLOSE CONTROL SHELTER – ROOF-TOP

Close control, Shelter and Roof-top units must be operated by versatile and powerful controllers. The **iProGENIUS** programmable controller line is the ideal solution for these needs because the user has a high-performance tool that allows you to easily create applications for every need.

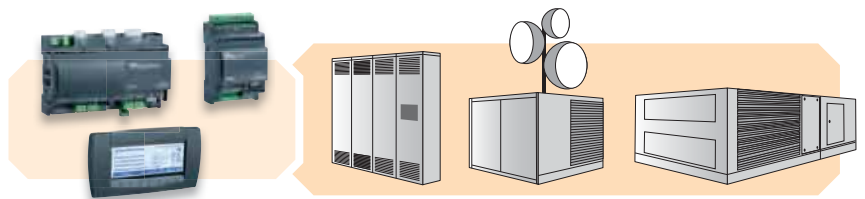

### AHU (air handling unit) – (central air handling unit)

Air Handling Units typically have several sections that have specific functions in the treatment of the air. The **iProGENIUS** controller is well suited to this modularity so because users can easily manage functions such as: mixing, air cooling and heating, dehumidification, and more.

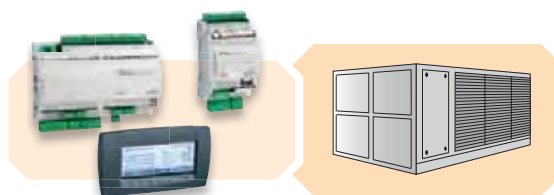



# GENERAL PURPOSE PROGRAMMABLE CONTROLLERS

## SECTION INDEX

FUNCTIONS	MODELS	
<b>iProGENIUS – general applications – high connectivity</b>		<b>36</b>
Development tool	iPro-TOOL	38
Programmable controllers with disconnectable connectors	IPG108D – IPG115D	39
Programmable controllers with bayonet connectors	IPG208D – IPG215D – IPG215F	39
Expansion modules with disconnectable connectors	IPX106D – IPX115D – IPX125D	40
Expansion modules with bayonet connectors	IPX206D – IPX215D – IPX225D	40
Connectivity module	IPL500D	41



## iProGENIUS SERIES: GENERAL PURPOSE PROGRAMMABLE CONTROLLERS with HIGH CONNECTIVITY

**iProGenius** is the Dixell family of programmable controllers that offers optimal solutions for all HVAC/R needs. They are suited for all applications in the PLC world including shopping centers, hospitals, airports, boatyards, energy management plants, and more. These controllers provide a high level of technology for ease of external connectivity and programmability providing simple answers for the user's needs, while offering local or remote monitoring control (accomplished with the powerful **iProLINK** connectivity module). An intuitive and useful HMI is also offered through the **VISOGRAPH** graphic display and the touch screen **TGIPG** display, while the expandability provided by the **IPX** modules allows use of these controllers with any machine, including the most complex.

- Powerful platform based on LINUX operative system on ARM9 (200MHz/32bit) microprocessor
- Internal Web Server with standard or customized Web Site
- Ethernet for connection to an intranet-internet network and to other controllers for a distributed application management
- USB output that allows the download of parameters, data/alarm logger and the applications and parameters upload
- Slave RS485 serial outputs for the connection to XWEB supervising and controlling systems or to applications developed by third Party Systems
- BACnet communications allows the system to have easy and immediate integration with different manufactures ensuring complete interoperability
- Connection to the expansion modules to increase system capacity
- Connection to the driver for the management and control of electronic expansion valves

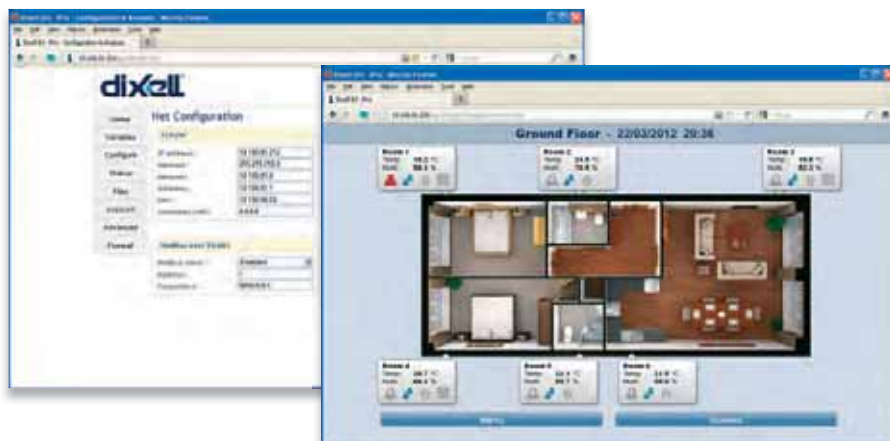

## CONNECTIVITY

The high degree of connectivity that marks iProGENIUS controllers, ensures a complete local and remote unit/plant management.

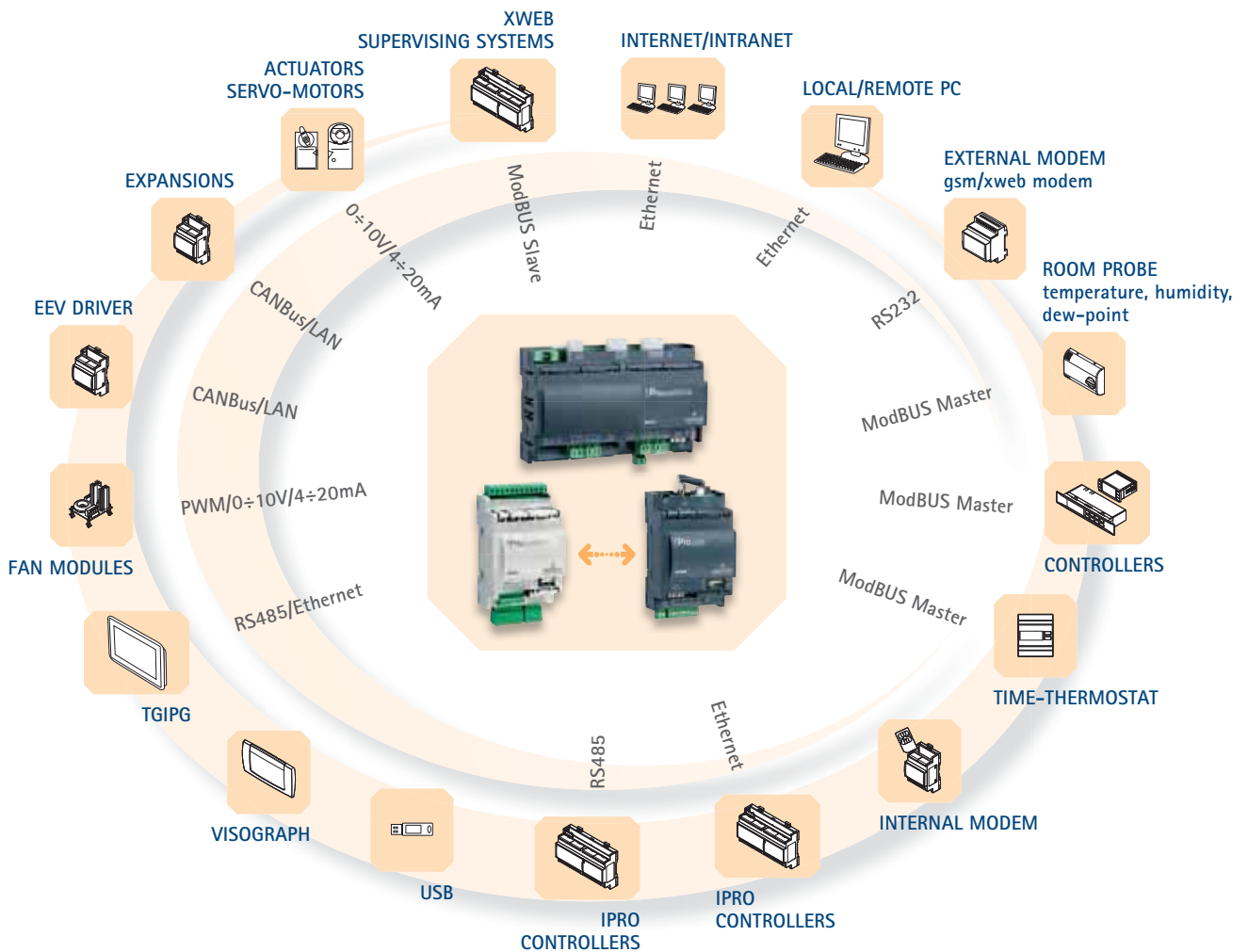
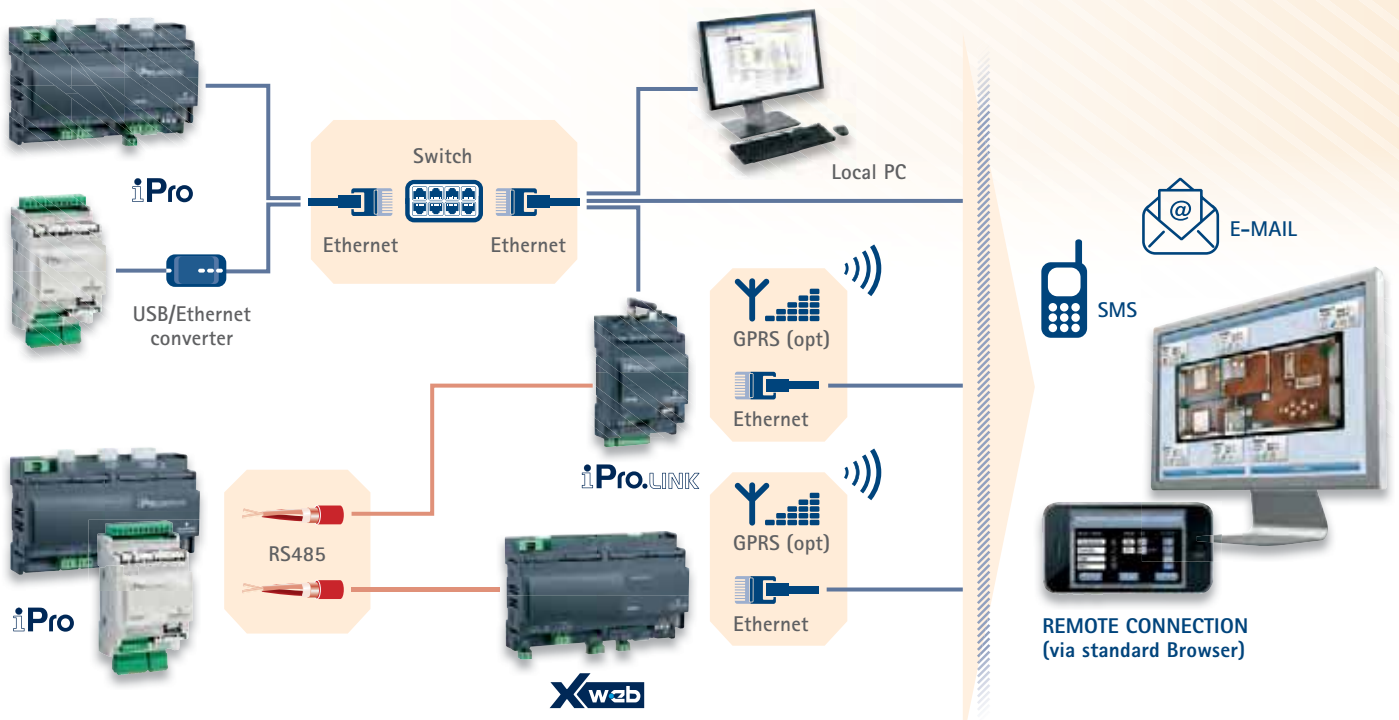



- 1 **ISaGRAF® + WIZMATE**
- 2 **ISaGRAF® + WIZMATE + VISOPROG**

**iPro-TOOL** is a complete and easy to use tool that allows the user to work independently to create programs for iPro controllers, taking advantage of all the programmable series potential. The package includes manuals and the **ISaGRAF®**, **WIZMATE** and **VISOPROG** (optional) software.

The user can choose among 2 options as you can see on the left.

Note: WIZMATE can be used with iProCHILL applications.

### ISaGRAF®

ISaGRAF® is the standard, international and complete development environment selected by Dixell to create programs that will be uploaded into the iPro series. Also ideal for small applications, it can manage several I/O points, allows users to create control systems, and is supported all over the world. ISaGRAF® offers a combination of a highly portable, robust management engines (Virtual Machine) and an intuitive application development environment (Workbench). ISaGRAF® integrates the best system for simulation and remote debugging, supports the Flow Chart (FC: Flow Chart) and 5 different programming languages coded according to IEC61131 (SFC: Sequential Function Chart; ST: Structured Text; FBD: Function Block Diagram; IL: Instruction List; LD: Ladder Diagram).

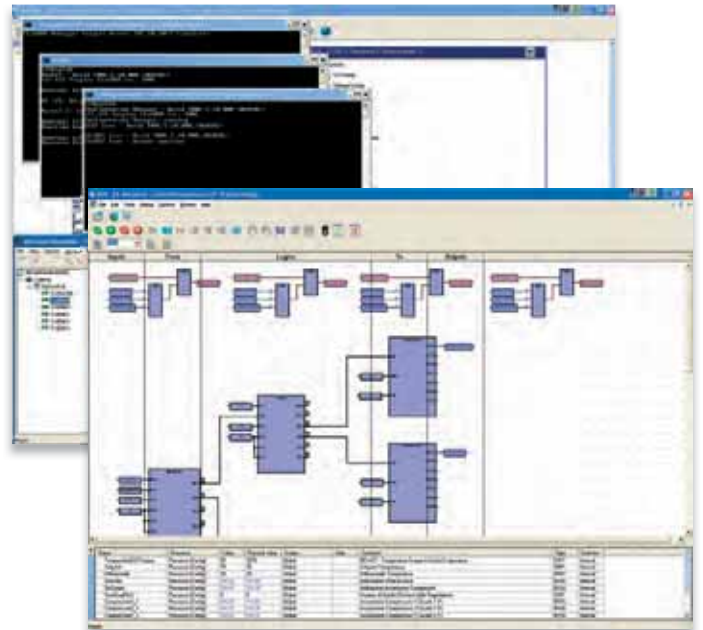

### WIZMATE

WIZMATE is versatile software that has a fast and easy programming mode for iPro controllers (ideal for versions with the application included like the iProCHILL).



### VISOPROG

The VISOPROG is a tool that allows users to create the VISOGRAPH keyboard graphic interfaces. The program, installed on a PC, is connected to ISaGRAF® project and has a basic interface that users can easily customize depending on the requirements.



# GENERAL PURPOSE PROGRAMMABLE CONTROLLERS

# iProGENIUS

<b>IPG108D</b>	Programmable controller in 4 DIN Rail format with disconnectable connectors
<b>IPG115D</b>	Programmable controller in 10 DIN Rail format with disconnectable connectors
<b>IPG208D</b>	Programmable controller in 4 DIN Rail format with bayonet connectors, ideal for the civil field
<b>IPG215D</b>	Programmable controller in 10 DIN Rail format with bayonet connectors, ideal for the civil field
<b>IPG215F</b>	Programmable controller in 10 DIN Rail format with front LED screen and bayonet connectors, ideal for civil engineering use



D: 4 DIN Rail



D, F: 10 DIN Rail

FEATURES	IPG108D	IPG115D	IPG208D	IPG215D-IPG215F
<b>Power supply</b>	24Vac/dc from TF40D	24Vac/dc from TF20D	24Vac/dc from TF40D	24Vac/dc from TF20D
<b>Probe inputs</b> 0÷1V, 0÷5V, 0÷10V, 0÷20mA, 4÷20mA, NTC, PTC, DI	6 config	10 config	6 config	10 config
<b>Digital inputs</b> Optoinsulated	11 config	20 config	11 config	20 config
<b>Relay outputs</b> Configurable	8x5A	12x5A + 3x8A	8x5A	12x5A + 3x8A
<b>Other outputs</b> PWM outputs for fan speed module 0÷10V or 4÷20mA outputs for fan speed module 0÷10V outputs for external relay RS485 USB External modem LAN/RS485 master CANBus Ethernet	4 config slave pres pres via USB-ETH-CONV	2 config 4 master + slave pres GSM, analogue opt pres opt	4 config slave pres pres via USB-ETH-CONV	2 config 4 master + slave pres GSM, analogue opt pres opt
<b>Other</b> Remote keyboard Internal modem Real time clock Flash memory Connections Connection kit Expansion modules BACnet protocol	1xVGIPG pres 32MB disconnectable DWS30-KIT, IP-FC108 IPX106D, IPX115D, IPX125D opt	2xVGIPG analogue opt pres 128MB disconnectable DWB30-KIT IPX106D, IPX115D, IPX125D opt	1xVGIPG pres 32MB bayonet IP-FC208 IPX206D, IPX215D, IPX225D opt	2xVGIPG analogue opt pres 128MB bayonet IP-FC215CP IPX206D, IPX215D, IPX225D opt

## IPG215F front

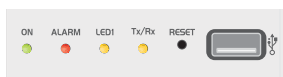

## IPG108D - IPG208D

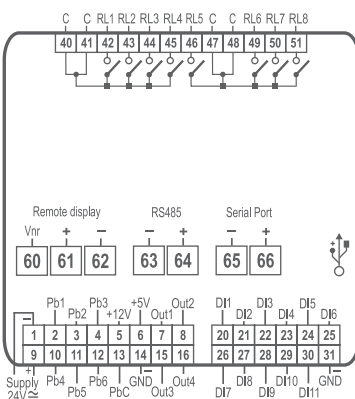

## IPG115D - IPG215D - IPG215F

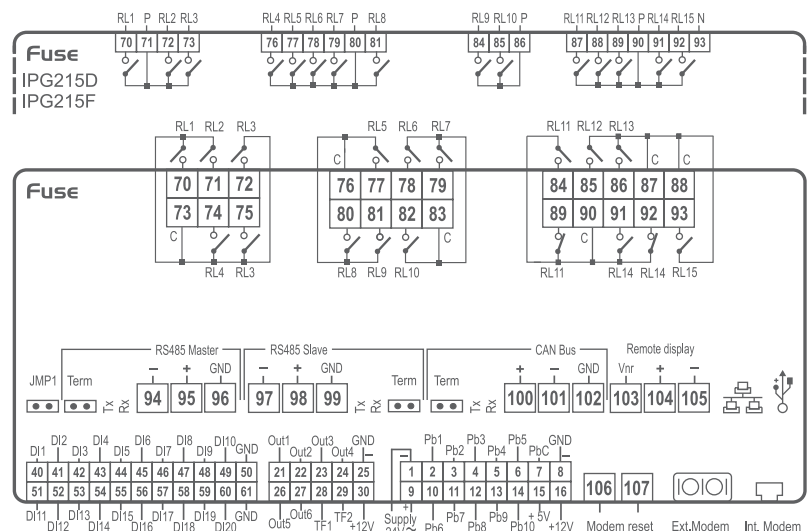



D: 4 DIN Rail

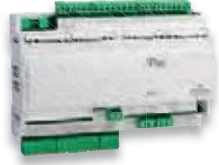

D: 10 DIN Rail

<b>IPX106D</b>	Expansion module in 4 DIN Rail format with disconnectable connectors and 6 relay outputs
<b>IPX115D</b>	Expansion module in 10 DIN Rail format with disconnectable connectors and 15 relay outputs
<b>IPX125D</b>	Expansion module in 10 DIN Rail format with disconnectable connectors and 25 relay outputs
<b>IPX206D</b>	Expansion module in 4 DIN Rail format with bayonet connectors and 6 relay outputs
<b>IPX215D</b>	Expansion module in 10 DIN Rail format with bayonet connectors and 25 relay outputs
<b>IPX225D</b>	Expansion module in 10 DIN Rail format with bayonet connectors and 25 relay outputs

FEATURES	IPX106D	IPX115D	IPX125D	IPX206D	IPX215D	IPX225D
<b>Power supply</b>	24Vac/dc from TF10D	24Vac/dc from TF20D	24Vac/dc from TF20D	24Vac/dc from TF10D	24Vac/dc from TF20D	24Vac/dc from TF20D
<b>Probe inputs</b> 0÷1V, 0÷5V, 0÷10V, 0÷20mA, 4÷20mA, NTC, PTC, DI	7 config	10 config	10 config	7 config	10 config	10 config
<b>Digital inputs</b> Optoisolated	3 config	20 config	20 config	3 config	20 config	20 config
<b>Relay outputs</b> Configurable	6x5A	12x5A + 3x8A	18x5A + 3x8A + 4xSSR	6x5A	15x5A	21x5A + 4xSSR
<b>Other outputs</b> 0÷10V, 4÷20mA 0÷10V LAN CANBus	3 pres pres	2 config 4 pres	2 config 4 pres	3 pres pres	2 config 4 pres	2 config 4 pres
<b>Other</b> Dip switch for address set Connections Connection kit	pres disconnectable DWEX60-30KIT	pres disconnectable DWX115-30KIT	pres disconnectable DWEX70-30KIT	pres bayonet IP-FCEX60	pres bayonet IP-FCEX215	pres bayonet IP-FCEX70

### IPX106D - IPX206D

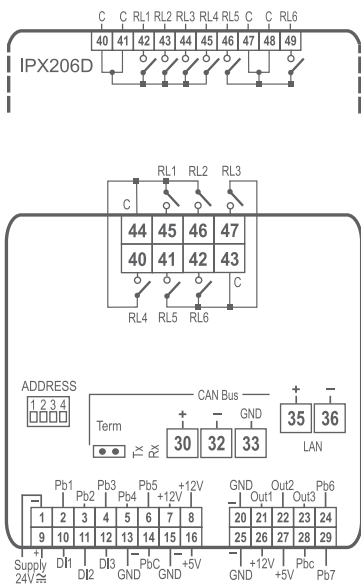

### IPX115D - IPX125D - IPX215D - IPX225D

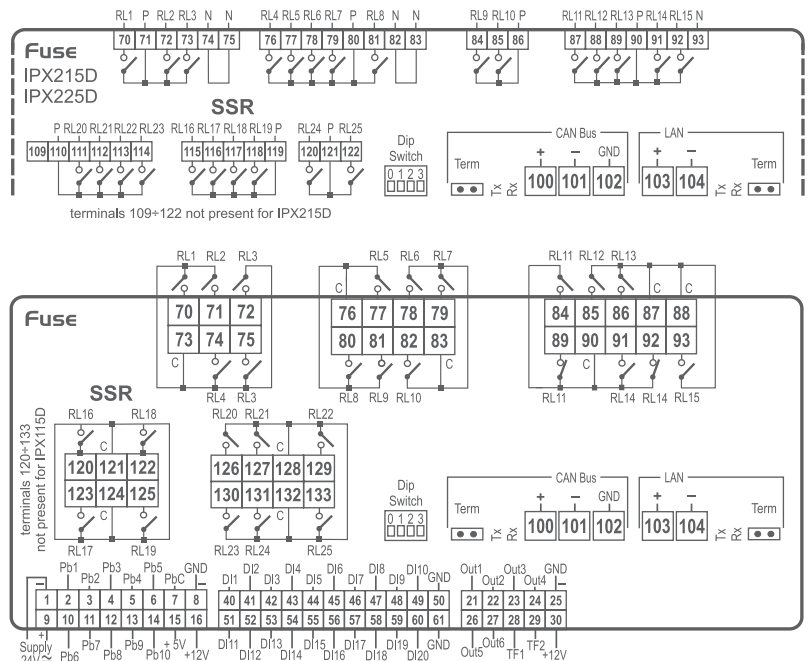

## IPL500D

Programmable connectivity module designed to collect, store, process and manage data. It is compatible with the iPRO controllers and allows downloading of applications for data processing or management of other integrated devices



D: 4 DIN Rail

FEATURES	IPL500D
<b>Power supply</b>	24Vac/dc from TF20D
<b>Outputs</b>	
RS485	slave
USB	pres
LAN/RS485 master	pres
CANBus	pres
Ethernet	pres
<b>Other</b>	
Remote keyboard	VGIPG
Internal modem	GPRS opt
Real time clock	pres
Flash memory	128MB
Connections	screw
Connection kit	IP-FC500
BACnet protocol	opt

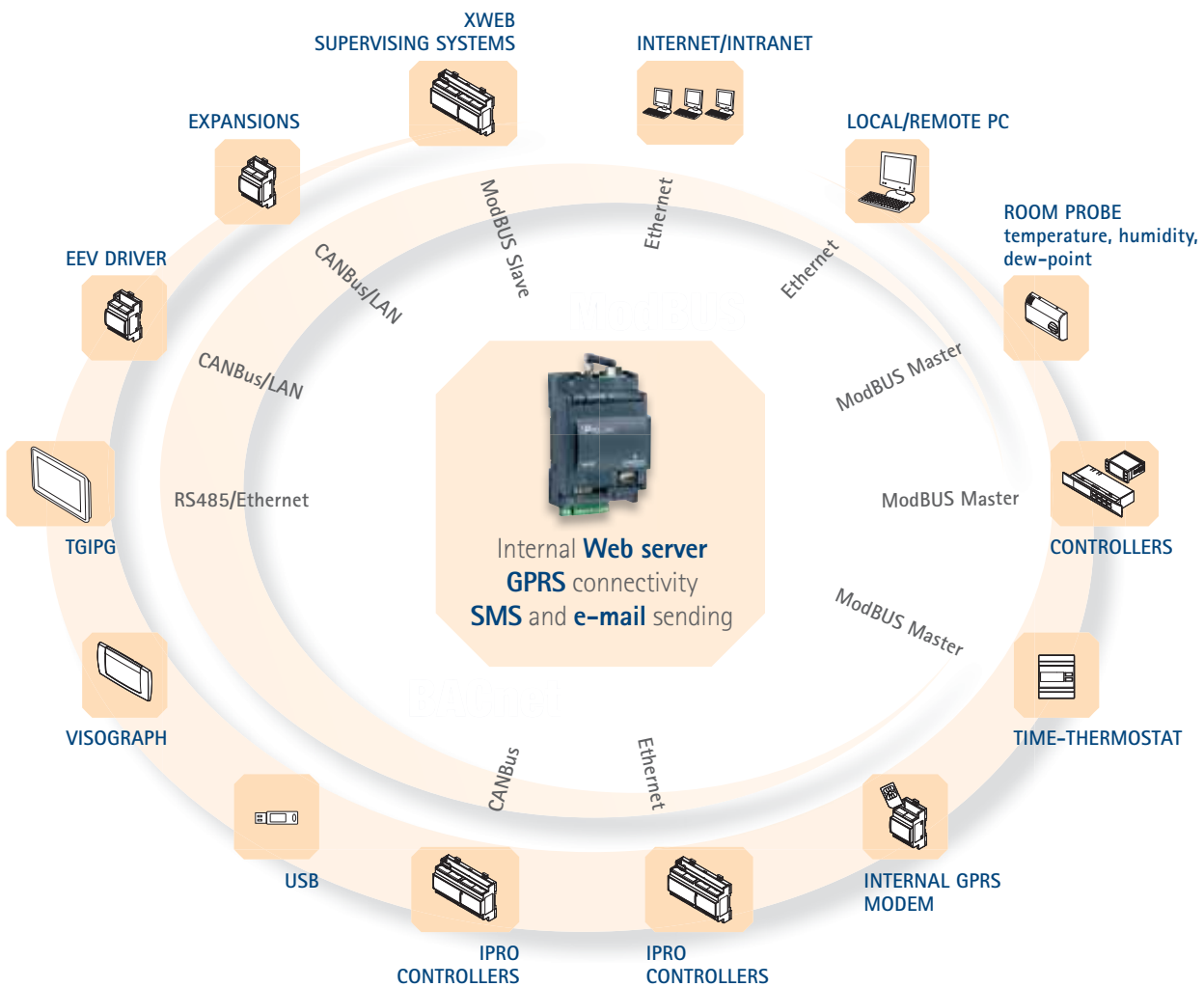
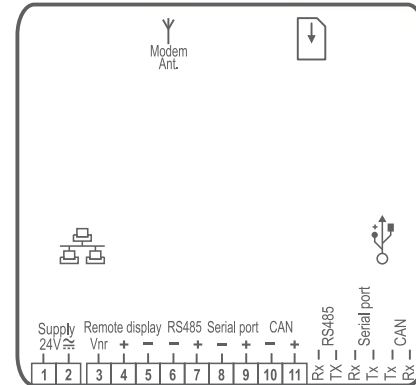

## TECHNICAL DATA

<b>Housing</b>	self extinguishing ABS
<b>Format</b>	4 DIN Rail: frontal 110x70mm; depth 59,5mm 10 DIN Rail: frontal 110x175mm; depth 59,5mm
<b>Mounting</b>	DIN Rail or wall mounting through integrated brackets
<b>Connections</b>	disconnectable, bayonet and screw connectors (depending on the model) RS485, USB, LAN, CANBus, Ethernet, Visograph (depending on the model)
<b>Power supply</b>	24Vac/dc ±10% 50/60Hz
<b>Power absorption</b>	IPG (4 DIN Rail): 40VA max IPG (10 DIN Rail), IPX (10 DIN Rail), IPL500D: 20VA max IPX (4 DIN Rail): 10VA max
<b>Relay outputs</b>	IPG (4 DIN Rail): 8 SPDT 5(2)A, 250Vac IPG (10 DIN Rail): 12 SPDT 5(2)A and 3 SPDT 8(3)A, 250Vac IPX (4 DIN Rail): 6 SPDT 5(2)A, 250Vac IPX115D: 12 SPDT 5(2)A and 3 SPDT 8(3)A, 250Vac IPX125D: 18 SPDT 5(2)A, 3 SPDT 8(3)A and 4 SSR, 250Vac IPX215D: 15 SPDT 5(2)A, 250Vac IPX225D: 21 SPDT 5(2)A and 4 SSR, 250Vac
<b>Analog outputs</b>	PWM, 4÷20mA, 0÷10V (depending on the model)
<b>Data storing</b>	IPG (4 DIN Rail): on 32MB Flash memory IPG (10 DIN Rail), IPL500D: on 128MB Flash memory
<b>RAM memory</b>	IPG (4 DIN Rail) 32MB IPG (10 Din Rail) 64MB
<b>Processor</b>	32bit
<b>CPU</b>	200MHz
<b>Operating temperature</b>	-10÷60°C (14÷140°F)
<b>Storage temperature</b>	-30÷85°C (-22÷185°F)
<b>Relative humidity</b>	20÷85% (non condensing)
<b>Measuring and regulation range</b>	NTC probe: -50÷110°C (-58÷230°F) PTC probe: -50÷150°C (-58÷302°F)
<b>Resolution</b>	0,1°C or 1°F

## HOW to ORDER

IPG108D – IPG208D	I P G 0 8 D - 1 0 C D 0
IPG115D – IPG215D/F	I P G 1 5 - A B C 0 0
IPX106D – IPG206D	I P X 0 6 D - 1 0 0 0 0
IPX115D – IPX215D	I P X 1 5 D - 1 0 0 0 0
IPX125D – IPX225D	I P X 2 5 D - 1 0 0 0 2

A	B	C	D
<b>Power supply</b>	<b>Modem</b>	<b>Ethernet, protocols</b>	<b>Serial port</b>
1 = 24Vac/dc <b>UL versions</b> 2 = 24Vac 3 = 24Vdc (for IPG215)	0 = No 1 = Internal modem (not for UL) 2 = External modem 3 = External + internal modem (not for UL)	0 = No 1 = Yes (for IPG115D, IPG215D and IPG215F) 2 = BACnet	1 = LAN 2 = RS485 master

IPL500D	I P L 5 0 0 D - 1 B C D 0
---------	---------------------------

B	C	D
<b>Modem</b>	<b>Ethernet, protocols</b>	<b>Serial port</b>
0 = No 1 = Internal modem GPRS	1 = Yes 2 = BACnet	1 = LAN 2 = RS485 master

IPRO-TOOL	I P R O - T O O L - 0 0 0 0 0
-----------	-------------------------------

IPRO-TOOL + 2 Visoprog licences	I P R O - T O O L - 0 0 0 0 0 1
---------------------------------	---------------------------------