



iPro.CHIL

IPC108D – IPC108E (v.2.5)

APPLICATION GUIDE

INDEX

1.	IMPORTANT RECOMMENDATIONS	6
1.1	PRODUCT DISPOSAL (WEEE)	7
2.	GENERALITIES	8
3.	AVAILABLE APPLICATION CONFIGURATIONS	8
3.1	MAIN FUNCTIONS	9
4.	SUPERVISION FROM LOCAL AND REMOTE	12
5.	USER INTERFACE VISOGRAPH 1.0 AND VISOGRAPH 2.0	13
5.1	HOW TO SWITCH ON/OFF THE UNIT AND CHANGE CHILLER/HEAT PUMP WORK MODE FROM KEYBOARD	15
5.1.1	Unit Switch-ON/OFF From The Keyboard	16
5.1.2	Unit Switch-ON/OFF From Digital Input.....	18
5.1.3	Select The Working Mode: Chiller-Heat Pump	18
5.1.4	Change Over Function.....	19
5.2	UNIT SWITCH ON/OFF BY RTC	20
5.2.1	Working With Clock Disabling Digital Input.....	20
5.2.2	Working With “Ventilation Only” Digital Input (Air-Air Unit Only)	22
5.2.3	Working With Unit In OFF From RTC If ON Is Forced From Key	22
5.3	OPERATION IN CONDENSING UNIT WORKING MODE	23
5.3.1	Working With Digital Input Configuration As Temperature Control Request.....	23
5.3.2	Working With Digital Input Configured As Cooling Request.....	23
5.3.3	Working With Digital Input Configured As Heating Request.....	23
5.4	HOW TO MODIFY THE INFORMATION PRESENT IN THE MAIN SCREEN	24
5.4.1	Select Probes For Display	24
5.5	SET KEY IN MAIN SCREEN	24
5.6	PROBES KEY IN MAIN SCREEN	26
5.7	ALARM KEY IN MAIN SCREEN	27
5.8	CIRC KEY IN MAIN SCREEN	29
5.9	SERVICE KEY IN MAIN SCREEN	34
5.9.1	Parameters Programming.....	35
5.9.2	Time/Time Bands	37
5.9.3	Compressors.....	38
5.9.4	Water Pump	40
5.9.5	Alarms Display	41
5.9.6	Historical Alarms	41
5.9.7	Defrost.....	43
5.9.8	Heaters/Liquid Line Solenoid Valve	44
5.9.9	I/O Status	45
5.9.10	Thermostatic	47
5.9.11	Heat Recovery	48
5.9.12	Auxiliary Outputs	49
5.9.13	Free-Cooling	50
5.9.14	Screw Compressor	53
5.9.15	Discharge Compressor Temperature	54
5.9.16	Domestic Hot Water (Sanitary Water)	55
5.9.17	Auxiliary Heating	57
5.9.18	Control Panel	57
6.	USER INTERFACE VISOTOUCH	62

6.1	HOW TO SWITCH ON/OFF THE UNIT AND CHANGE CHILLER/HEAT PUMP WORK MODE FROM VISOTOUCH	64
6.1.1	Unit Switch-ON/OFF From The Visotouch.....	65
6.1.2	Unit Switch-ON/OFF From Digital Input.....	67
6.1.3	Select The Working Mode: Chiller-Heat Pump.....	67
6.1.4	Change Over Function.....	68
6.2	UNIT SWITH ON/OFF BY RTC	68
6.2.1	Working With Clock Disabling Digital Input.....	68
6.2.2	Working With “Ventilation Only” Digital Input (Air-Air Unit Only).....	70
6.2.3	Working With Unit In OFF From RTC If ON Is Forced From Visotouch.....	70
6.3	OPERATION IN CONDENSING UNIT WORKING MODE	71
6.3.1	Working With Digital Input Configuration As Temperature Control Request.....	71
6.3.2	Working With Digital Input Configured As Cooling Request.....	71
6.3.3	Working With Digital Input Configured As Heating Request.....	71
6.4	HOW TO MODIFY THE INFORMATION PRESENT IN THE MAIN SCREEN	72
6.4.1	Select Probes For Display.....	72
6.5	INFORMATION BUTTON IN MAIN SCREEN	72
6.6	ALARM BUTTON IN MAIN SCREEN	73
6.7	FREE BUTTON IN MAIN SCREEN	75
6.7.1	Probes Submenu.....	75
6.7.2	Setpoint Submenu.....	76
6.7.3	Circuits Submenu.....	78
6.7.4	Icons Submenu.....	78
6.8	SERVICE MENU	83
6.8.1	Parameters Programming.....	85
6.8.2	Time/Time Bands.....	87
6.8.3	Compressors.....	88
6.8.4	Water Pump.....	89
6.8.5	Alarms Display.....	90
6.8.6	Historical Alarms.....	90
6.8.7	Defrost.....	92
6.8.8	Heaters/Liquid Line Solenoid Valve.....	94
6.8.9	I/O Status.....	94
6.8.10	Thermostatic.....	96
6.8.11	Heat Recovery.....	97
6.8.12	Auxiliary Outputs.....	98
6.8.13	Free-Cooling.....	99
6.8.14	Screw Compressor.....	102
6.8.15	Discharge Compressor Temperature.....	103
6.8.16	Domestic Hot Water (Sanitary Water).....	103
6.8.17	Auxiliary Heating.....	105
6.8.18	Control Panel.....	106

7. LED INTERFACE 109

7.1	THE DEFAULT SCREEN	110
7.2	HOW TO CHANGE SET POINT	112
7.3	HOW TO ADJUST CLOCK	113
7.4	HOW TO PROGRAM PARAMETERS	114
7.5	MAIN MENU SCREEN	115
7.5.1	Active Alarms Sub-Menu.....	116
7.5.2	Historical Alarms Sub-Menu.....	117
7.5.3	Compressor Enable/Disable Sub-Menu.....	118
7.5.4	Compressor Starts Number Sub-Menu.....	119
7.5.5	Compressor/Water Pump Working Hours Sub-Menu.....	119
7.5.6	Water Pump Enable/Disable Sub-Menu.....	120
7.5.7	Condensation Fan Sub-Menu.....	120
7.5.8	Defrost Sub-Menu.....	121
7.5.9	I/O Status Sub-Menu.....	121
7.5.10	Electronic Thermostatic Valves Sub-Menu.....	123
7.5.11	Free-Cooling Sub-Menu.....	123
7.5.12	Configuration File Management Sub-Menu.....	124

7.5.13	USB Management Sub-Menu	125
7.5.14	System Information Sub-Menu	126

8. USE WIZMATE TO CONFIGURE PARAMETERS 127

8.1	HOW TO INSTALL WIZMATE	127
8.2	LOGIN WIZMATE	130
8.3	WIZMATE CONFIGURATION	133
8.3.1	Configuration Menu	133
8.3.2	Language Configuration	133
8.3.3	Import/Export Maps And Libraries	133
8.4	HOW TO USE WIZMATE	137
8.4.1	Scan For Device	137
8.4.2	Read Parameters Value	137
8.4.3	Change Parameters Value	139
8.4.4	Save/Open Map	139

9. PARAMETERS IN TABLE FORM 141

10. ANALOGUE - DIGITAL INPUTS/OUTPUTS CONFIGURATIONS 172



10.1	DI1 – DI11 DIGITAL INPUTS CONFIGURATION (DI TYPE)	172
10.2	RL1- RL15 DIGITAL OUTPUTS CONFIGURATION (DO TYPE)	174
10.3	ANALOGUE INPUTS PB1 - PB10 CONFIGURATION (AI TYPE)	175
10.4	CONFIGURATION OF THE OUT1 / OUT4 PROPORTIONAL OUTPUTS (AO TYPE)	176
10.5	ANALOGUE INPUTS CALIBRATION	176
10.6	ANALOGUE INPUTS RANGE	177
10.7	FURTHER CONNECTIONS	177

11. ALARMS 178

11.1	PROBE BREAKDOWN	178
11.2	HIGH PRESSURE PRESSURE SWITCH ALARM	178
11.3	COMPRESSOR HIGH DISCHARGE THERMOSTAT ALARM FROM DIGITAL INPUT	179
11.4	LOW PRESSURE PRESSURE SWITCH ALARM	180
11.5	OIL FLOAT/PRESSURE SWITCH ALARM	181
11.6	CONDENSATION HIGH TEMPERATURE/ PRESSURE ALARM	182
11.7	LOW CONDENSATION TEMPERATURE/PRESSURE ALARM (IF THE EVAPORATOR PRESSURE PROBES ARE NOT CONFIGURED)	183
11.8	LOW EVAPORATION PRESSURE ALARM (IF THE EVAPORATOR PRESSURE PROBES ARE CONFIGURED)	184
11.9	AIR/AIR UNIT LOW TEMPERATURE ALARM & ANTI-FREEZE ALARM IN CHILLER MODE	185
11.10	AIR/AIR UNIT LOW TEMPERATURE ALARM & ANTI-FREEZE ALARM IN HEAT PUMP MODE	186
11.11	AIR/AIR UNIT LOW TEMPERATURE ALARM & ANTI-FREEZE ALARM	187
11.12	EVAPORATOR SIDE FLOW SWITCH ALARM (DIFFERENTIAL PRESSURE SWITCH)	188
11.13	HOT SIDE FLOW SWITCH ALARM (DIFFERENTIAL PRESSURE SWITCH)	190
11.14	SUPPLY FAN OVERLOAD ALARM	191
11.15	DOMESTIC HOT WATER PUMP FLOW SWITCH ALARM	191
11.16	SOLAR PANELS WATER PUMP FLOW SWITCH ALARM	192
11.17	COMPRESSOR OVERLOAD ALARM	192
11.18	COMPRESSOR HIGH DISCHARGE TEMPERATURE ALARM FROM ANALOGUE INPUT	193
11.19	EVAPORATOR WATER INLET HIGH TEMPERATURE ALARM	193
11.20	CONDENSATION FAN OVERLOAD ALARM	194
11.21	DEFROST ALARM	194
11.22	UNLOADING ALARM DUE TO HIGH CONDENSATION TEMPERATURE/PRESSURE IN COOLING WORKING MODE	195
11.23	HEAT RECOVERY DISABLING SIGNAL DUE TO HIGH CONDENSATION TEMPERATURE/PRESSURE IN COOLING WORKING MODE	195
11.24	UNLOADING SIGNAL DUE TO LOW EVAPORATION PRESSURE IN HEATING WORKING MODE	196
11.25	UNLOADING SIGNAL DUE TO EVAPORATOR WATER INLET HIGH TEMPERATURE	197

11.26	PUMP DOWN ALARM WITH LOW PRESSURE PRESSURE SWITCH/TRANSDUCER IN STOPPING	197
11.27	PUMP DOWN ALARM WITH LOW PRESSURE TRANSDUCER IN START-UP	198
11.28	EVAPORATOR WATER PUMP OVERLOAD ALARM	198
11.29	CONDENSER WATER PUMPING OVERLOAD ALARM	199
11.30	GENERIC ALARM 1	200
11.31	GENERIC ALARM 2	200
11.32	COMPRESSORS MAINTENANCE ALARM	200
11.33	EVAPORATOR FAN/ PUMPS MAINTENANCE ALARM	200
11.34	CONDENSER PUMPS MAINTENANCE ALARM	201
11.35	XEV20D NOT CONNECT ALARM	201
11.36	EXPANSION MOUDLE NOT CONNECT ALARM	201
11.37	PHASES SEQUENCE ALARM	202
11.38	ANTI-FREEZE ALARM IN FREE-COOLING	202
11.39	BOILER OVERLOAD ALARM	202
11.40	BOILER LOCK ALARM	203
11.41	UNIT CONFIGURATION	204
11.42	FUNCTION NOT AVAILABLE ALARM	208
11.43	NOTE: ALARM RELAY AND BUZZER	209
12.	NO VOLTAGE	209
13.	AUTOMATIC TO MANUAL RESET ALARMS DIAGNOSTICS	209
14.	OUTPUTS BLOCK TABLE	210
14.1	CIRCUIT "A" OUTPUTS ALARM BLOCK TABLE	210
14.2	CIRCUIT "B" OUTPUTS ALARM BLOCK TABLE	212
14.3	COMPRESSOR "C" ALARMS OUTPUTS BLOCK TABLE	212

1. IMPORTANT RECOMMENDATIONS

- The  symbol alerts the user of non-insulated “dangerous voltage” within the product area that is sufficiently high to constitute a risk of electric shock to persons.
- The  symbol alerts the user of important operating and maintenance (assistance) instructions found in the documentation attached to the device.
- Dixell Srl cannot accept any liability for damages caused by modems that are not supported. Dixell Srl reserves the right to modify this manual without prior notice. The documentation can be downloaded from www.dixell.com even prior to purchase.
- This manual forms part of the product and must always be kept near the device for easy and quick reference. The device cannot be used as a safety device. Verify the limits of application before using the device.
- Verify that the power supply voltage is correct before connecting the device. Do not expose it to water or humidity: use the controller only within the operating limits, avoiding sudden changes in temperature and high atmospheric humidity in order to prevent condensation from forming. Recommendation: disconnect all the electric connections before performing any maintenance. Insert the probe where it cannot be reached by the End User. The device must not be opened. Consider the maximum current that can be applied to each relay. Make sure that the wires for the probes, the loads and the electrical power supply are separated and sufficiently distant from each other, without crossing or intertwining with each other. In the case of applications in industrial environments, it may be useful to use the main filters (our mod. FT1) in parallel to the inductive loads.
- The customer shall bear full responsibility and risk for product configuration in order to achieve the results pertaining to installation and/or final equipment/system. Upon the customer's request and following a specific agreement, Dixell s.r.l. may be present during the start-up of the final machine/application, as a consultant, however, under no circumstances can the company be held responsible for the correct operation of the final equipment/system.
- Since Dixell products form part of a very high level of technology, a qualification/configuration/programming/commissioning stage is required to use them as best as possible. Otherwise, these products may malfunction and Dixell cannot be held responsible. The product must not be used in any way that differs from that stipulated in the documentation.
- The device must always be inserted inside an electrical panel that can only be accessed by authorised personnel. For safety purposes, the keyboard must be the only part that can be reached.
- The device must never be hand-held while being used.

- It is good practice to bear the following in mind for all Dixell products:
 - Prevent the electronic circuits from getting wet as contact made with water, humidity or any other type of liquid can damage them. Comply with the temperature and humidity limits specified in the manual in order to store the product correctly.
 - The device must not be installed in particularly hot environments as high temperatures can damage it (electronic circuits and/or plastic components forming part of the casing). Comply with the temperature and humidity limits specified in the manual in order to store the product correctly.
 - Under no circumstances is the device to be opened - the user does not require the internal components. Please contact qualified service personnel for any assistance.
 - Prevent the device from being dropped, knocked or shaken as either can cause irreparable damage.
 - Do not clean the device with corrosive chemical products, solvents or aggressive detergents.
 - The device must not be used in applications that differ from that specified in the following material.



- ***Separate the power of the device from the rest of the electrical devices connected inside the electrical panel. The secondary of the transformer must never be connected to the earth.***
- Dixell Srl reserves the right to change the composition of its products, even without notice, ensuring the same and unchanged functionality."

1.1 PRODUCT DISPOSAL (WEEE)

With reference to Directive 2002/96/EC of the European Parliament and of the Council of 27 January 2003 and to the relative national legislation, please note that:

- There lies the obligation not to dispose of electrical and electronic waste as municipal waste but to separate the waste.
- Public or private collection points must be used to dispose of the goods in accordance with local laws. Furthermore, at the end of the product's life, it is also possible to return this to the retailer when a new purchase is made.
- This equipment may contain hazardous substances. Improper use or incorrect disposal can have adverse effects on human health and the environment.
- The symbol shown on the product or the package indicates that the product has been placed on the market after 13 August 2005 and must be disposed of as separated waste.
- Should the product be disposed of incorrectly, sanctions may be applied as stipulated in applicable local regulations regarding waste disposal.

2. GENERALITIES

iProCHILL is a programmable controller for application on Air Conditioning units up to 2 circuits and 3 compressors per circuit.

It is possible to manage the following units:

- Air/air (for very simple unit)
- Air/water
- Water/water
- Condensing Units

All types with:

- Heating with gas reversibility
- Free cooling function
- Recovery function
- Domestic hot water function

3. AVAILABLE APPLICATION CONFIGURATIONS

The controller can manage various of equipments and functions, find the table below for possible combinations:

Application		Chiller water/water	Chiller air/water	Heat pump	Domestic hot water	Free cooling	Heat recovery	Motor cond.unit
Type compress. to manage	Hermetic steps	√	√	√	√	√	√	√
	Screw steps	√	√	√	√	√	√	
	Screw Stepless	√	√	√	√	√	√	
	Inverter 0/10 volt	√	√	√	√	√	√	
	Inverter Refcomp	√	√	√	√	√	√	
Type of Thermo-regulation	Proportional Step	√	√	√	√	√	√	√
	Neutral zone	√	√	√	√	√	√	
	Step-less	√	√	√	√	√	√	
	Inverter	√	√	√	√	√	√	
Principal Functions	Anti-freeze	√	√	√	√	√	√	√
	Auxiliary relay	√	√	√	√	√	√	√
	Energy saving	√	√	√	√	√	√	√
	Dynamic setpoint	√	√	√	√	√	√	√
	Auxiliary heating	√	√	√	√	√	√	√
	Evaporator pump	√	√	√	√	√	√	√
	Condenser pump	√		√	√	√	√	
	Condensation fan		√	√	√	√	√	√
	Pump down	√	√	√	√	√	√	√
	Unloading	√	√	√	√	√	√	√
	Defrost			√	√			
	Anti-legionella				√			
Family groups to consider		CF -CO- IO- RA- CA- AL- ES-SD- US -PA- PD -UN	CF -CO- IO- RA- CA- AL- ES-SD- US -PA- PD -UN - FA	CF -CO- IO- RA- CA- AL- ES-SD- US -PA- PD -UN - FA -DF	CF -CO- IO- RA- CA- AL- ES-SD-US -PA-PD - UN -FA - DF -FS	CF -CO- IO- RA- CA- AL- ES-SD- US -PA- PD -UN -FA -FC	CF -CO- IO- RA- CA- AL- ES-SD- US -PA- PD -UN - FA- AR	CF -CO- IO- RA- CA- AL- ES-SD- US -PA- PD -UN - FA

3.1 MAIN FUNCTIONS

Management of the cooling/heating unit with:

- Single-circuit up to three compressors
- Two circuits up to 6 compressors
- Screw compressors

Start-up of configurable compressors:

- Direct
- Part winding
- Star delta (not available)

Compressor management with inverter:

- 1 compressor per circuit

Configurable soft start-ups:

- Start-up with unloading valve
- Idle running valve

Unloaders management:

- continuous working
- step working
- modulating working (screw compressors)

Compressors rotation and temperature control configurable from parameter:

- by fix sequence
- by FIFO sequence
- by balance
- by saturation

Step-less compressor management:

- with neutral-zone regulation

Compressors liquid injection function

- Control with dedicated PTC probe

Compressors discharge high temperature alarm function

- Control with dedicated PTC probe

Complete management of two water side pumping units:

- 2 pumps evaporator side
- 2 pumps condenser side

Customised default display of all variables

- Temperatures
- Pressures

Other displays available

- Status of the digital inputs
- Compressor running hours
- N° compressor start-ups
- Evaporator/condenser water pump running hours
- Time remaining before defrost
- Percentage of the proportional outputs
- Compressors discharge temperature

Reset alarms using customised password

- Historical alarms
- Compressor thermal overload alarms

Possibility of enabling/disabling the individual circuit

- Allows maintenance of the circuit
- Allows "partialised" working of the unit

Possibility of enabling/disabling the individual compressor

- Maintenance of the individual compressor
- Malfunction

Complete management of pump down function:

- With dedicated pressure switch
- Timed
- Via the low pressure switch
- Via the low pressure transducer

-

Circuit unloading function:

- From high evaporator inlet water temperature
- From low evaporator outlet water temperature
- From high condensing temperature/pressure
- From low evaporator pressure

Anti-freeze function:

- From low evaporator temperature
- From low condenser temperature
- From digital input as anti-freeze alarm
- Active with four heaters

Domestic hot water production function:

- From low temperature of domestic hot water control probe
- Take effects by compressors and heaters working with step regulation
- Manage domestic hot water pump and valves

Anti-legionella function:

- From RTC time band setting
- Take effects by domestic hot water production

Solar panels water pump management:

- From high solar panel NTC temperature probe temperature
- Manage solar panel water pump and solar coil enabling/exclusion ON/OFF valve

Free-cooling function:

- From high system water inlet temperature and low external air temperature
- Manage Free-cooling ON/OFF valve and Free-cooling ON/OFF fan
- Manage modulating output free-cooling mixer valve and hot water three-way valve

Controlled loads maintenance signal function:

- Compressors
- Evaporator pumps
- Condenser pump

Circuit auxiliary relay function:

- Four completely configurable relay outputs, also released from normal working of the unit controlled, managed by means of NTC or PTC temperature probes or with 4÷20mA – 0.5 Volt pressure transducer

Weekly working in energy saving mode:

- Up to three daily time bands (devices with RTC option)
- From digital input

Weekly working with automatic switch on and switch off:

- Up to three daily time bands (devices with RTC option)

Dynamic set-point function:

- Managed by NTC or 4÷20mA input

Changeover function:

- Automatic changeover between cooling and heating by NTC input

Remote OFF function:

- From configurable digital input

Remote heating cooling function:

- From digital input with configurable logic

Supply fan hot start function:

- Air/air unit

Defrost management:

- In temperature in pressure or with both (combined control)
- Forced defrost for start-up with low external air temperatures
- From digital input or timed
- Manual using the relevant key
- By hot gas or fan only

Auxiliary heating function:

- With integration heaters

- **Two outputs for the proportional control of the condensing fan speeds via external module (inverter or single/three phase phase cut) with configurable signal:**

- 0÷10 Volt
- 4÷20 mA

Complete alarms management:

- With internal data logger alarms (up to 100 events)

Work as motor-condensing unit:

- Response to cooling/heating request from digital input
- Capacity controlled by digital input
- No temperature regulation

Expansion module:

- 1 IPROEX60D
- for each expansion module, including: 3 DI, 7 AI, 3 AO and 6 DO.

Electronic thermostatic valve driver:

- up to 2 XEV20D
- driving up to 4 electronic expansion valves
- each XEV20D includes 4 probes.

4. SUPERVISION FROM LOCAL AND REMOTE

Supervision/tele-assistance/remote monitoring for complete control and supervision from local and remote

- By means of network output with ModBus TCP / IP protocol (INTERNET / INTRANET)
- Directly by telephone line (MODEL WITH INTERNAL MODEM)
- Indirectly by means of GSM modem or XWEB serial modem (MODEL WITH RS232 OUTPUT PREPARATION)
- Via RS485 slave output with ModBus protocol to Dixell XWEB300D / XWEB500D supervision systems

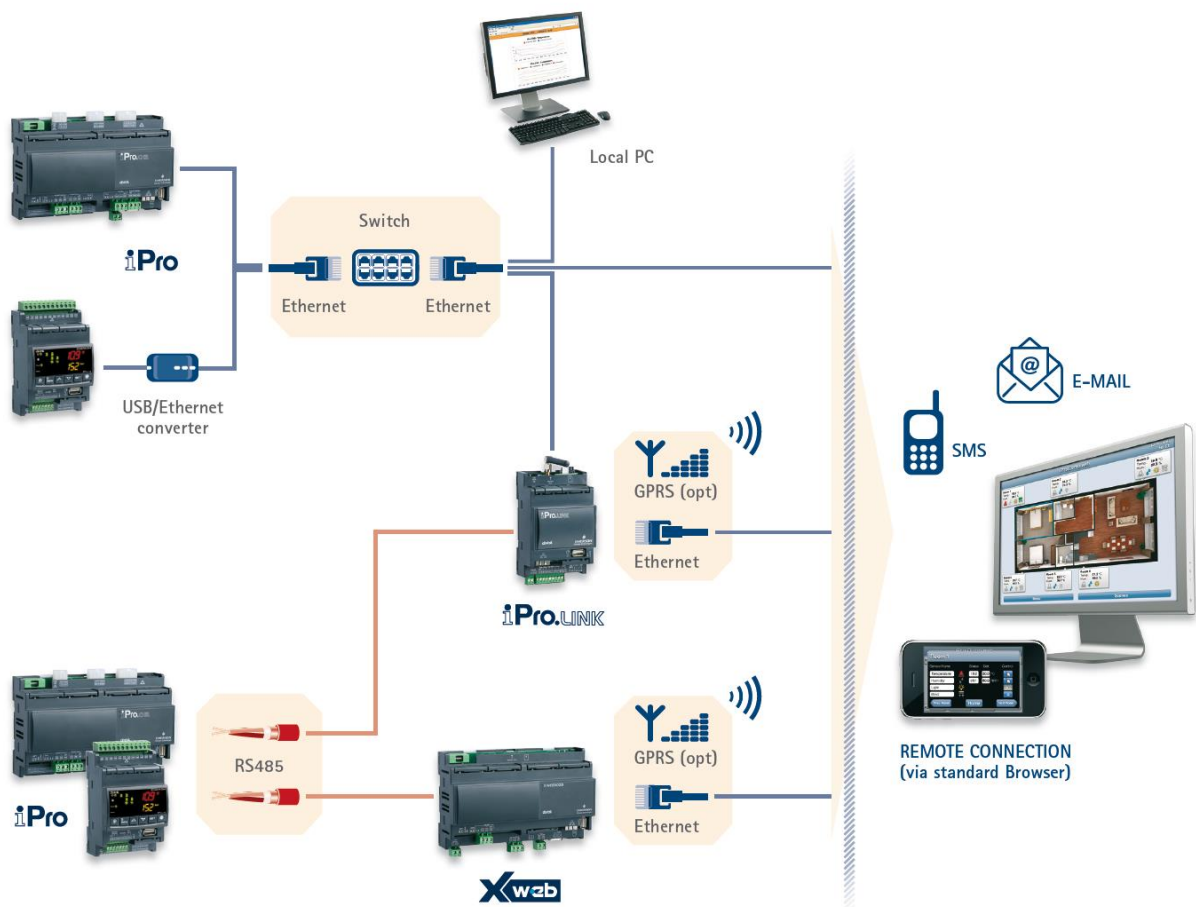

5. USER INTERFACE VISOGRAPH 1.0 AND VISOGRAPH 2.0

Using the VISOGRAPH LCD graphic keyboard, it is possible to monitor and modify the status of the unit. User can select UI type via configuring parameter DP12 in Wizmate with administrator authority. The options are: VISOGRAPH 1.0, VISOGRAPH 2.0 and VISOTOUCH.



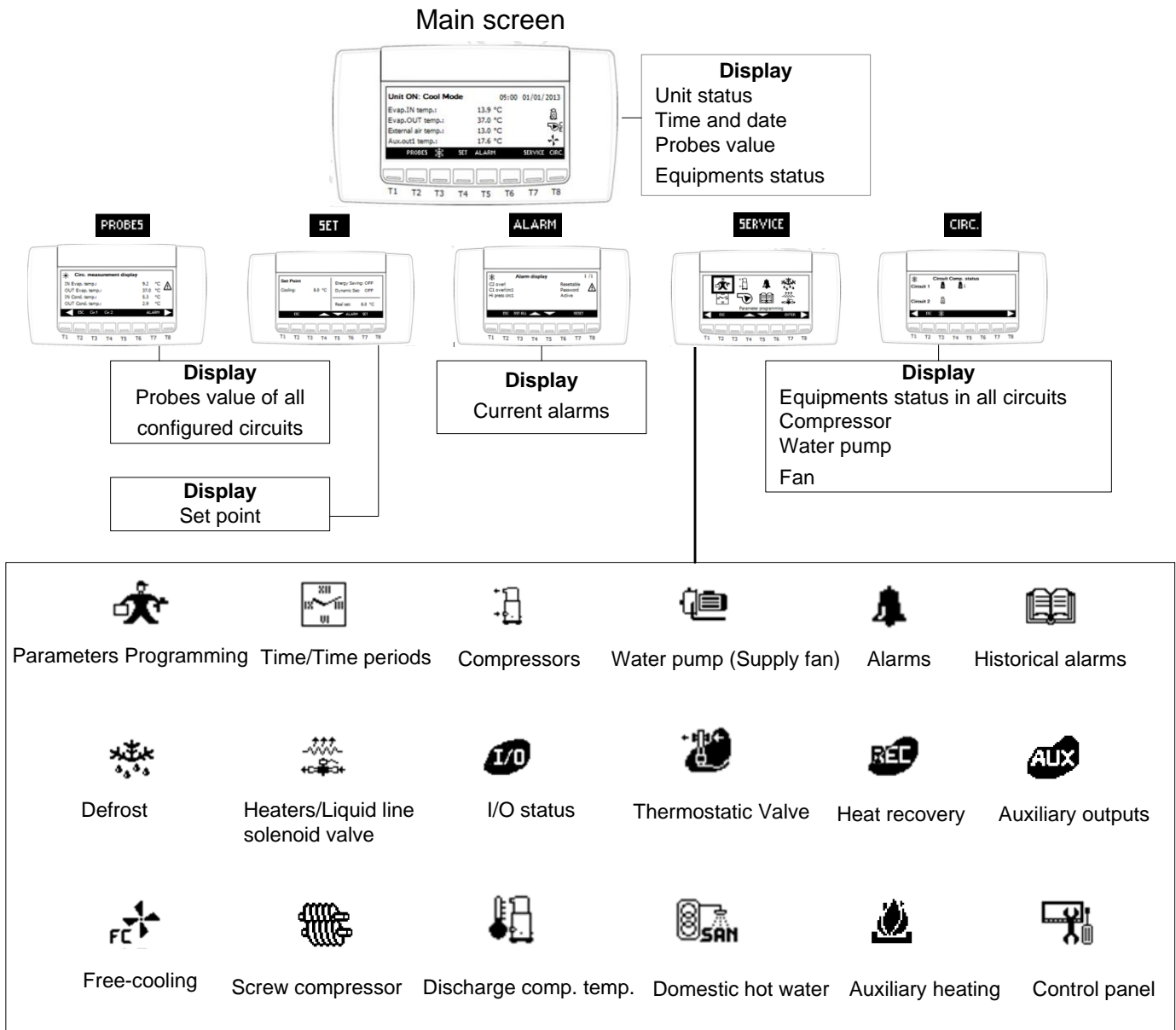

VISOGRAPH 1.0 and VISOGRAPH 2.0 are different in hardware and firmware, but they are showing the same screens. The only difference is VISOGRAPH 2.0 can manage also two LEDs on the front panel in addition.

- Green LED: Always ON after power on.
- Red LED: ON when have alarm active or resettable.

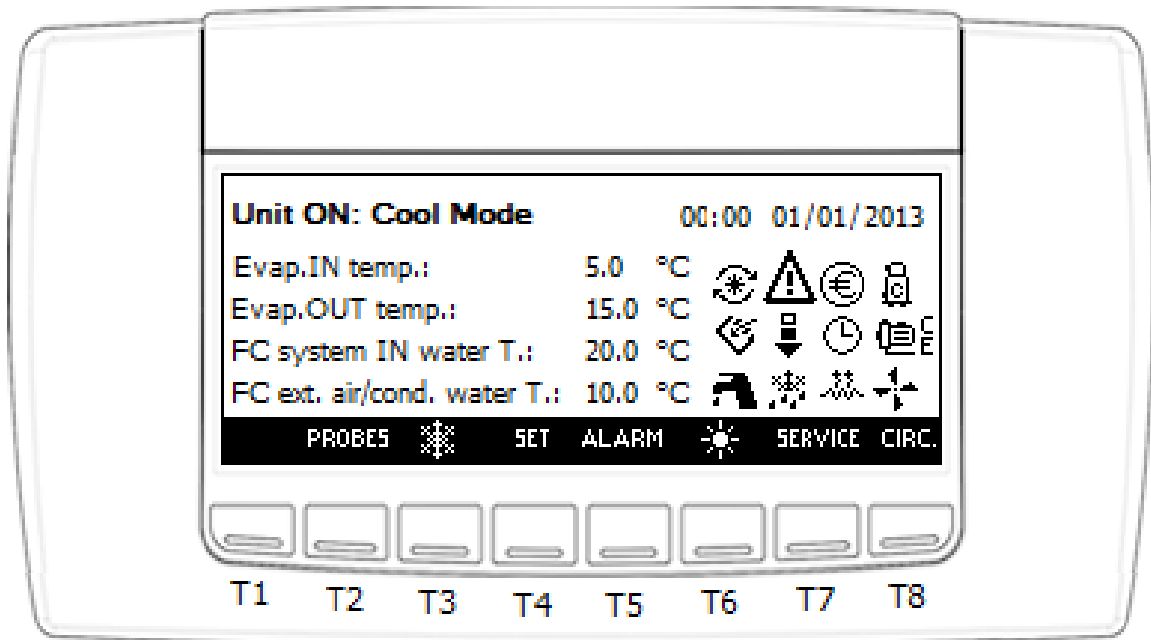









The information that appears in the main screen is:



-  to indicate that at least one of the compressors is working.
-  to indicate that the evaporator pump  and/or the condenser pump  are working (the condenser pumps are present in the case of WATER-WATER configuration).
-  to indicate that the condenser fans are working (in the case of AIR-AIR or AIR-WATER unit configuration)

If the alarms occur or particular working modes sub-enter, the following icons will be shown on the main screens:

-  flashing to indicate that an alarm is active
-  to indicate that the UNLOADING mode is in progress
-  on to indicate that the defrost cycle is in progress, flashing during the count down
-  to indicate that the anti-freeze/support heaters are active
-  automatic switch-off and/or energy saving is enabled during the current day
-  to indicate that the unit is working within the energy saving period or that the dynamic set-point is active
-  to indicate that the domestic hot water production is active
-  to indicate that the auxiliary heating is active (it will display in the same place with domestic hot water production icon)

On unit power-on, the main screen will be the following (Displayed probes are selectable):

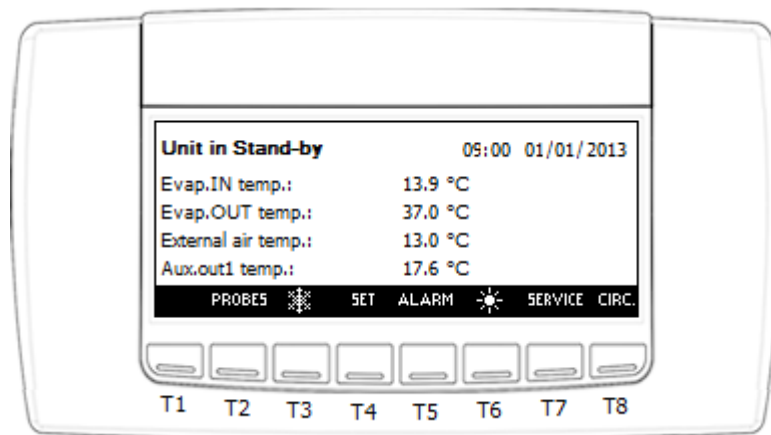

When the keyboard shows “Remote OFF”, “OFF through clock” or “Stand-by”, they all mean the unit is OFF now but with different causes.

When the keyboard shows “Unit ON: Cool Mode” or “Unit ON: Heat Mode”, they all mean the unit is ON now but in different working mode.

Below find a typical screen during working in chiller mode:

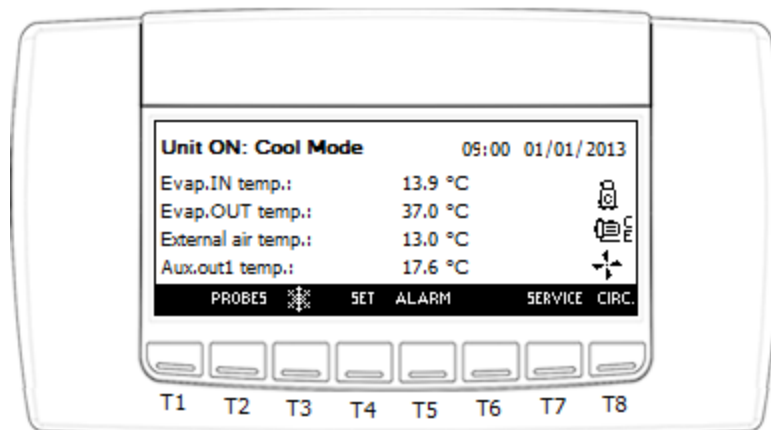

5.1 HOW TO SWITCH ON/OFF THE UNIT AND CHANGE CHILLER/HEAT PUMP WORK MODE FROM KEYBOARD

Firstly, we will talk about No Motor Condensing Unit. Set Par **CF04** = 0.

UNIT SWITCH-ON AND SWITCH-OFF CAN TAKE PLACE:

- From the keyboard
- From digital input configured as remote ON/OFF
- By time bands (see unit switch on/off by RTC)

5.1.1 Unit Switch-ON/OFF From The Keyboard

The unit can be configured as chiller only, heat pump only or as chiller with heat pump mode by par CF02. For different type of units, the switch ON/OFF procedures are different.

CF 2	Selection of unit working 1 = chiller only 2 = heat pump only 3 = chiller with heat pump	1	3		
-------------	---	---	---	--	--

Note: If user wants change CF02 value, please switch off the unit to "Stand-by" status first. Otherwise, it may take no effect.

When only the heating is enabled, the ACF1 alarm is not generated if the reverse valves in the envisioned circuits are not configured.



SWITCH THE UNIT ON/OFF IN COOLING- HEATING MODE FROM THE KEYBOARD

The configuration should be:

CF04 = 0, (not Motor condensing unit)



CF02 = 3, (chiller with heat pump)

SP09 = 0, (from the keyboard)



In the beginning, the device is in stand-by mode, and the keys  and  are all visible. One is placed in key 3, another is placed in key 6, depends on Par SP08.





(The keyboard has eight keys in all. They are key 1, key 2, key 3...and key 8 from left to right.)



SP08 = 0:  placed in key 3,  placed in key 6.

SP08 = 1:  placed in key 3,  placed in key 6.

No matter how to place, key 3 is always used for cooling mode. Key 6 is always used for heating mode.

Suppose SP08 = 0, press key  (key 3) can switch on the unit to work in cooling mode. At this moment  is hidden.

Press the key  again, the unit is switch OFF and return to status stand-by. The key  and  are all visible now. In this case, user can press key  to switch to heating mode or press  to restart the cooling mode.

The device is in stand-by when both  and  keys are visible. The stand-by mode is obtained every time that the unit is off from cooling or heating working mode. Also in stand-by mode, the controller gives the possibility to:

- display the variables detected
- manage the alarm situations, displaying and signalling them.

When unit is ON in chiller mode, the status in the screen is "Cool Mode":

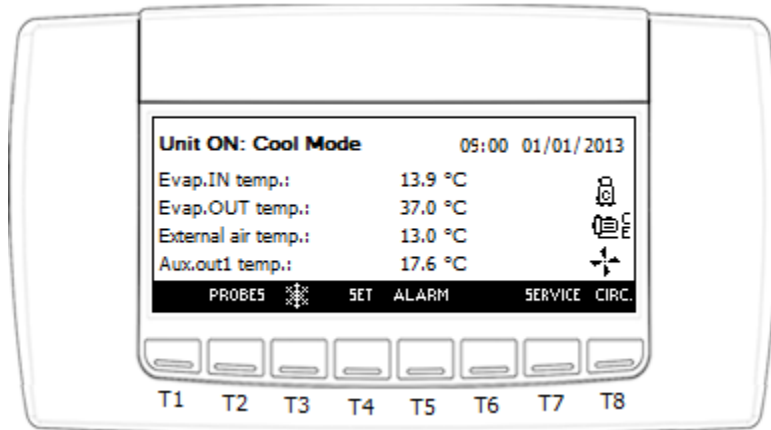

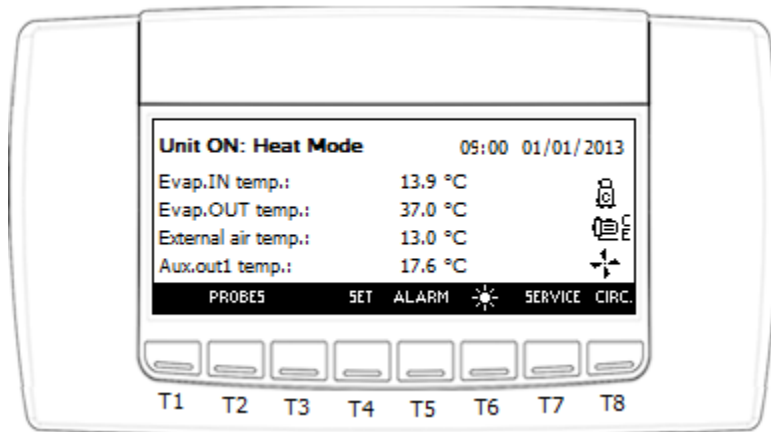

When unit is ON in heat pump mode, the status in the screen is “Heat Mode”:





SWITCH THE UNIT ON/OFF IN COOLING MODE FROM THE KEYBOARD

The configuration should be:
 CF04 = 0, (not Motor condensing unit)
 CF02 = 1, (chiller only)
 SP09 = 0, (from the keyboard)

In the keyboard, key 3 is always visible and key 6 is hidden. Key 3 will be shown as  when SP08 = 0 and shown as  when SP08 = 1. Press key 3 can switch the device status between cooling mode and stand-by.

SWITCH THE UNIT ON/OFF IN HEATING MODE FROM THE KEYBOARD

The configuration should be:
 CF04 = 0, (not Motor condensing unit)
 CF02 = 2, (heat pump only)
 SP09 = 0, (from the keyboard)

In the keyboard, key 6 is always visible and key 3 is hidden. Key 6 will be shown as  when SP08 = 0 and shown as  when SP08 = 1. Press key 3 can switch the device status between heating mode and stand-by.

5.1.2 Unit Switch-ON/OFF From Digital Input

If the unit is switch off by remote digital input, the screen will be:

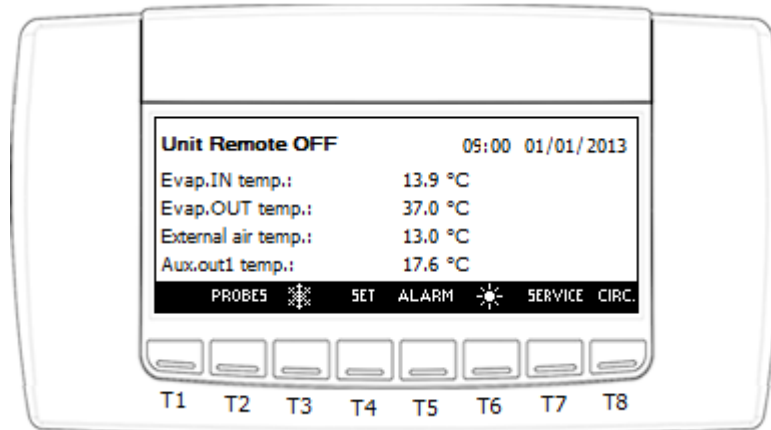

From digital input configured as **remote ON/OFF** (DI type =1). When deactivated, on the basis of the polarity selected, the input determines the OFF status

- It has priority with respect to the keyboard
- The unit can only be switched-on and off with input activated
- With input activated, the device goes back to the status previous to activation

5.1.3 Select The Working Mode: Chiller-Heat Pump

The parameter SP09 allows selecting and enabling the selection of the unit switch-on mode in the three working modes.

Par SP09 = 0

The switch-on selection of a unit configured for cooling and heating takes place from the keyboard.

AUTOMATIC WORKING SELECTION IN COOLING-HEATING MODE FROM DIGITAL INPUT

Par SP09 = 1

The switch-on selection of a unit configured for cooling and heating takes place from digital inputs configured as **Remote cooling/heating**(DI type=2). With digital input activated, cooling mode is selected, with digital input deactivated, heating mode is selected.

- The selection is enabled if a digital input is configured as cooling request or as heating request. If no digital input has been configured, the unit **REMAINS in stand - by**
- the cooling/heating selection from the keyboard is disabled. The unit can only be switched-on/off in the working status selected from the digital input
- CF02 is the precondition. If only CF02=3 the cooling/heating selection from digital input is available. Otherwise, the device working mode will be set by CF02.
- In the keyboard, keys for cooling/heating will be shown according to digital input status. E.g., digital input=cooling, key 3 is visible and key 6 is hidden. By pressing key 3, the unit can switch between cooling and stand-by.

AUTOMATIC WORKING SELECTION IN COOLING-HEATING MODE FROM ANALOGUE INPUT

Par SP09 = 2

Selection from analogue input (change over function) has priority with respect to the digital input. For temperature of the external air included in the SP11 differential, it is allowed to change the working mode from the keyboard.

5.1.4 Change Over Function

SP10	Automatic chiller / heat pump mode changeover setting	-50.0 -58	110 230	°C °F	Dec int
SP11	Automatic chiller / heat pump mode changeover differential	0.1 1	25.0 45	°C °F	Dec int

The status change over can only take place if these necessary conditions are present at the same time, otherwise the unit **REMAINS in stand - by**:

1. CF02=3 (chiller with heat pump)
2. SP09=2 is an NTC probe configured as an **External air temp / dynamic set point / auxiliary heating / change over NTC temperature probe** (AI type=19)
3. the regulation probe selected must not be in error conditions

AUTOMATIC CHANGE OVER REGULATOR GRAPHICS

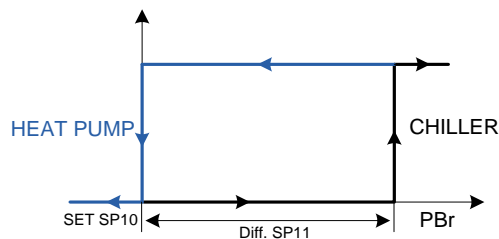

Parameters that regulated the change over function

SP10 allows setting the change over set point. If the selection of the working mode from analogue input is enabled, it represents the temperature value detected by the regulation probe below which the device imposes the working in heating mode

SP11 allows setting the change over differential. If the selection of the working mode from analogue input is enabled, it represents the temperature differential on the basis of which the device imposes the working in cooling mode

For temperature of the external air included in the SP11 differential, it is allowed to change the working mode from the keyboard.

NTC external air temperature regulation NTC probe > SP10+ SP11, the unit is switched-on in cooling mode.

NTC external air temperature regulation NTC probe < SP10, the unit is switched-on in heating mode.

5.2 UNIT SWITCH ON/OFF BY RTC

5.2.1 Working With Clock Disabling Digital Input

ES 1	Start of working time band 1 (0-24)	0	24.00	Hr	10 Min
ES 2	End of working time band 1 (0-24)	0	24.00	Hr	10 Min
ES 3	Start of working time band 2 (0-24)	0	24.00	Hr	10 Min
ES 4	End of working time band 2 (0-24)	0	24.00	Hr	10 Min
ES 5	Start of working time band 3 (0-24)	0	24.00	Hr	10 Min
ES 6	End of working time band 3 (0-24)	0	24.00	Hr	10 Min
ES18	Monday automatic shutdown time band	0	7		
ES19	Tuesday automatic shutdown time band	0	7		
ES20	Wednesday automatic shutdown time band	0	7		
ES21	Thursday automatic shutdown time band	0	7		
ES22	Friday automatic shutdown time band	0	7		
ES23	Saturday automatic shutdown time band	0	7		
ES24	Sunday automatic shutdown time band	0	7		

If the unit is switch off during switch-off time bands, the screen will be:

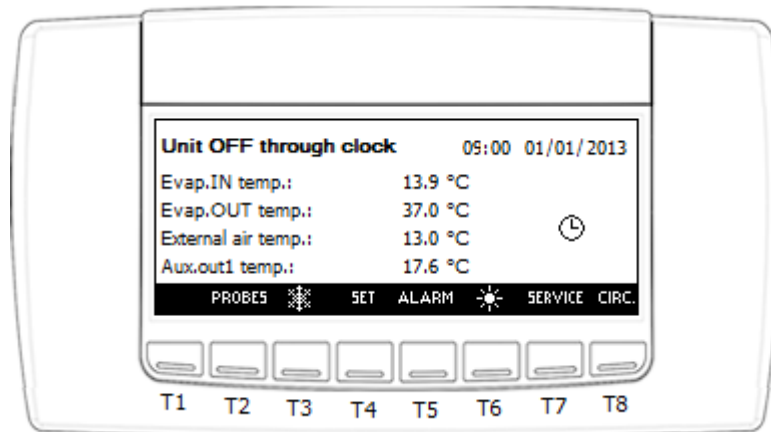

If a digital input is configured as **Digital input working in RTC automatic activation (time band)/manual** (DI type=46) and is active, the working via the internal clock is disabled. Otherwise, if this digital input is not configured or configured but not active, enables the working via the internal clock.

The unit is forced to switch off within the time band.

Set the time band with Par ES01-ES06, and select weekly time band by Par ES18-ES24. If current time is inside the setting band, the unit will be shut off automatically, and the keyboard shows "Unit OFF through clock".

The RTC time band also can be configured from keyboard.

Enter into the **TIME/TIME PERIOD** screen from **SERVICE** menu.

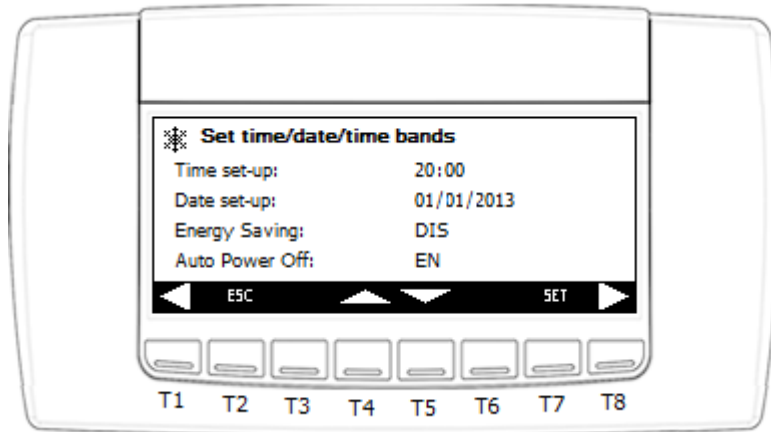

Enable the **Auto Power Off** option, set **Time band N1/N3** in page 2.

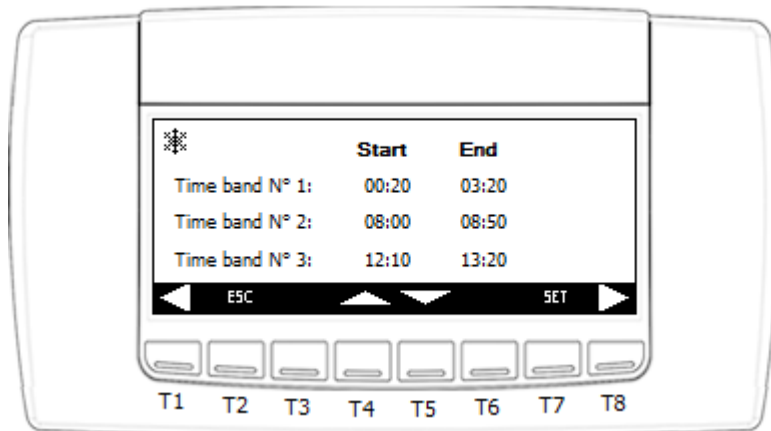

Select time band from **Monday** to **Sunday** in the next pages' last column **Auto On-Off**.

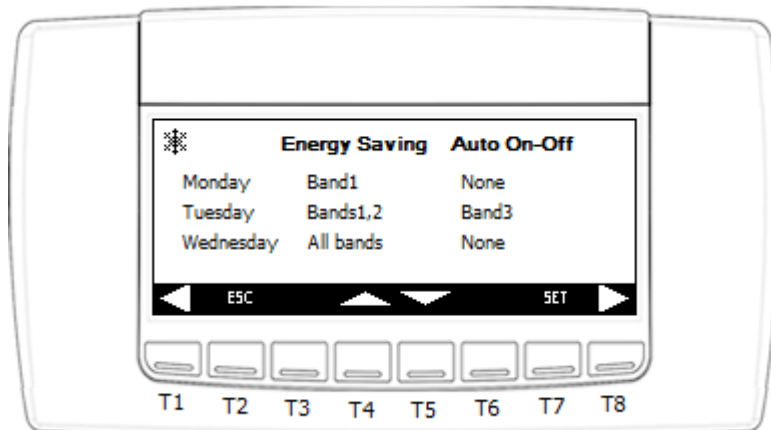

5.2.2 Working With “Ventilation Only” Digital Input (Air-Air Unit Only)

If the unit has been configured as AIR-AIR, during clock off, it is possible to decide whether to enable ventilation or not. When ventilation enabled, the screen will be:

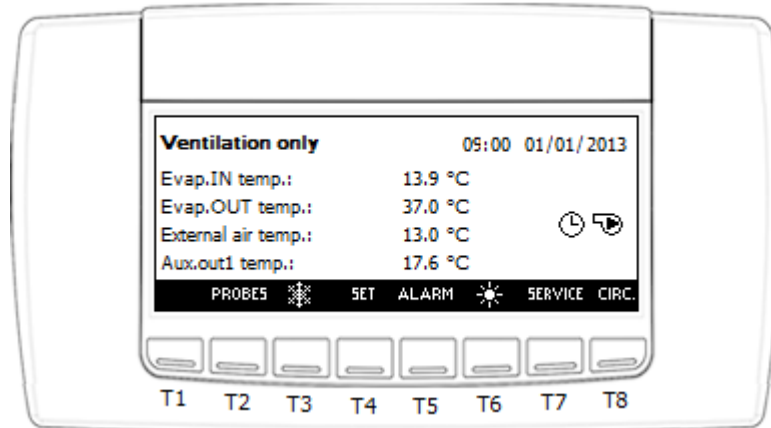

This working mode is only enabled if the clock is present and enabled.

Set CF01=0, select air/air unit.

Set ES01-06, ES18-24 to enable the function automatic shutdown by RTC.

If a digital input is configured as **Digital input working with supply fan only** (DI type=47) and is active, when current time is inside the automatic shutdown time band, the unit will work in “Ventilation only” mode.

In “Ventilation only” mode, only relay configured as supply fan is enabled.

After current time goes out of the automatic shutdown time band, the unit will back to normal working mode.

WARNING: In ventilation only mode, the supply fan will forced to active if unit is on. When the unit is placed in remote off or stand-by, supply fan will switch off after the delay time set in par PA03.

5.2.3 Working With Unit In OFF From RTC If ON Is Forced From Key

ES25	Unit maximum working time in OFF from RTC if forced in ON from key	0	250	Min	10 Min
-------------	--	---	-----	-----	--------

When the unit is OFF by RTC, user can use keyboard or digital input to force the unit ON. However, the ON time can't be longer than the time set by Par ES25. After ES25 time, the unit will be forced back to OFF status.

During ES25 time, user can manually switch OFF the unit by keyboard or digital input.

5.3 OPERATION IN CONDENSING UNIT WORKING MODE

If CF04 = 1, the unit will work as Motor-condensing unit.

CF 4	Motor-condensing unit 0 = no 1 = yes Temperature control, dynamic set point and energy saving functions are automatically disabled when CF04 = 1	0	1		
-------------	---	---	---	--	--

WARNING:

In condensing unit working mode the temperature control, dynamic set-point function and energy saving function are disabled automatically

In condensing unit working mode, the cooling/heating capacity is only controlled by digital input configured as **Digital input power step1 request(motor-condensing unit)** (x can be 1 to 8. DI type = 51-58).

5.3.1 Working With Digital Input Configuration As Temperature Control Request

Unit configured as motor-condensing CF04 = 1.

Configure DI as **Digital input temperature control request (motor-condensing unit)**. (DI type = 48)

- With DI contact NOT ACTIVE unit in **OFF**
- With DI contact ACTIVE unit in **cooling/heating**

With DI contact active, user can select the cooling or heating working mode by parameter CF02, SP09 and keyboard. The capacity steps will be called by DI configured as **Digital input power step1 request(motor-condensing unit)** (x can be 1 to 8. DI type = 51-58) if resources are available in the circuit.

With DI contact active, user can switch ON/OFF the unit by the keyboard. With DI contact not active, the unit will always OFF.

5.3.2 Working With Digital Input Configured As Cooling Request

Unit configured as motor-condensing CF04 = 1, CF02=1 or 3.

Configure DI as **Chiller request digital input (motor-condensing unit)** (DI type= 49)

- With DI contact NOT active unit is **OFF**
- With DI contact active unit is **ON** in chiller mode

With DI contact active, unit works in chiller mode. The capacity steps, if available, will be called by DI configured as **Digital input power step1 request(motor-condensing unit)** (x can be 1 to 8).

With DI contact active, user can switch ON/OFF the unit by the keyboard. If the unit has been switched-off from the keyboard, user can re-start it by deactivated and re-activated the digital input.

5.3.3 Working With Digital Input Configured As Heating Request

Unit configured as motor-condensing CF04 = 1, CF02=2 or 3.

Configure DI as **Heat pump request digital input (motor-condensing unit)** (DI type= 50)

- With contact NOT active unit is **OFF**
- With contact active unit is **ON** in heat pump mode

With DI contact active, unit works in heat pump mode. The capacity steps, if available, will be called by DI configured as **Digital input power step1 request(motor-condensing unit)** (x can be 1 to 8).

With DI contact active, user can switch ON/OFF the unit by the keyboard. If the unit has been switched-off from the keyboard, user can re-start it by deactivated and re-activated the digital input.

Working error

If two digital inputs are configured as cooling request and heating request with both inputs active at the same time, the unit will be positioned in OFF mode.

5.4 HOW TO MODIFY THE INFORMATION PRESENT IN THE MAIN SCREEN

5.4.1 Select Probes For Display

To select the probes to display on the keyboard, modify the parameters from DP01 to DP04 (see Programming parameters paragraph).

5.5 SET KEY IN MAIN SCREEN

To set the set-point of the cooling and/or heating from the main screen, press **SET**. In this way, enter the set-point screen.

Chiller mode:

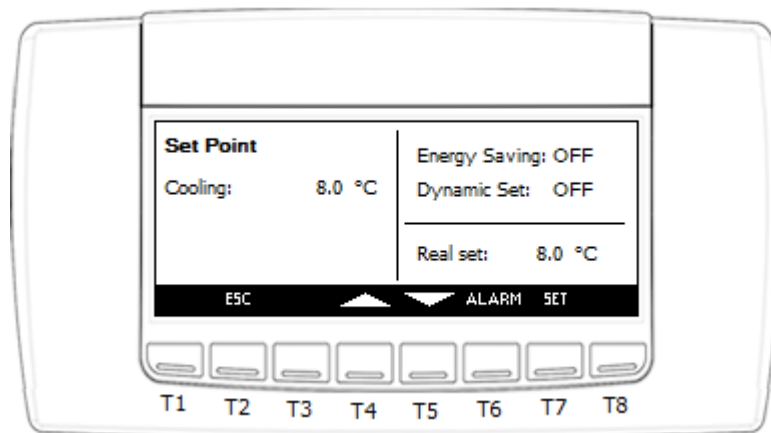

Heat pump mode:

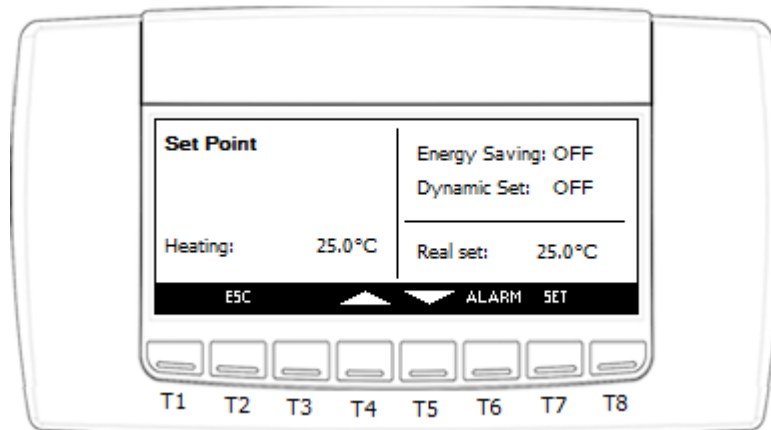

To modify the values, position the cursor on the element “Cooling” or “Heating” temperature and press the **SET** key:

- The element starts to flash.
- Increase or decrease the value using the **UP** and **DOWN** keys.
- Confirm the modification by pressing the **SET** key again.

The cursor will automatically position itself on the next element, to modify it repeat the operation just described.

In this screen it is also possible to verify (but not modify) whether the energy saving mode and dynamic set are active. If they are active, the **real set** may differ from the **Cooling** or **Heating** set. **Cooling (Heating)** set is always the same as par ST01(ST04), the **real set** represent the set-point value including the energy saving delta or of the dynamic set, and it is read only (can't be modified).

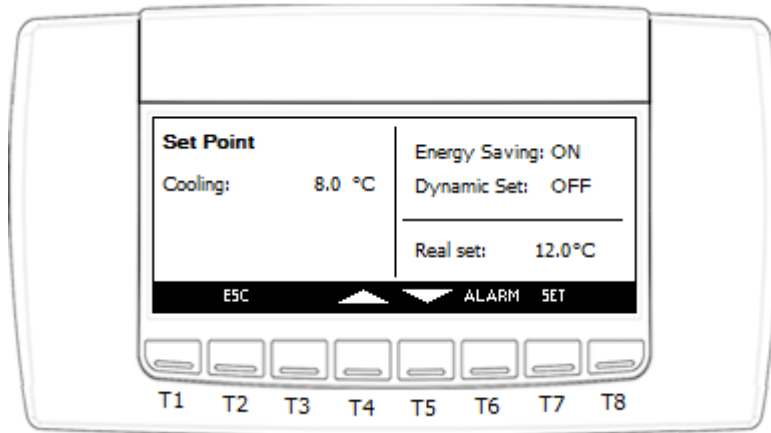

If heat recovery is enabled (RC01>0), the recovery set point will also be shown in this screen.

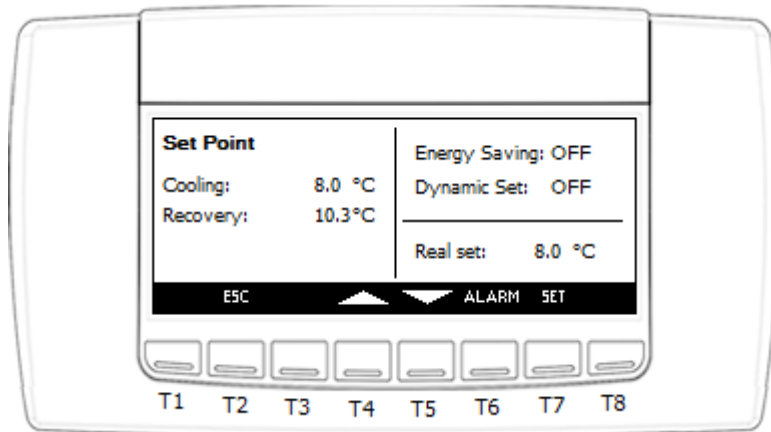

Press the **ESC** key several times to go back to the main screen.

5.6 PROBES KEY IN MAIN SCREEN

To see the configured probes value of the circuits, press the **PROBES** key in the main screen;

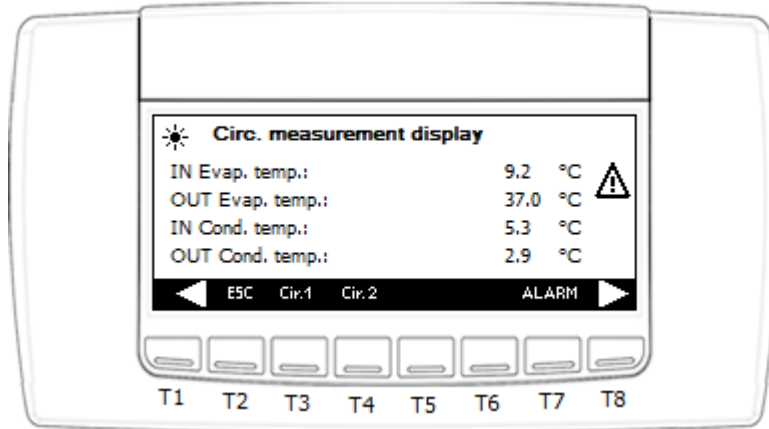

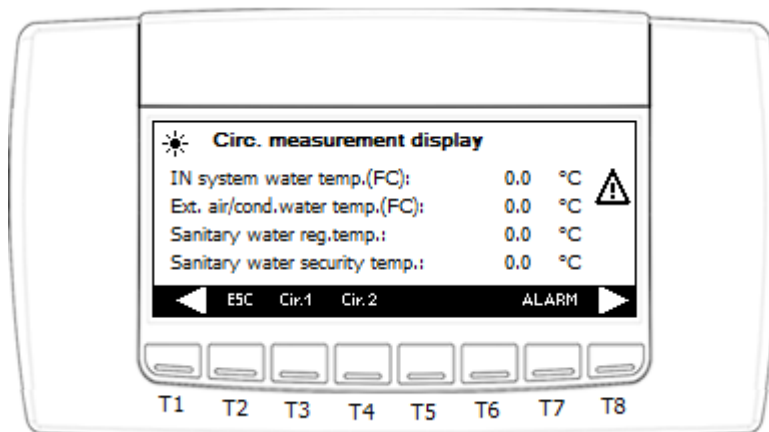

By pressing the  key, all of the relevant variables of the circuits can be seen.

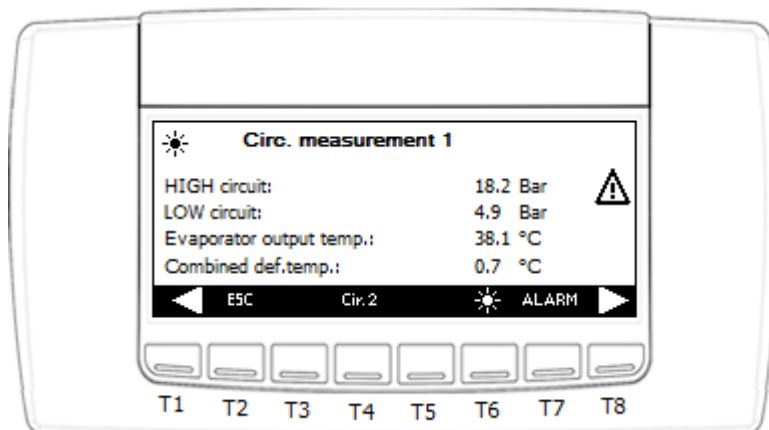

Warning: the probes displayed are only those configured.

In order to display the variables relative to the individual circuit, press the relative key. For example, if the variable of circuit 1 is to be displayed, press .



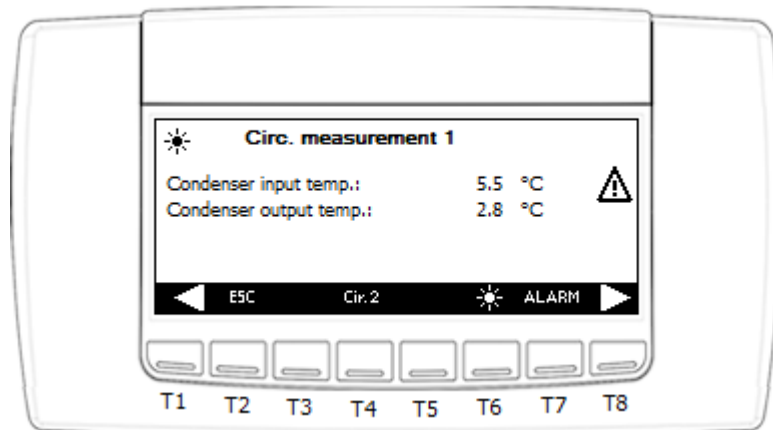

By pressing the  key, all of the other variables of the circuit selected can be seen.



Press the **ESC** key several times to go back to the main screen.

5.7 ALARM KEY IN MAIN SCREEN

When an alarm occurs, the display shows the flashing icon  and the buzzer starts to operate. Press any key to silence the buzzer.

Moreover, the alarms key starts to flash alternately with the icons  / ; By pressing the key, pass to the alarms in progress screen:

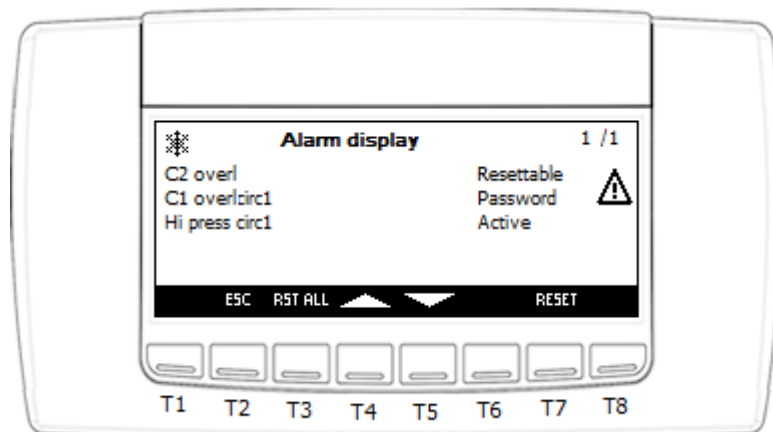

Three types of alarms can be present:



- Resettable → in this case, the alarm is not active and can be reset. Position the cursor on the alarm element and press **RESET**.
- Password → in this case, the alarm is not active, but a password is required to reset it.
- Active → the alarm is still in progress.

If there are several resettable alarms, instead of selecting them one by one, press **RST ALL** and they will all be reset together.

To reset an alarm that is protected by a password, operate as follows:

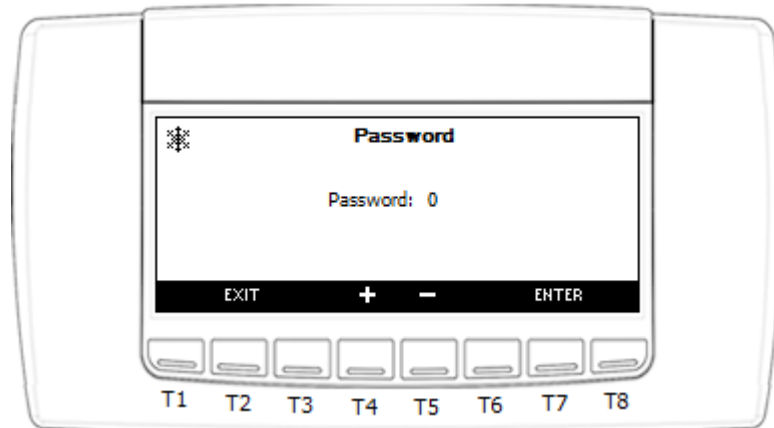
- Select the alarm marked by "Password".
- Press **RESET**.



- Via keys  and , set the password.
- Press **ENTER** to confirm.
- If the password is correct, the following message will be displayed:

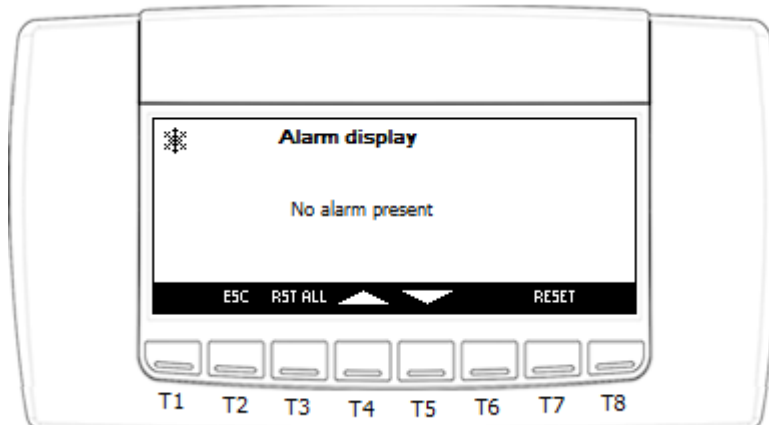
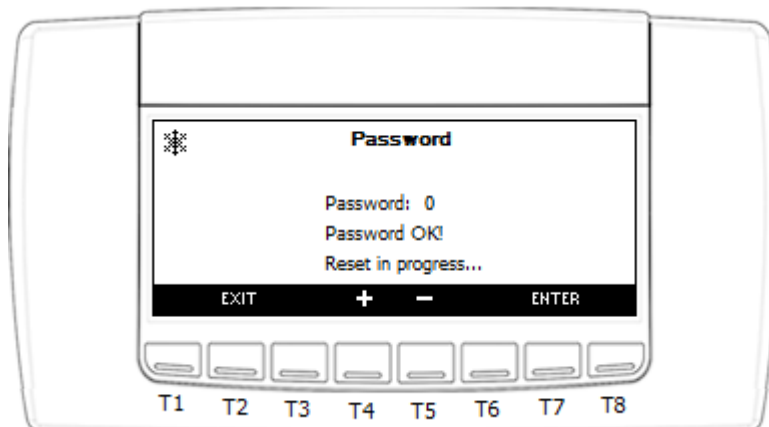

- If the password introduced is incorrect, the following message will be displayed:

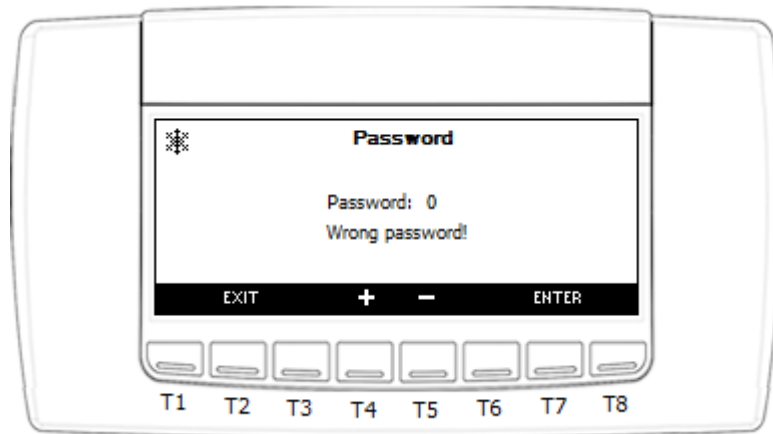

If the password is correct, after a few minutes you will go automatically back to the alarms screen.

5.8 CIRC KEY IN MAIN SCREEN

Using the **CIRC** key in the main screen it is possible to monitor the situation of the unit. The information refers to:

- Circuits compressors status; the screen shows the compressors present for each circuit and the activation status of the compressor (number of unloaders active). If the compressor has no number on the right, it means that it is at full power. In the screen below, circuit 1 has 2 compressors configured. Compressor 1 running at full power, compressor 2 running at 1st power step. circuit 2 has 1 compressors configured and it is not working now.

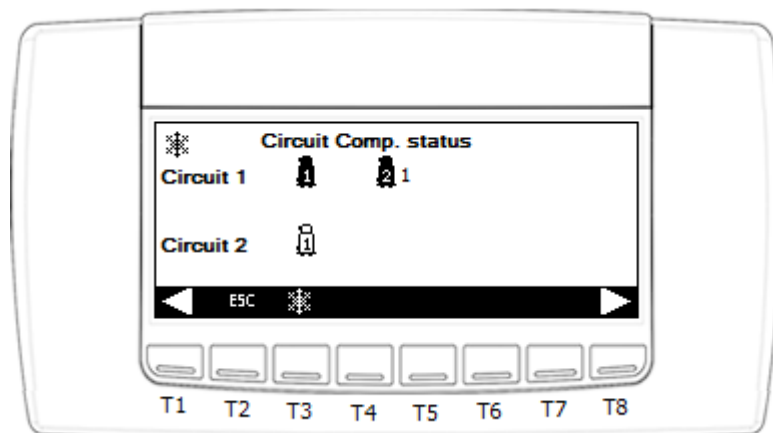

If unloading should be active, the maximum step number for unloading will be displayed.

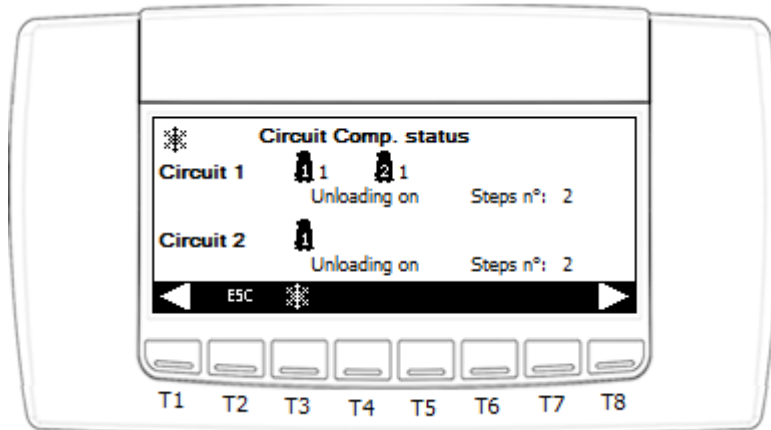

- Condensation-evaporation probes. The screen shows the condensation and evaporation pressures of every circuit present.

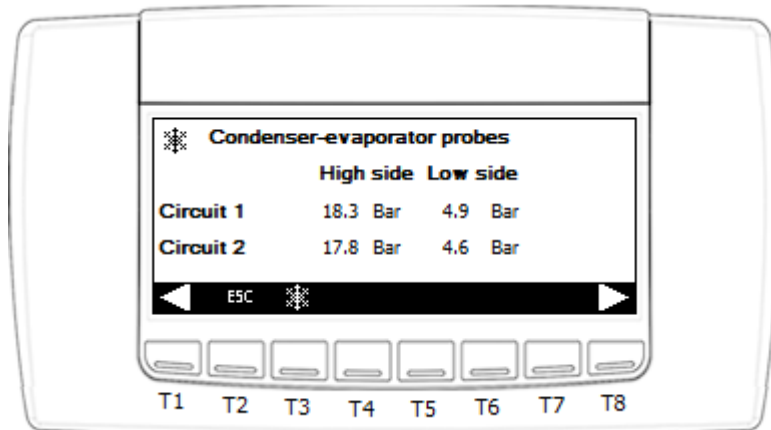

If the value of the parameter SP01 is equal to "0" or "2", the high side is represented with the temperatures.

- Status of the evaporator pump (or evaporator pumps if the support is present)

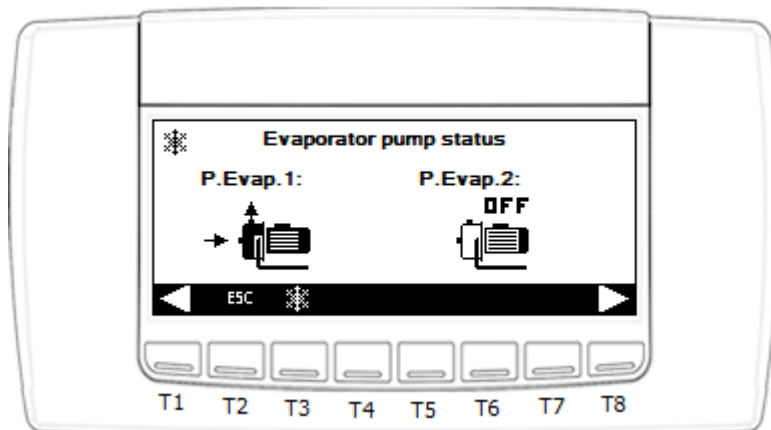

- Status of the supply fan

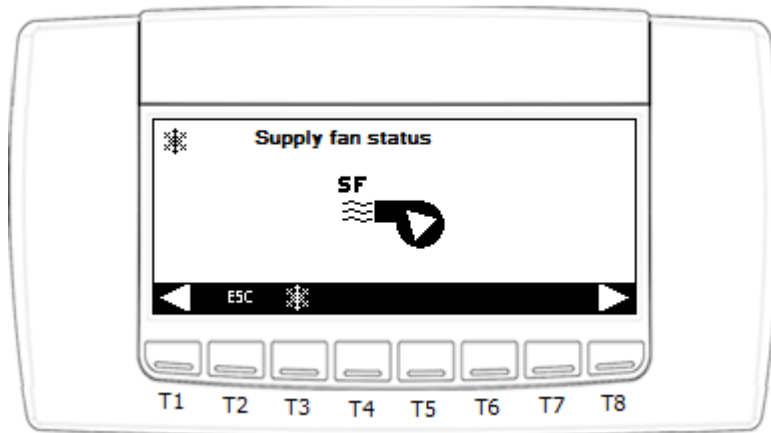

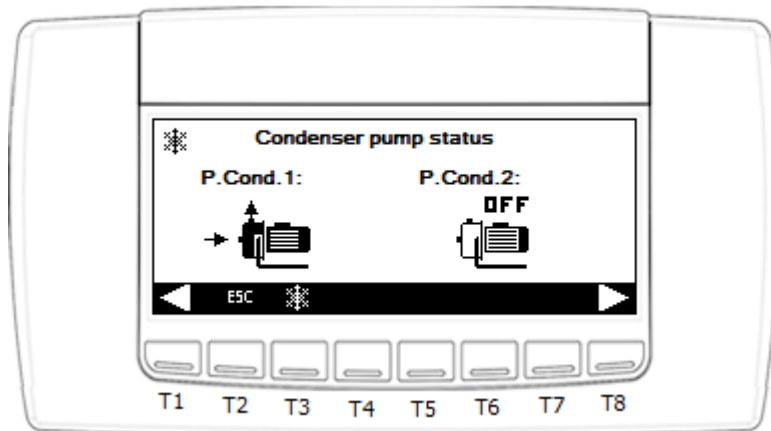

- Status of the condenser pump (or of the pumps if the WATER-WATER support is present)

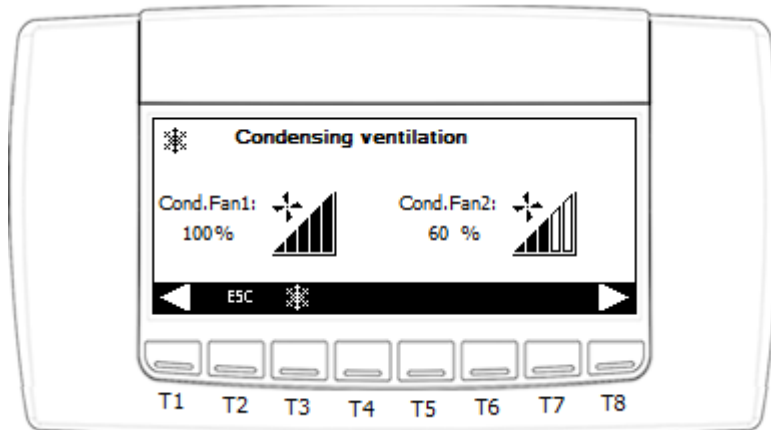

- Condensation fans (proportional or with steps - AIR-AIR or AIR-WATER)

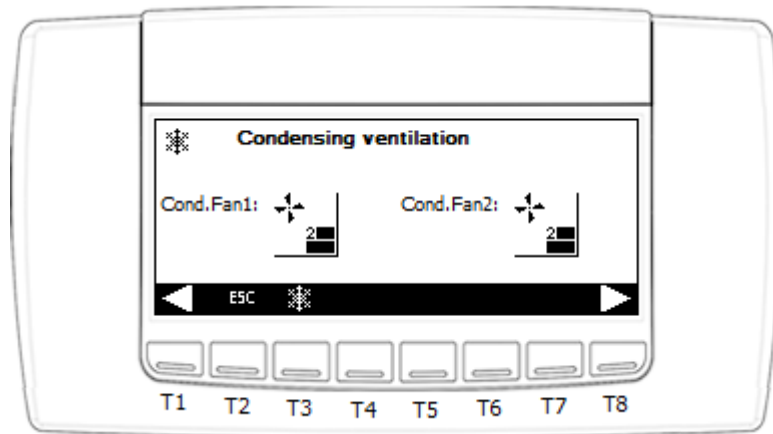



By pressing the  or  keys, pass from one screen to another.

- Refcomp compressor information
If Refcomp compressor is configured, press key **RefComp** to see relevant information.

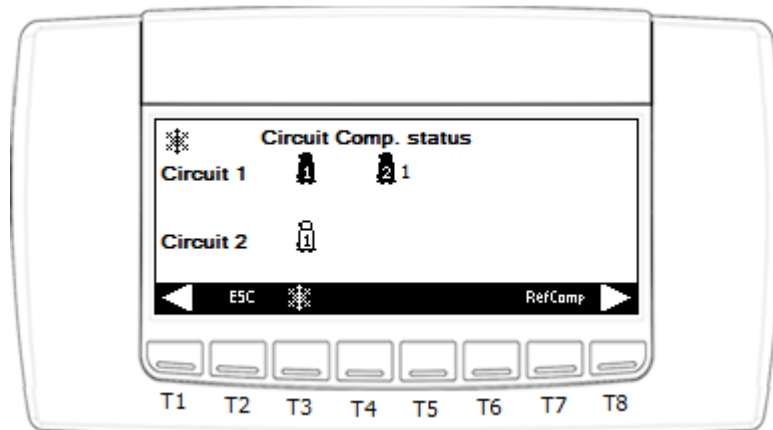

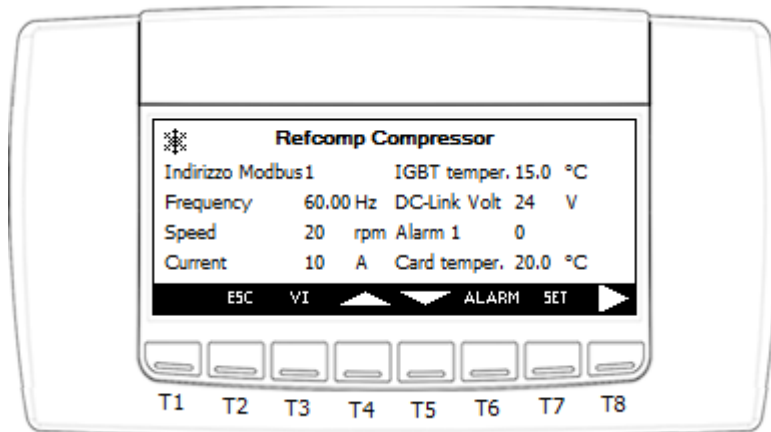

In the screen above, the modbus address is editable.

- Refcomp compressor valve status
Press key **VI** to see the valve status

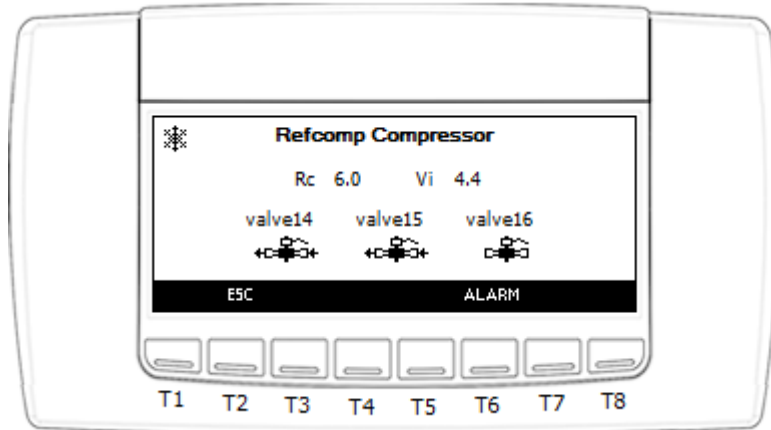

5.9 SERVICE KEY IN MAIN SCREEN

By pressing the SERVICE key, enter the configuration of:

- Parameters Programming
- Time/Time periods Programming
- Compressors
- Water pump (Supply fan)
- Alarms display
- Historical alarms
- Defrost
- Heaters/Liquid line solenoid valve
- I/O status (Inputs and Outputs)
- Thermostatic Valve
- Heat recovery function
- Auxiliary outputs
- Free-cooling
- Screw compressor
- Discharge compressor temperature
- Sanitary water (Domestic hot water)
- Auxiliary heating
- Control panel

The SERVICE menu is protected by password in 3 levels.

For 1st level, no password needed. Press key ENTER can enter in SERVICE menu directly.

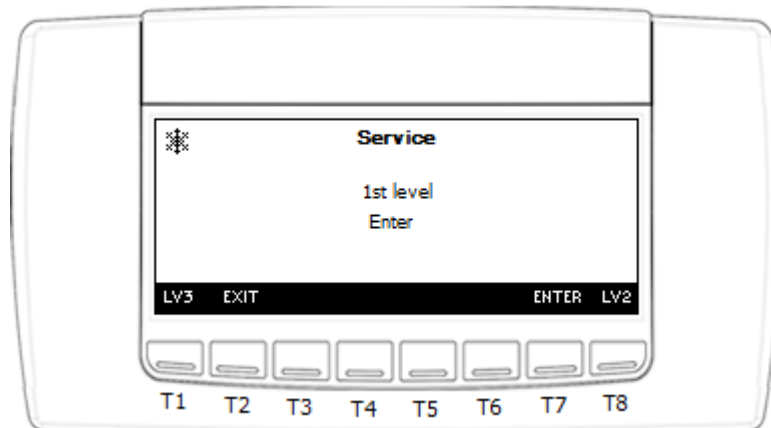

Press key LV2 or LV3 can switch to higher user level.

For 2nd and 3rd level, relevant password is required.

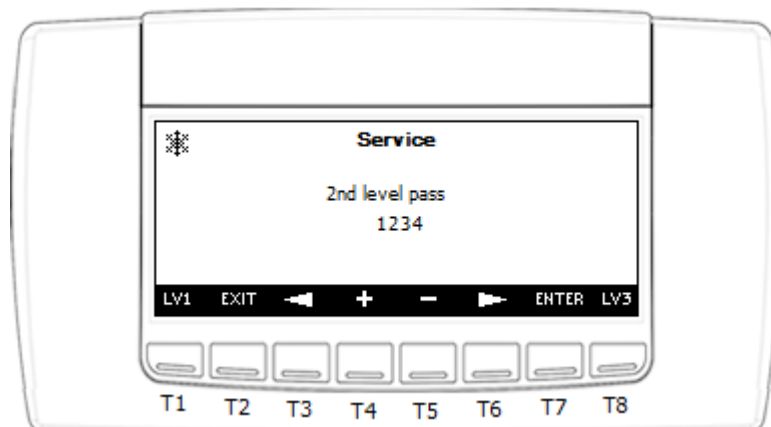

5.9.1 Parameters Programming

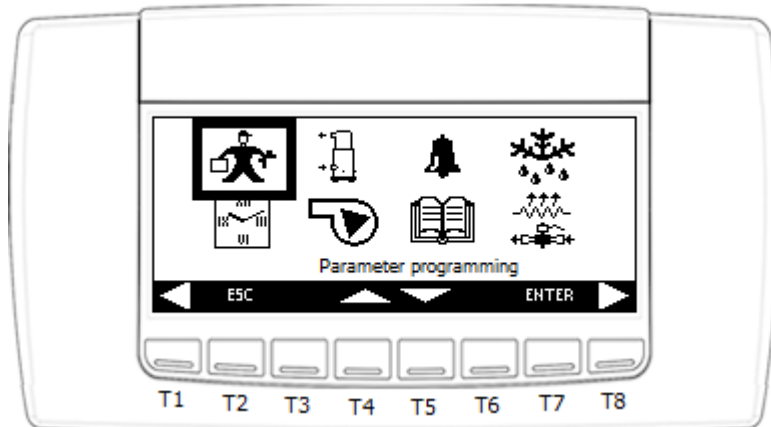

By selecting this menu it is possible to modify the value of the parameters depending on the Password level. The parameters are divided per groups with the following meaning:

Label	Meaning
ST	Display temperature control parameters
DP	Display variables to be shown on the keyboard
CF	Display configuration parameters
SP	Display parameters for machine set up
Sd	Display dynamic set-point parameters
ES	Display energy saving and automatic timed switch-on/off parameters
AH	Display auxiliary heating parameters
CO	Display compressor parameters
SL	Display stepless compressor parameters
PA	Display evaporator/condenser water pump parameters
Pd	Display pump down function parameters
Un	Display unloading function parameters
FA	Display ventilation parameters
Ar	Display anti-freeze heaters parameters
dF	Display defrost parameters
rC	Display heat recovery parameters
FS	Display production of domestic hot water parameters
FC	Display free-cooling function parameters
US	Display auxiliary output parameters
AL	Display alarm parameters
Et	Display parameters for the management of the electronic expansion valve
IO	Display inputs/outputs configuration parameters
CA	Display analog input calibration parameters
RA	Display analog input range parameters

According to user level, different amount of parameters are visible in the parameters programming screen.

- If user entered into SERVICE menu with 1st level, he can enter to see parameters in Level 1(Pr1).
- If user entered into SERVICE menu with 2nd level, he can enter to see parameters in Level 2(Pr2).
- If user entered into SERVICE menu with 3rd level, he can enter to see parameters in Level 3(Pr3).

In the selected level screen, user only can see parameters with equal or lower protecting level.

For example: When enter into 2nd level parameters screen, only parameters with Pr1 or Pr2 are displayed. And user can change a parameter's protecting level to Pr1 or Pr2 in this screen.

Use the **UP** and **DOWN** cursors to select the family of parameters and press **ENTER**.

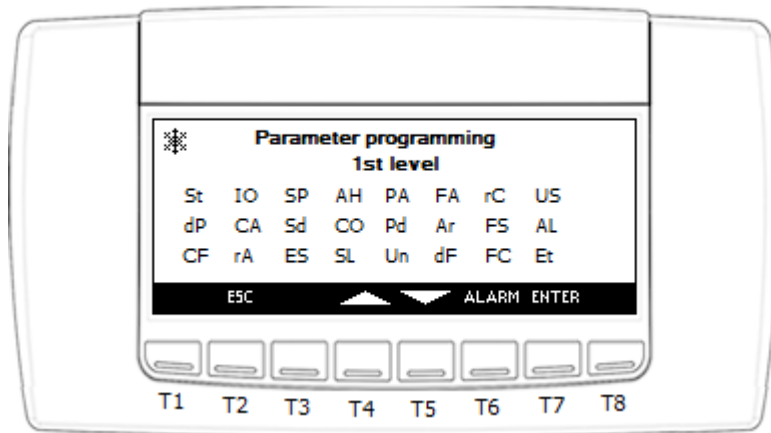

To modify a parameter, position the cursor on the value and use the **UP** and **DOWN** cursors and press **SET**:

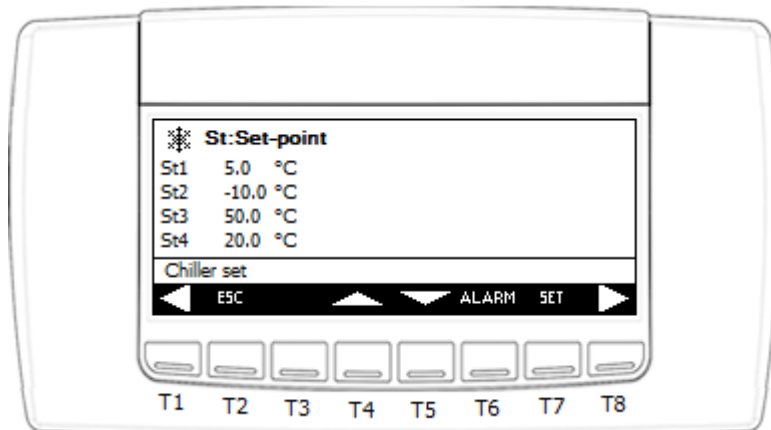

- The element starts to flash.
- Increase or decrease the value using the **UP** and **DOWN** keys.
- Confirm the modification by pressing the **SET** key again.

The cursor will automatically position itself on the next element, to modify it repeat the operation just described.

When cursor position in different parameters, the parameter's description will display in the bottom.

Press the **ESC** key several times to go back to the main screen.

Warning:

For parameter groups CF, IO, CA and RA, they can be verified and changed only if the unit is switch-OFF (stand-by).

5.9.2 Time/Time Bands

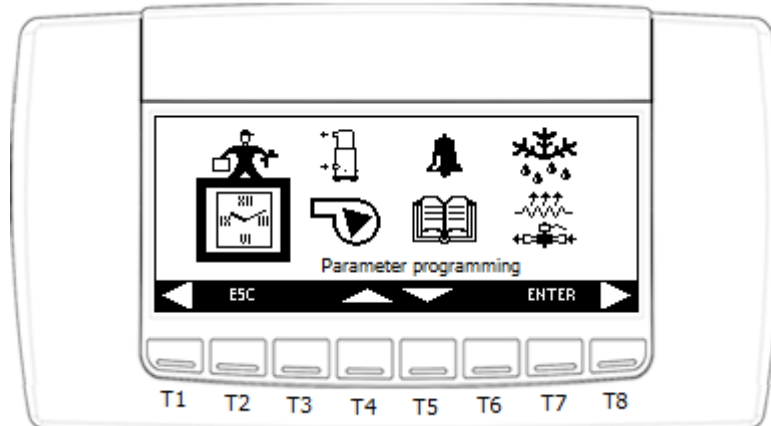

We have already seen previously that this menu is used for the time and date set. It is also possible to enable or disable the Energy Saving and/or automatic switch off of the time bands.

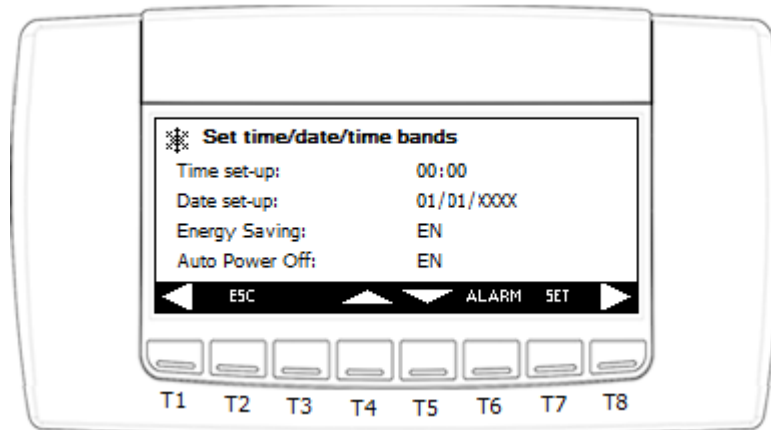

By pressing the  key, pass to the screen for the configuration of the three time bands.

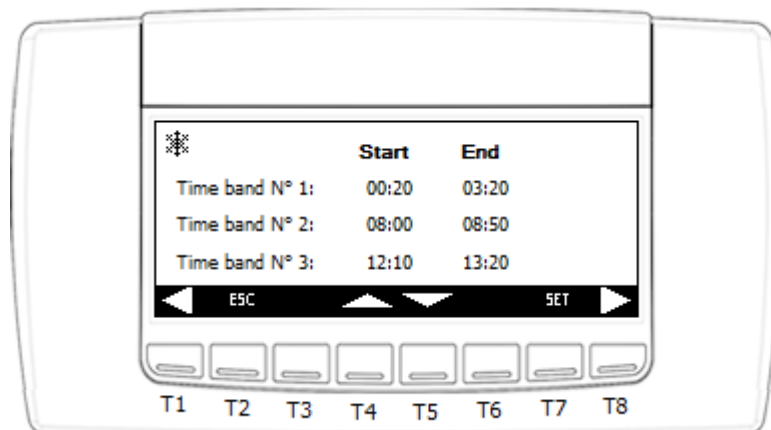

To modify the values, position the cursor on the element and press the **SET** key:

- The element starts to flash.
- Increase or decrease the value using the **UP** and **DOWN** keys.
- Confirm the modification by pressing the **SET** key again.

The cursor will automatically position itself on the next element, to modify it repeat the operation just described.

By pressing the  key again, pass to the screen for weekly programming of the time periods for the

Energy saving and for automatic switch-off.

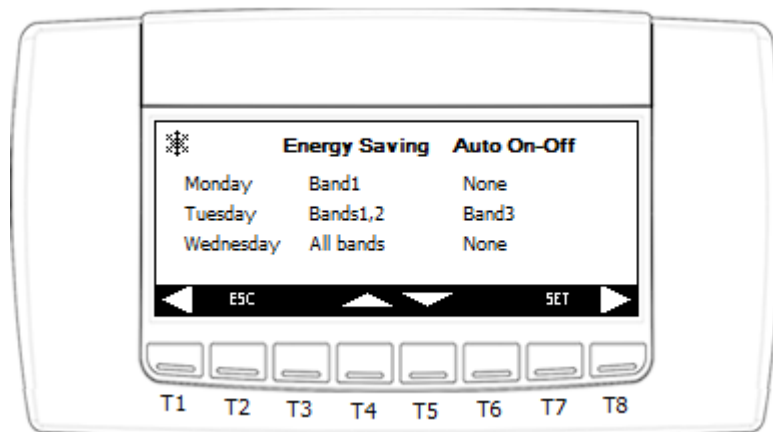

For every day of the week and for both functions, it is possible to manage:

- No time band
- Band 1
- Band 2
- Band 1 and 2
- Band 3
- Band 1 and 3
- Band 2 and 3
- All bands

Warning: Automatic switch-off has priority with respect to Energy saving
Press the **ESC** key several times to go back to the main screen.

5.9.3 Compressors

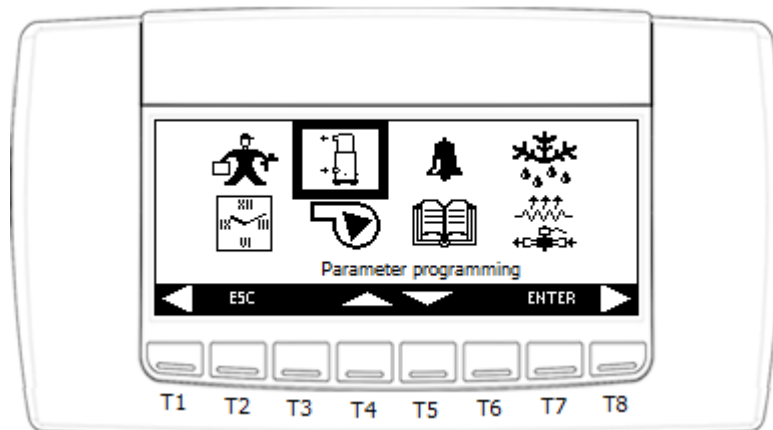

The following information is available for each circuit in this menu:

- Hours worked by each individual compressor
- Number of start-ups for each individual compressor

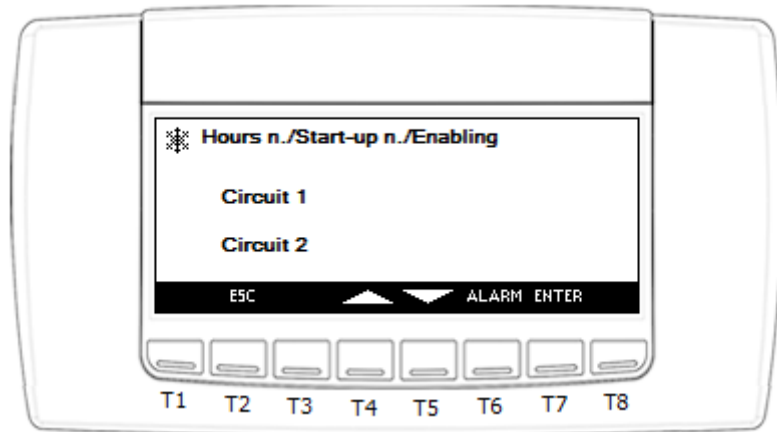

For each individual compressor it is possible:

- To reset the working hours
- Reset the number of start-ups
- Disable compressor working (e.g. perform maintenance)

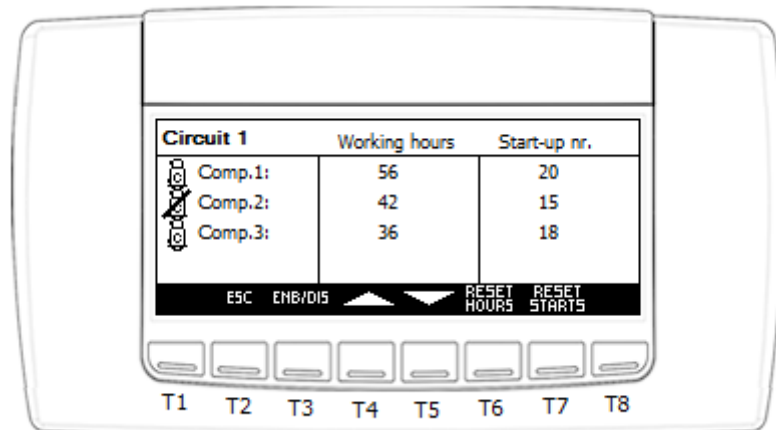

To reset the values, position the cursor on the element and press the **RESET HOURS** or **RESET STARTS** key:

The cursor will automatically position itself on the next element, to modify it repeat the operation just described.

To enable or disable a compressor, position the cursor on the element and press the **ENB/DIS** key:

The cursor will automatically position itself on the next element, to modify it repeat the operation just described.

5.9.4 Water Pump

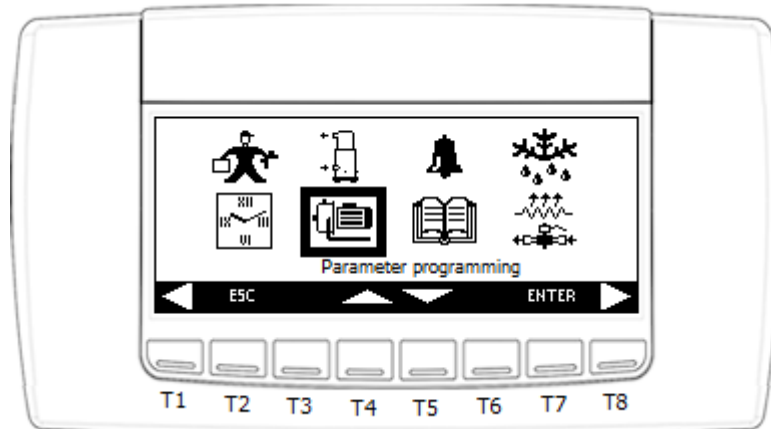

When CF01=0 (Air/air unit), instead of pump icon, the fan icon will display.

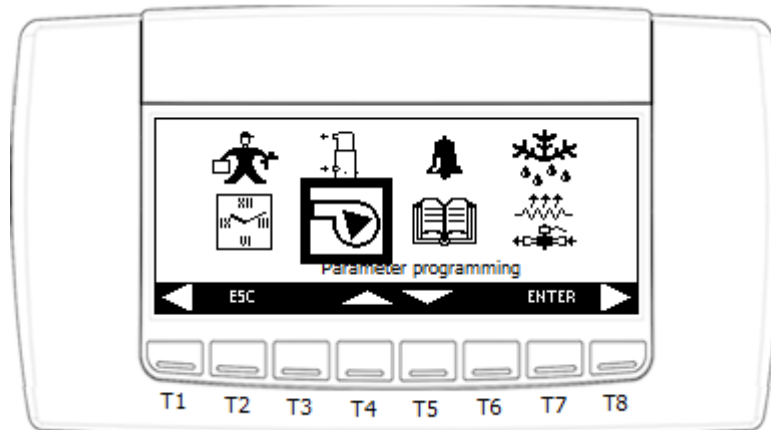

The following information is available in this menu:

- Hours worked by each individual pump (evaporator and condenser)

For each individual pump it is possible:

- To reset the working hours
- To disable the pump (e.g. perform maintenance)

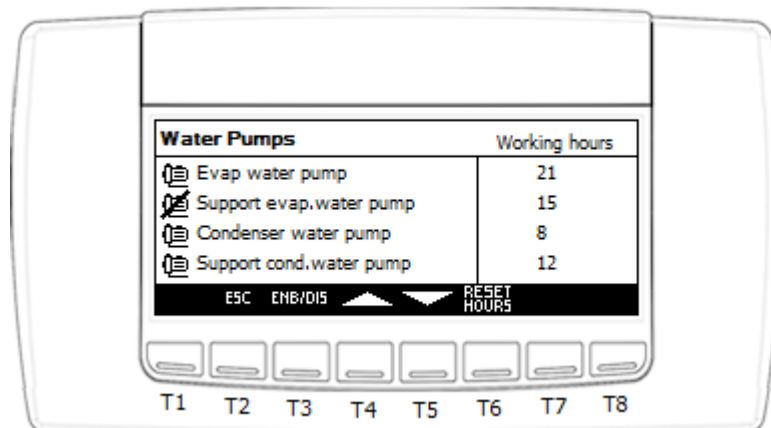

To reset working hours or disable/enable the pumps, follow the procedure described for the compressors.

5.9.5 Alarms Display

This menu contains the same information as press key ALARM in the main screen.

5.9.6 Historical Alarms

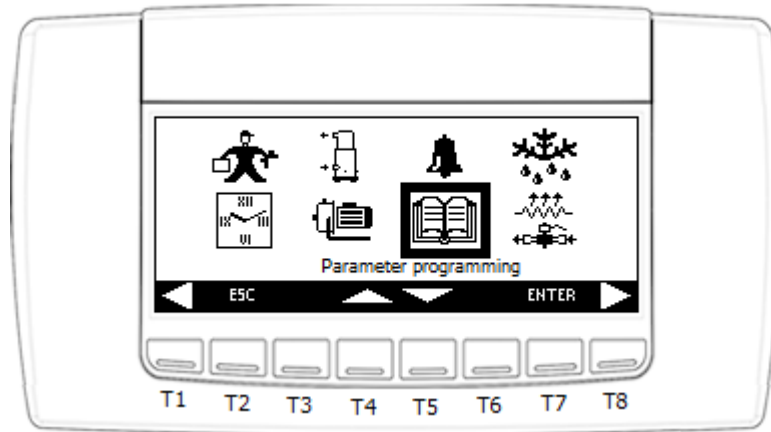

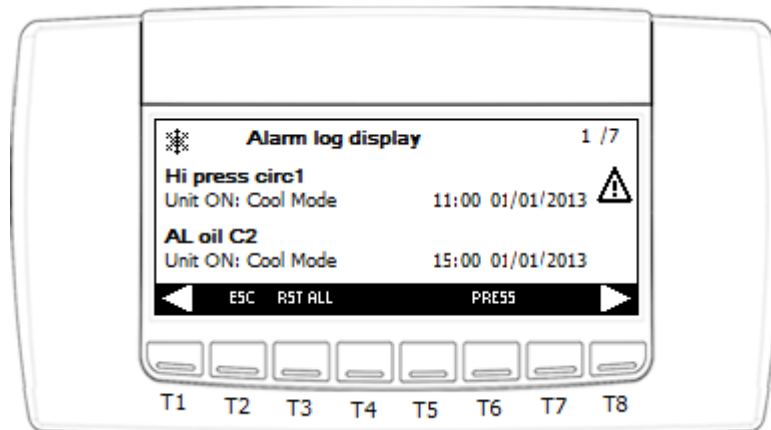

All alarms occurring are memorised in this screen.

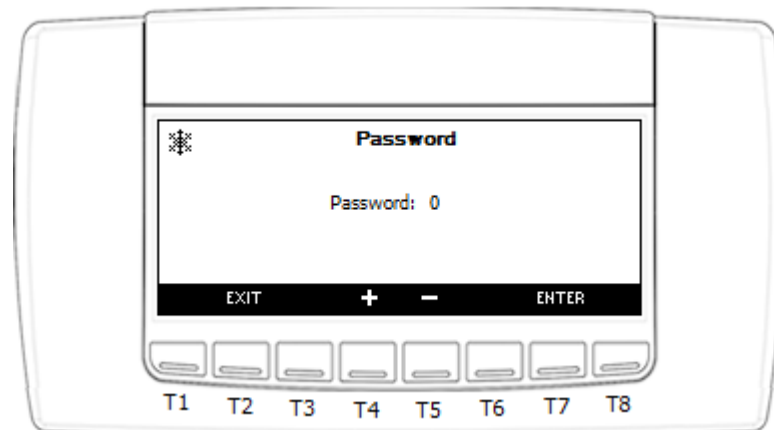

To reset the alarms log, operate as follows:

- Press the **RST ALL** key, holding it down for 3 seconds.



- Via keys  and , set the password.
- Press **ENTER** to confirm.
- If the password is correct, the following message will be displayed:

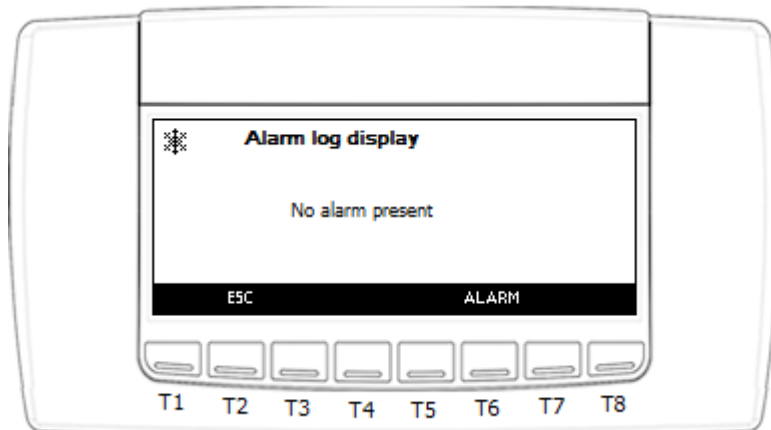
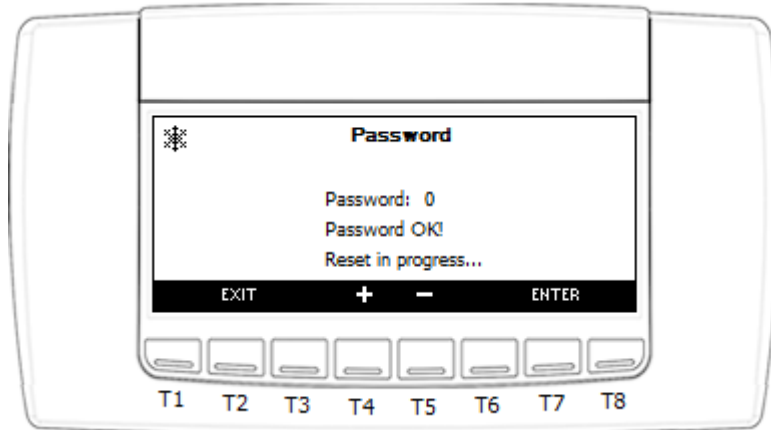

- If the password introduced is incorrect, the following message will be displayed:

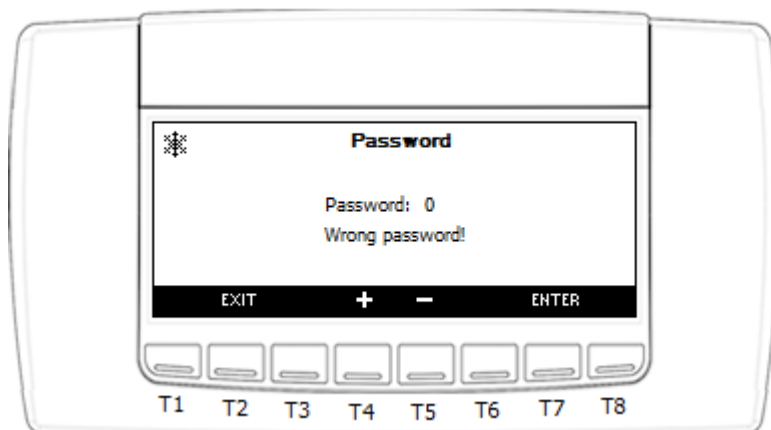

If the password is correct, after a few minutes you will go automatically back to the alarms screen.

5.9.7 Defrost

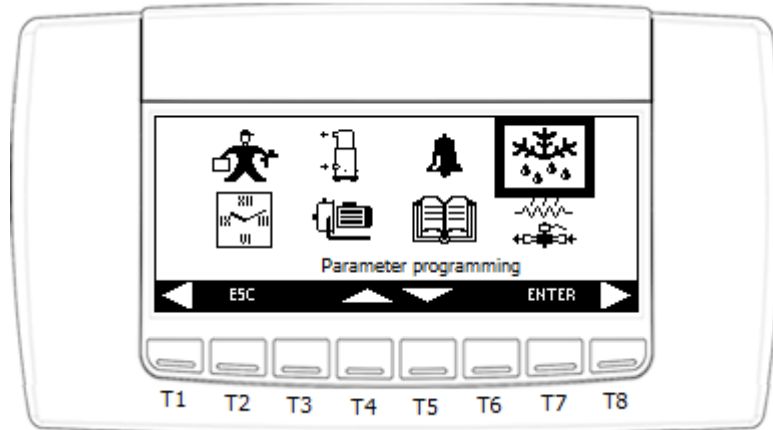

In this screen it is possible to check the status of the defrost cycle for every circuit present:

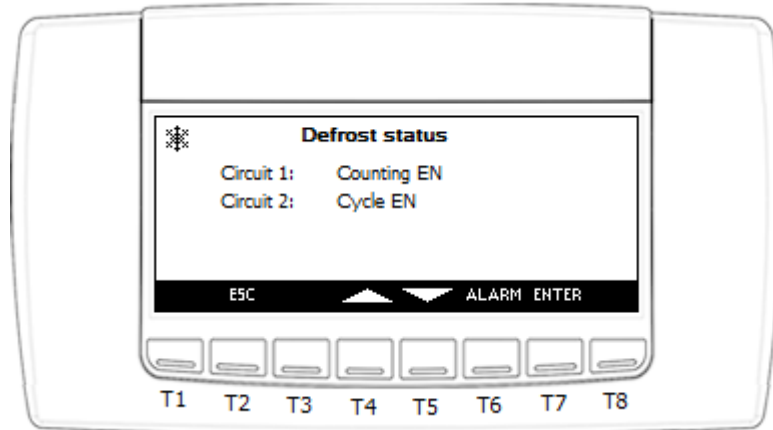

Circuit defrost status can be:

- Counting EN: In counting down, defrost will start soon
- Cycle EN: Defrost in progress
- Drip time EN: In dripping time
- Waiting: No defrost, normal working
- Condition not present: No necessary condition for defrost

By selecting the circuit affected and pressing **ENTER**, pass to the following screen.

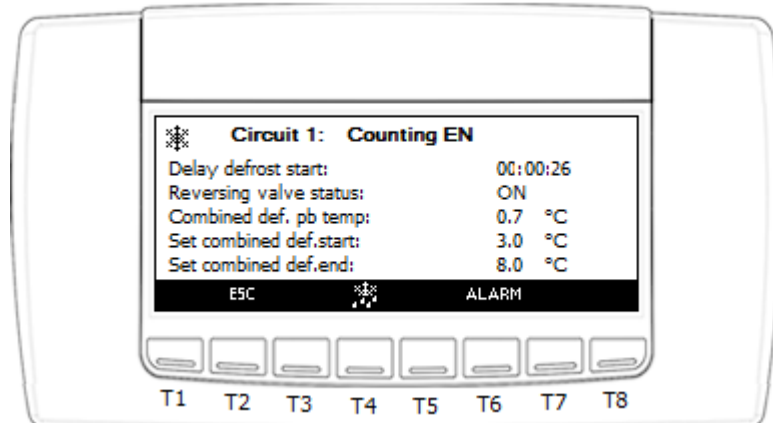

Press the  key for 5 seconds allows forcing start of the defrost cycle.

5.9.8 Heaters/Liquid Line Solenoid Valve

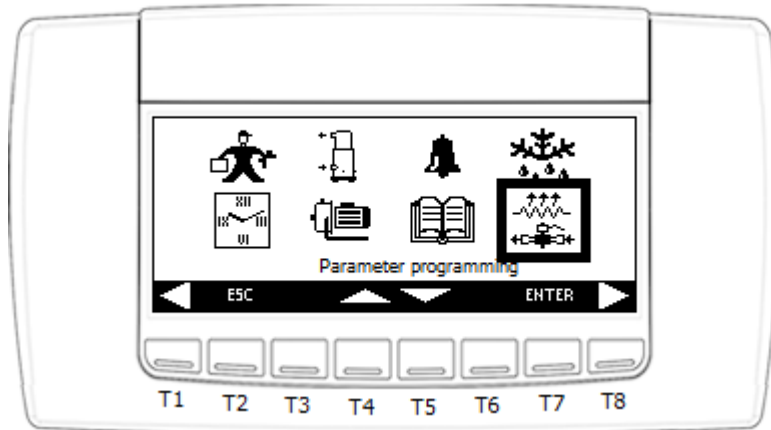

This menu allows to display the active and/or deactivated heaters and any active and/or deactivated liquid line solenoid valves (only the resources configured are displayed).

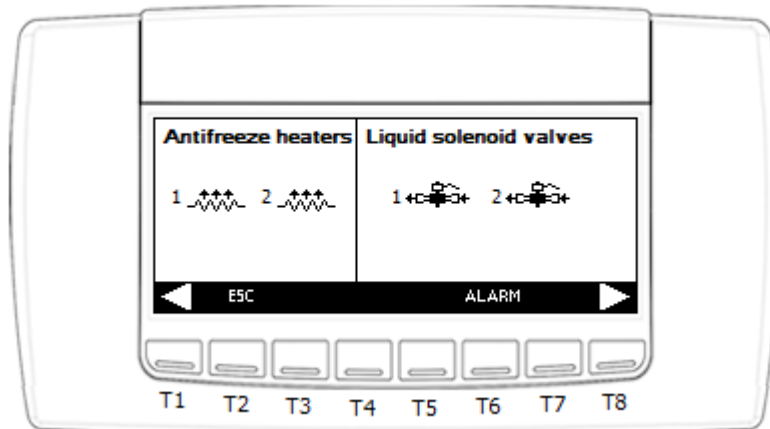

5.9.9 I/O Status

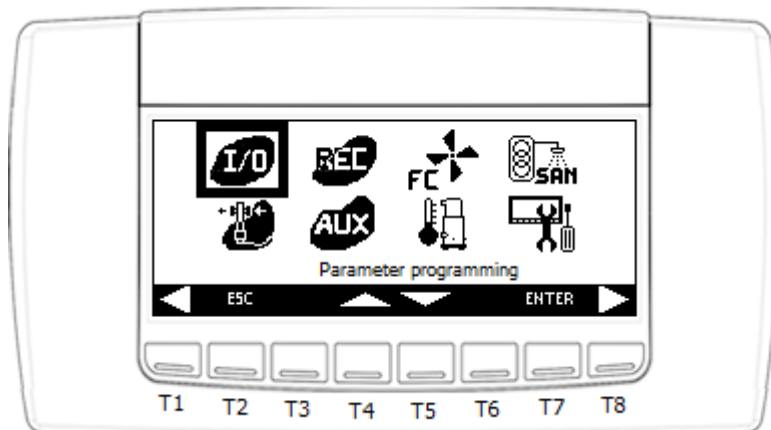

This menu allows to display the status of all inputs and outputs that have been defined.

The I/O units have been divided by groups, as in the screen below:

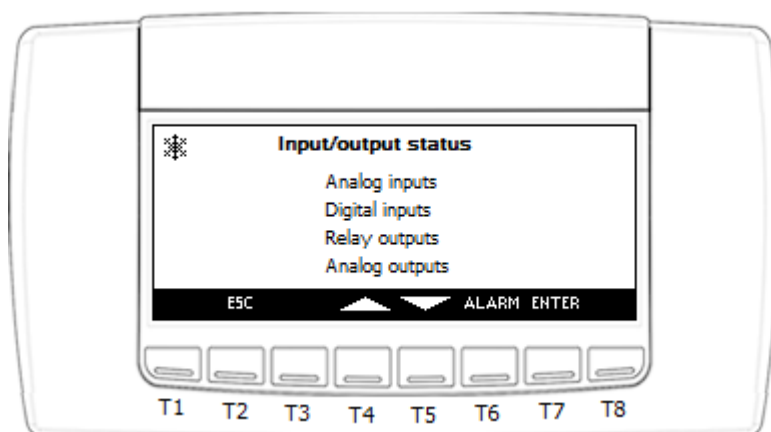

By pressing the **ENTER** key, it is possible to enter every I/O unit.

Analog inputs:

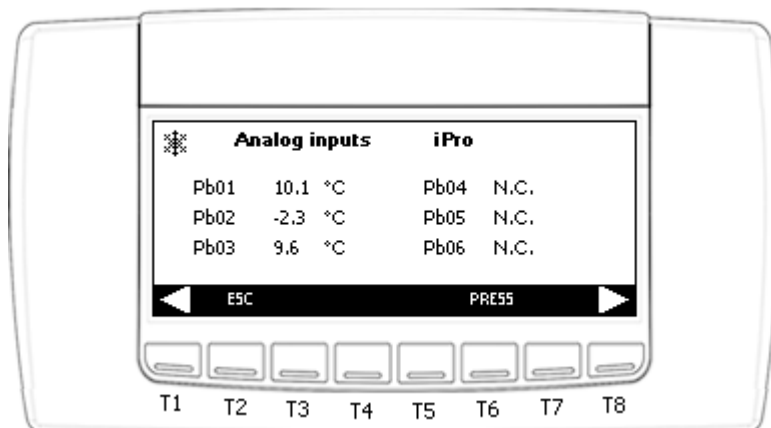

Digital inputs:

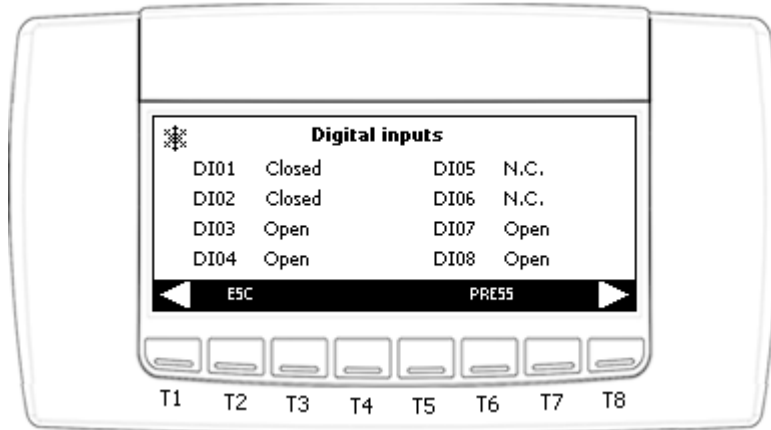

Relay outputs:

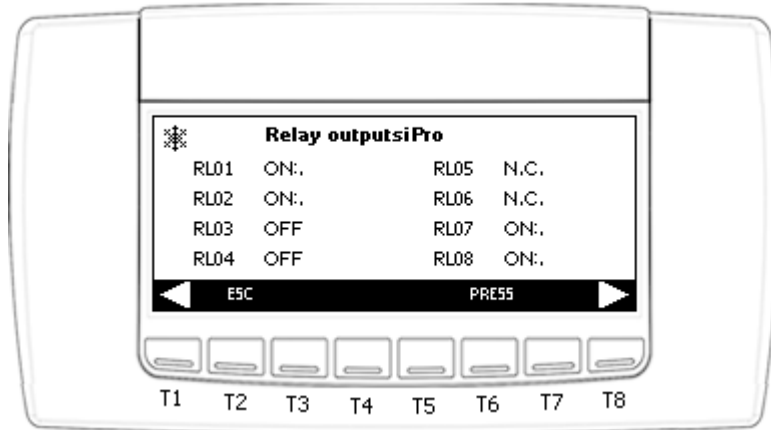

Analog outputs:

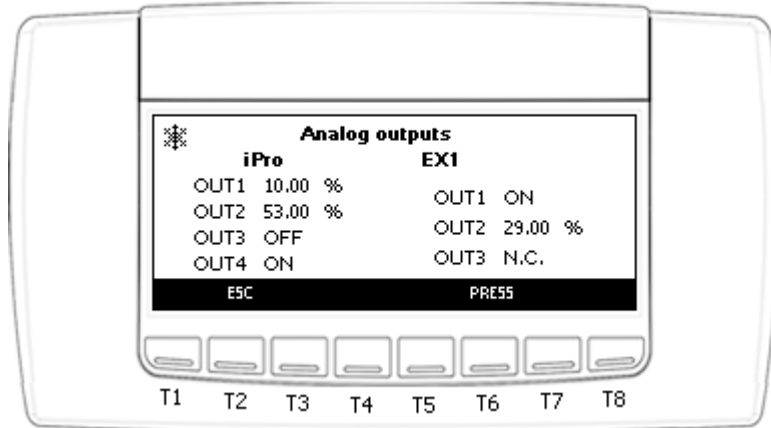

5.9.10 Thermostatic

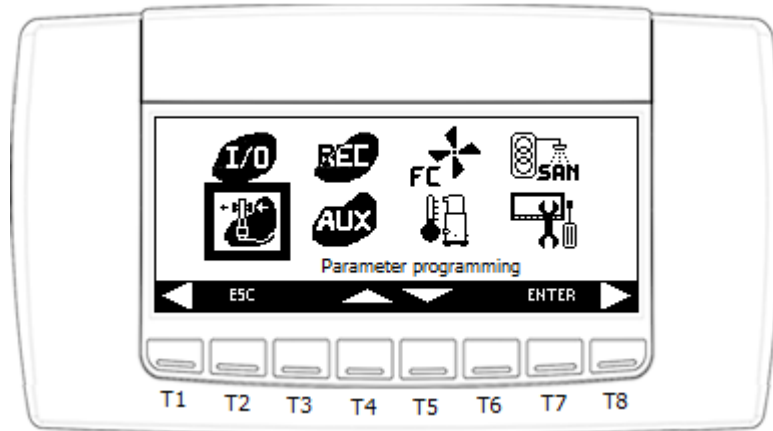

In this menu it is possible to check the working status of the valve and/or electronic thermostatic valves for every circuit defined.

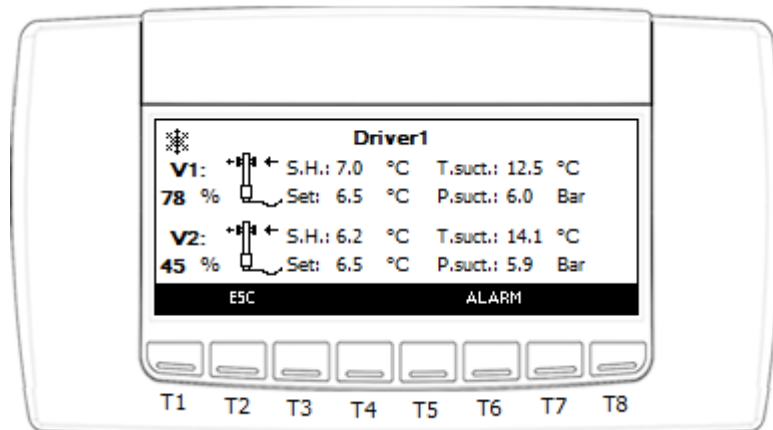
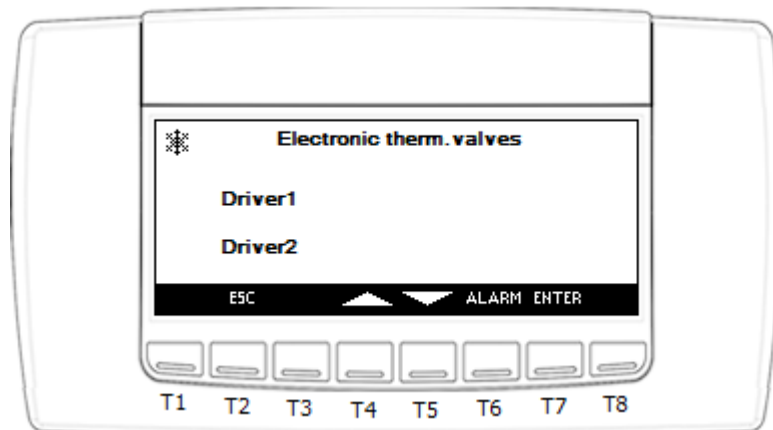

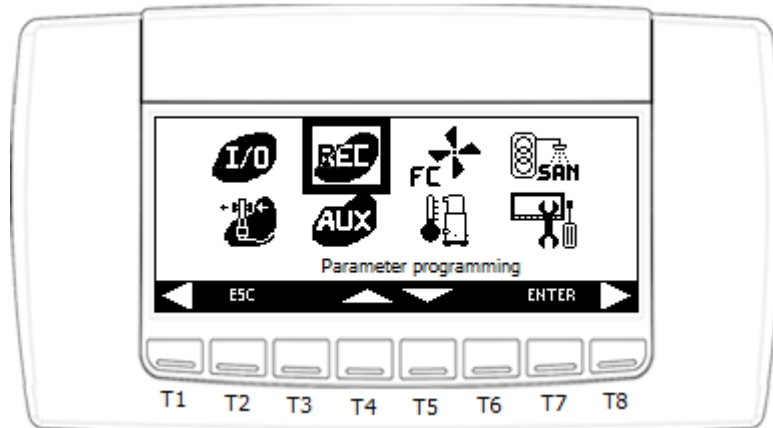

Press the **ESC** key to go back to the main screen.

5.9.11 Heat Recovery

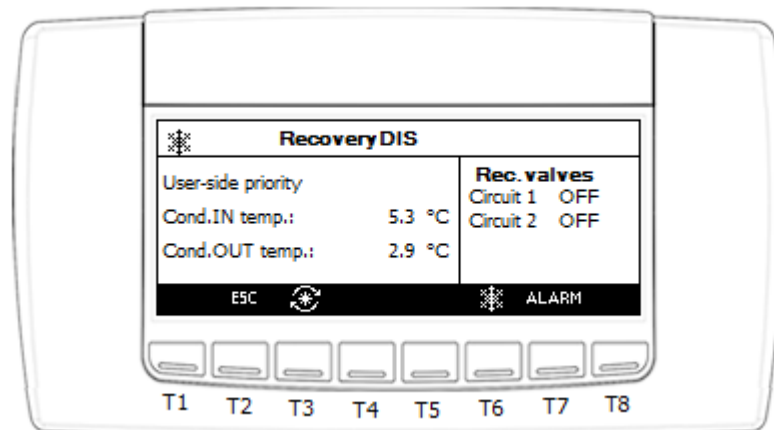

Using this menu it is possible to verify the recovery working status.



Press the  key for 1 second enables the recovery working.

The following information may be available in this screen:

- Status of the recovery function:
 - Disabled
 - Disabled from key
 - Enabled
 - Active
- Type of priority:
 - User side
 - Recovery side

Press the **ESC** key to go back to the main screen.

5.9.12 Auxiliary Outputs

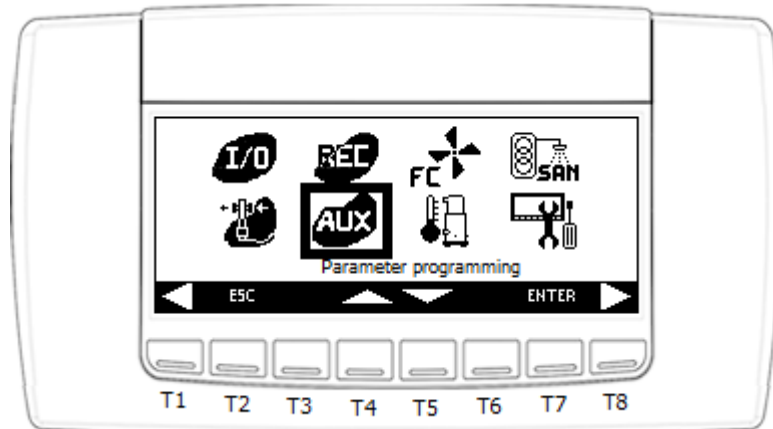

Using this menu it is possible to display the status of the auxiliary outputs (if present).

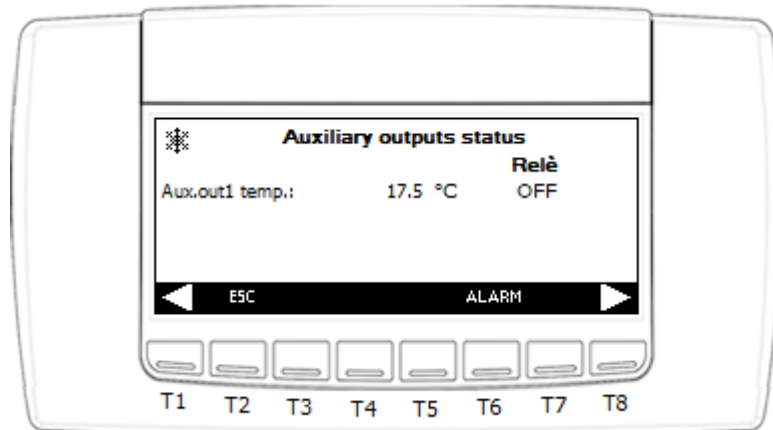

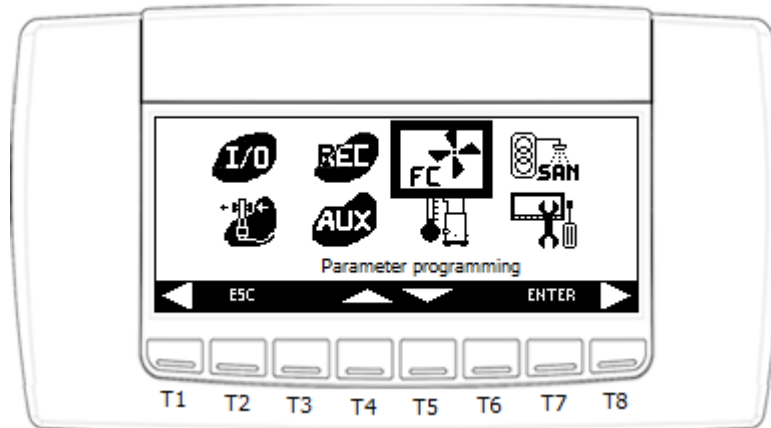

Press the **ESC** key to go back to the main screen.

5.9.13 Free-Cooling

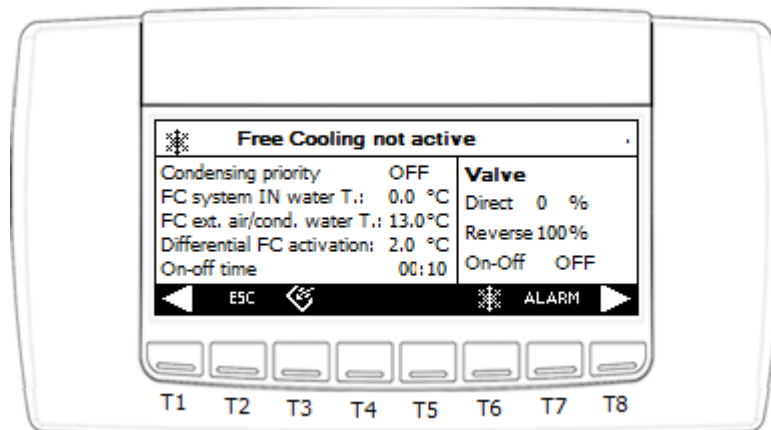

Using this menu it is possible to verify the free cooling working status.
If $FC01 \neq 4$, this following screen will display:



Press the  key for 1 second can enable the free cooling working.



The following information may be available in this screen:

- Status of the free cooling function:
 - Not active
 - Disabled from key
 - Disabled from anti-freeze
 - OFF
 - ON
- Type of priority:
 - Condensation
 - Free-cooling
 - External ventilation

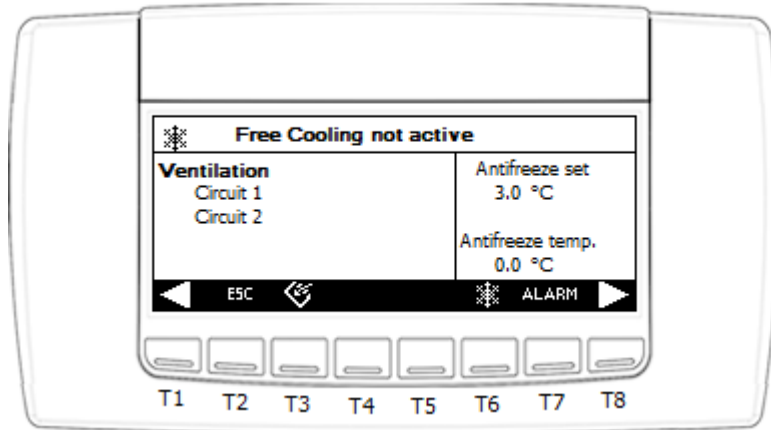
By pressing the  key, pass to the next screen where the following information is available (only if $CF01 \neq 0$):



Press the **ESC** key to go back to the main screen.

If FC01 = 4, the following 3 screens will display. Press key  and  can switch between screens:

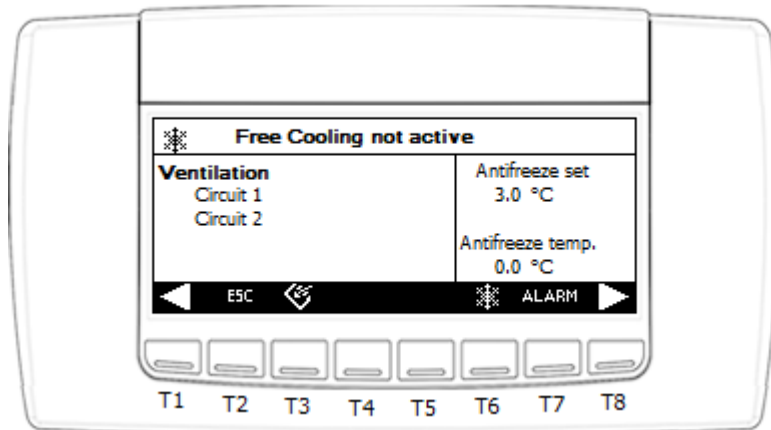
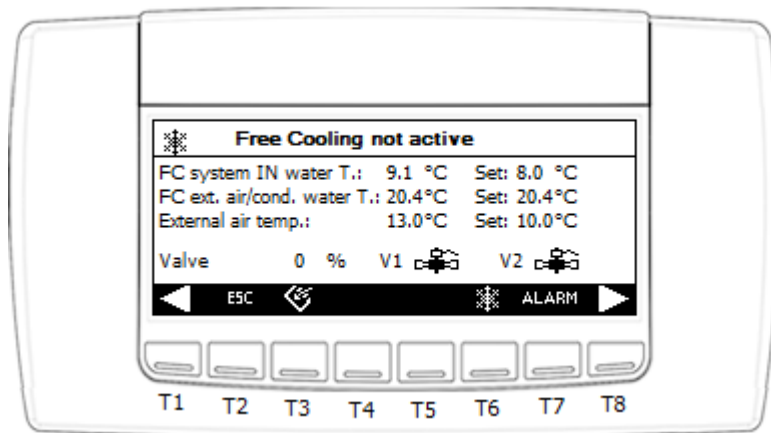

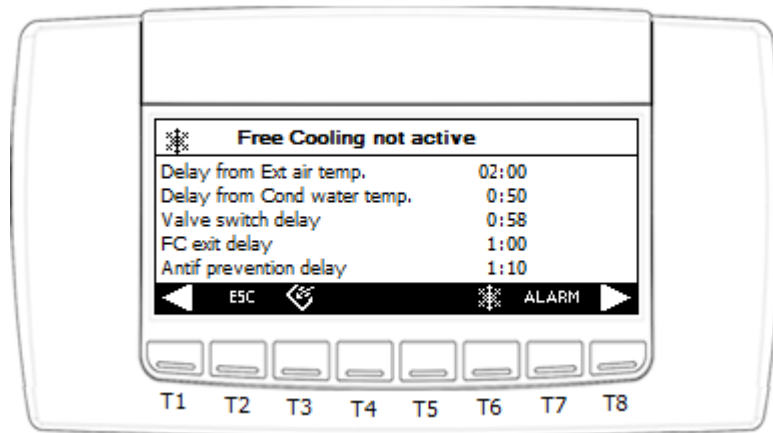

Delay in free-cooling:

- Delay from Ext. air temp.: Count down from parameter FC03
- Delay from Cond water temp.: Count down from parameter FC19
- Valve switch delay: Count down from parameter FC20
- FC exit delay: Count down from parameter FC23
- Antif prevention delay: Count down from parameter FC24

Press the **ESC** key to go back to the main screen.

5.9.14 Screw Compressor

If CO09 = 2/3, screw compressor is used. The icon is shown as picture below.

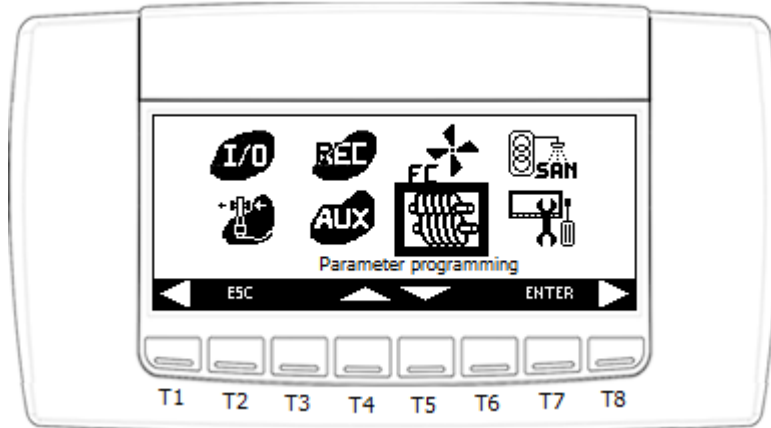

This menu can be used to monitor the working status of the screw compressor in the various circuits.

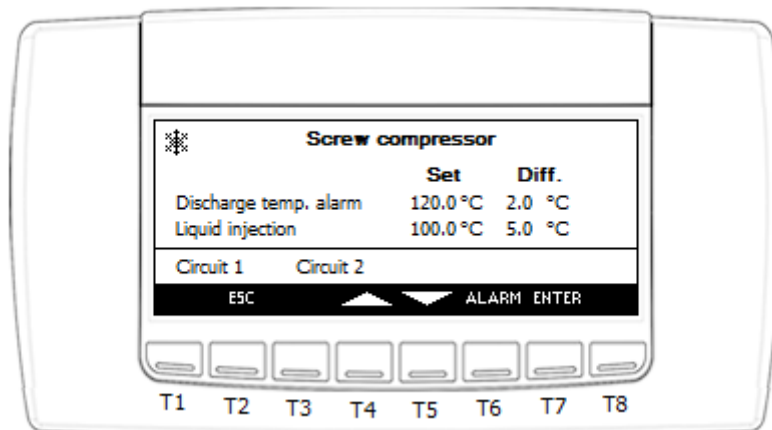

By selecting the desired circuit and pressing **ENTER**, the following information can be displayed:

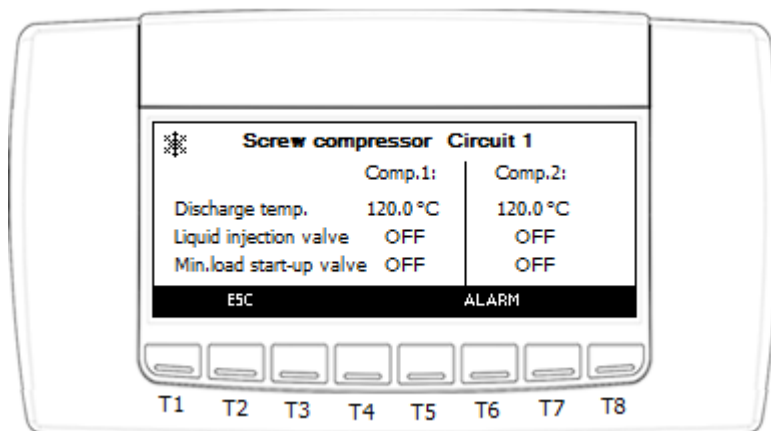

5.9.15 Discharge Compressor Temperature

If CO09 = 0/1, discharge compressor icon is shown as picture below.

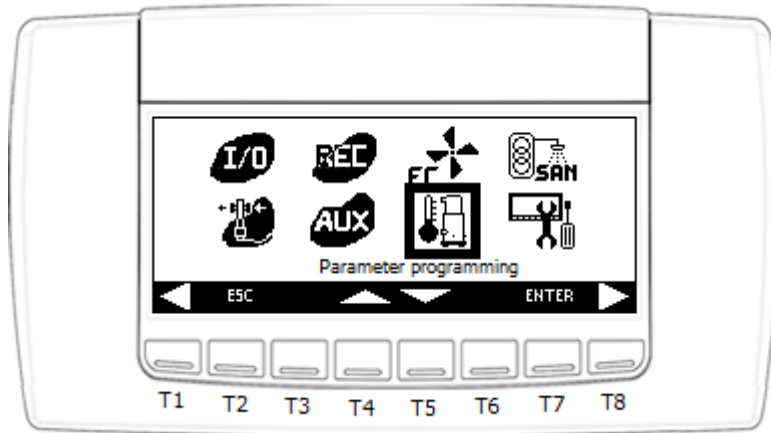

In this screen, if the probe: **compressor 1..6 PTC supply temperature probe** (AI type=1 to 16) is configured, its value will be displayed.

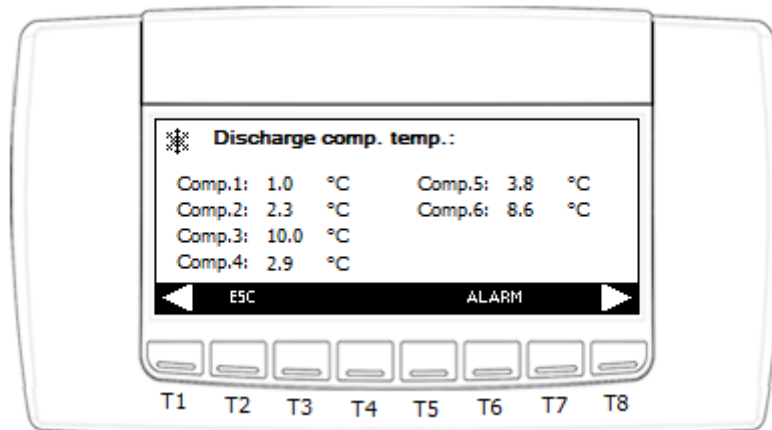

5.9.16 Domestic Hot Water (Sanitary Water)

If AH01 = 0 (Auxiliary heating is disabled), the icon for domestic hot water is shown as picture below.

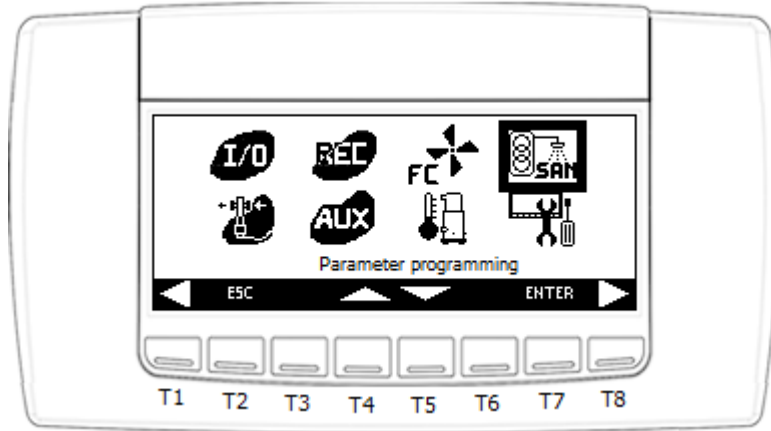

In sanitary water screen, relevant probes value and output status will display. The sanitary water set point is editable.

Press key  for 1 second can enable/disable the sanitary water function.

The sanitary water function status can be:

- DIS disabled by parameter setting
- Dis by key disabled by keyboard
- Not requested not needed
- Doing dF defrost in progress
- Changing state requested but not start yet, in inversion valve changing phase.
- ON activated

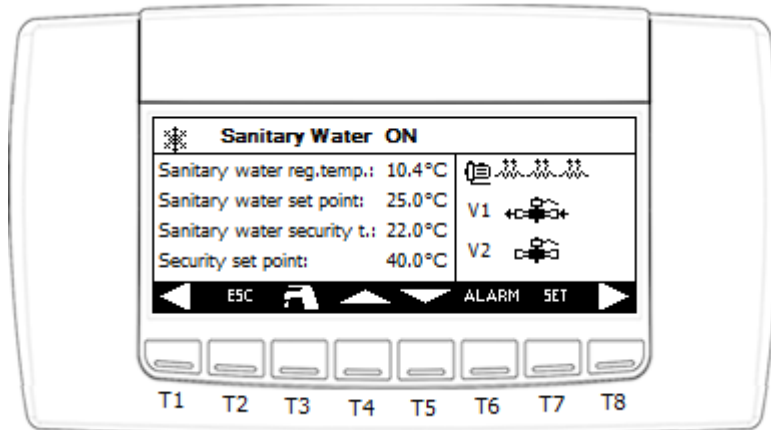

In Anti-legionella cycle screen, relevant probes value, status and count down time will display. The Anti-legionella set point and the activate time is editable.

The Anti-legionella function status can be:

- DIS disabled by parameter setting
- Not active deactive
- Running active

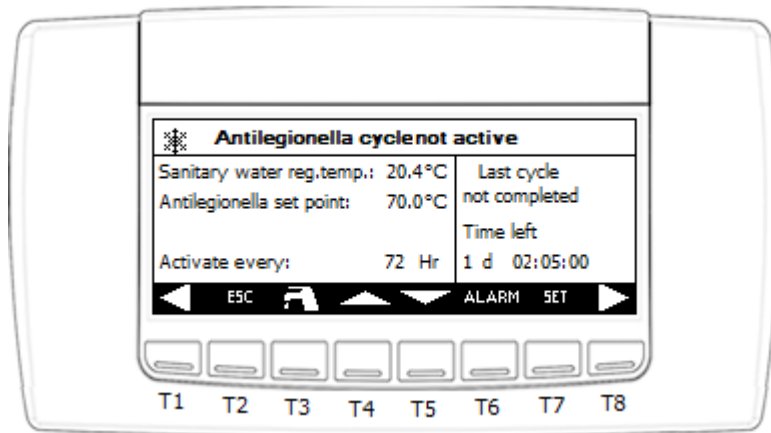

In Solar panel screen, relevant probes value and output status will display.
 The Solar panel set point is editable.
 The solar panel working status can be:

- Not active
- Active

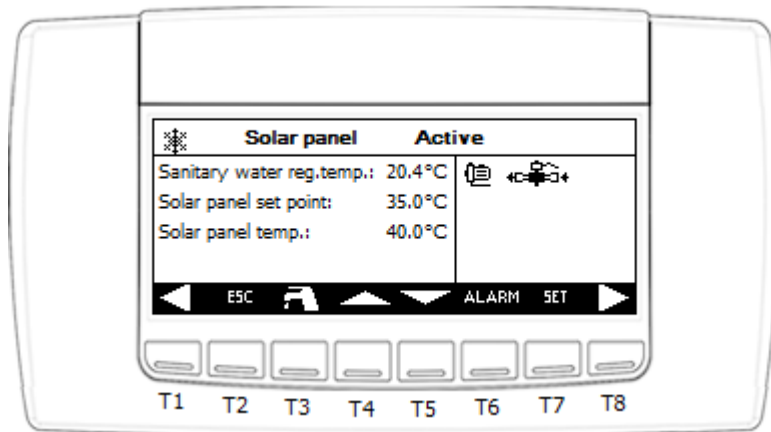

5.9.17 Auxiliary Heating

If AH01 > 0 (Auxiliary heating is enabled), the icon for auxiliary heating is shown as picture below.

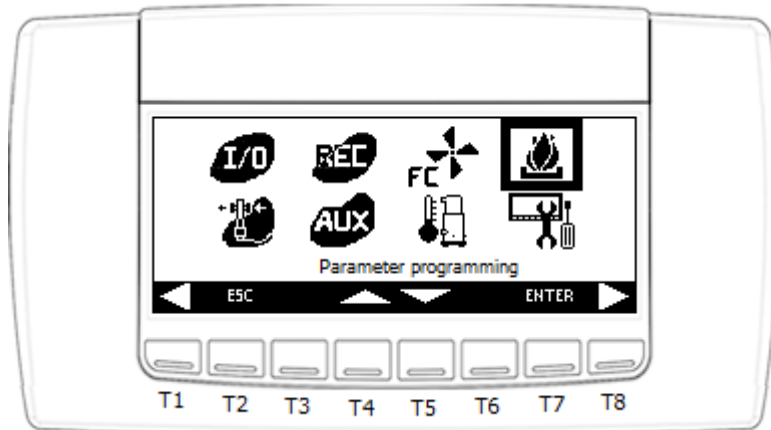

In auxiliary heating screen, set points and output status are displayed.

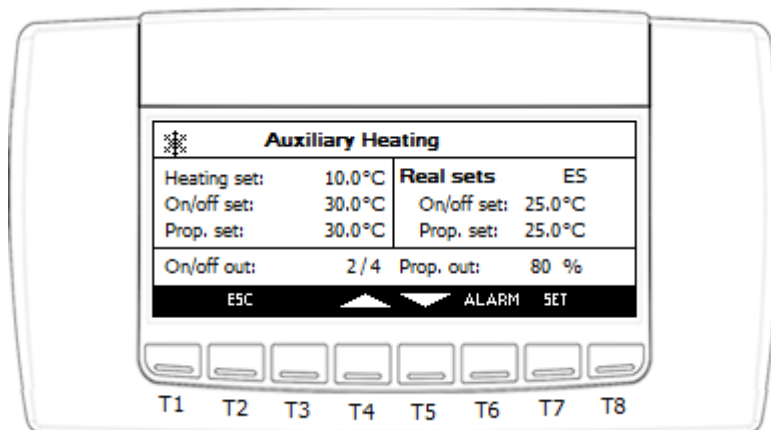

5.9.18 Control Panel

Your own LCD keyboard can be customised in this menu.

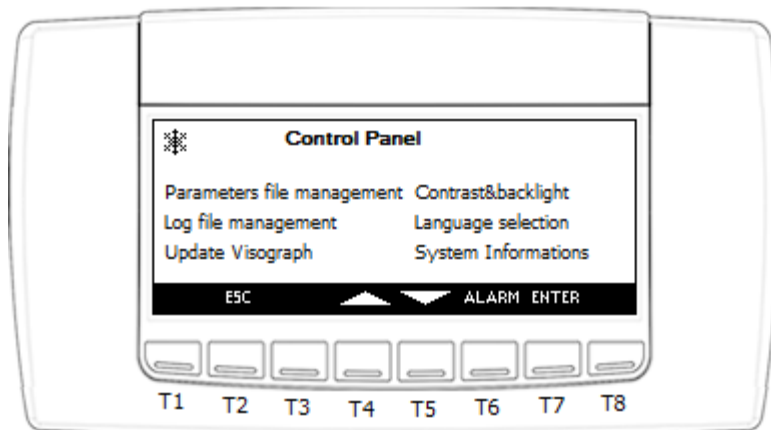

If user entered into SERVICE menu with 1st level or 2nd level, he needs to input the 3rd level password to

enter in the control panel screen. See graph below:

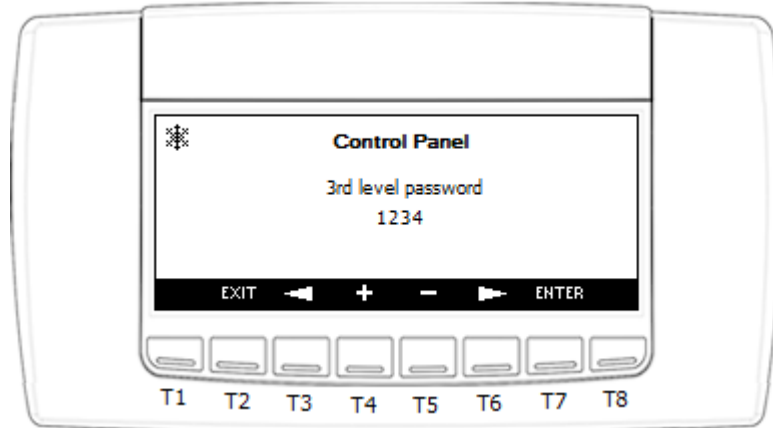

On the contrary, if user entered into SERVICE menu with 3rd level, no password is needed for control panel menu anymore.

The possible options in this menu are:

- Parameters file management: Load last saved parameters or load default parameters.
 - Contrast & backlight:
 - Contrast: regulation from 0 to 200
 - Back light time ON: regulation from 0 to 200 seconds, or always on
 - Log file management:
 - Export log files to USB disk.
 - Language selection: Italian → English → Italian
 - Update Visograph
 - System Informations: Release software, setting IP address and ModBus node.
-
- Parameters file management:

Position the cursor on the element with UP and DOWN key, press ENTER, the parameters value will be loaded from configuration file.

There are 2 files available, one for latest saved parameters and another for default parameters.

The 3rd line "Save as default parameters" means copy latest saved parameters to default parameters configuration file.

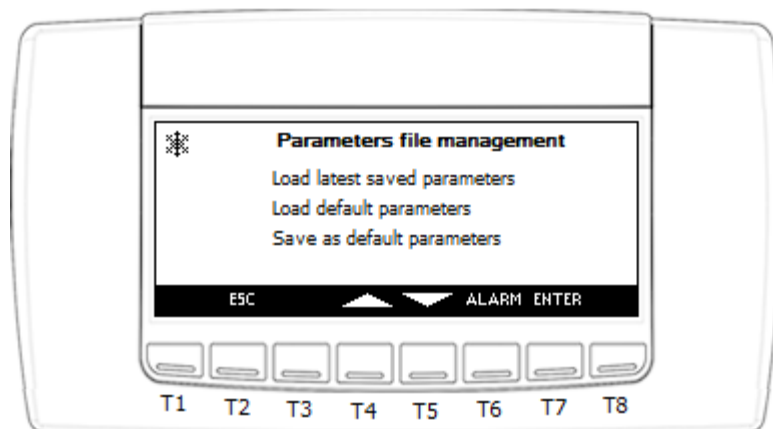

- Log file management:

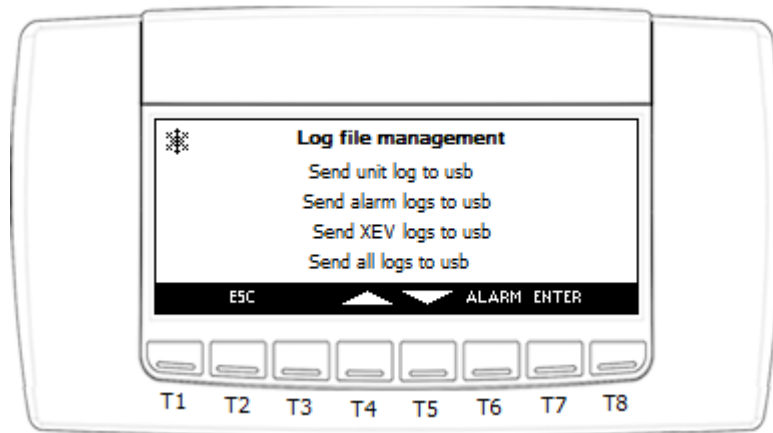

Plug the USB disk in iPro, send command from this screen, the log file will be exported to the USB disk.

The log file path is: USB ROOT:\ipro\IP address of the ipro

One example for unit log: F:\ipro\10.161.92.79\log\Unit_20130221.txt

Unit log file (Record every 100 PLC cycles):

```

1 Counter,Date,Status,Set,Regulation probe,steps required,steps provided,unloading,water pumps,average cycle time,overcycles
2 130117101213,HP,100,-61,3,3,FALSE,FALSE,99,42,
3 130117101226,HP,100,-61,3,3,FALSE,FALSE,100,37,
4 130117101238,HP,100,-61,3,3,FALSE,FALSE,94,38,
5 130117101251,HP,100,-61,3,3,FALSE,FALSE,94,36,

```

Alarms log file (including alarms_a, alarms_b, alarms_c):

- alarms_a = unit alarm
- alarms_b = circuit alarm
- alarms_c = compressor alarm

alarms_a log file:

```

1 Counter,Date,Alarm description,Alarm status,Events in last hour
2 121115150206,AEM3-IPEX 3 not connected,START,18
3 121115150206,AEM4-IPEX 4 not connected,START,18
4 121115150307,AP22-Failure on probe 5 exp. 2,START,19
5 121115150307,AP5 -Failure on probe 5,START,19

```

Xev log file (including xev11, xev12, xev21, xev22):

Record every 10 seconds if XEV20D is available.

```

1 Counter,Date,Suction pressure,Saturation temperature,Suction temperature,Superheating,Steps
2 130130121005,60,45,125,70,500
3 130130121015,59,44,121,68,496
4 130130121025,57,45,123,63,492
5 130130121035,56,44,122,61,488

```

- Language selection:

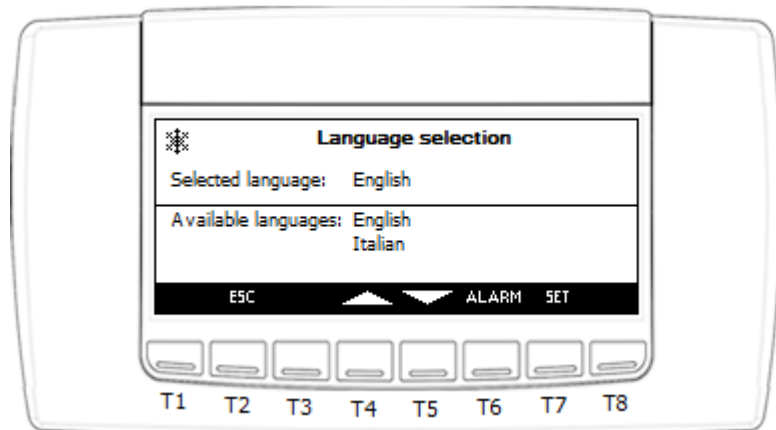

Use key UP and DOWN to select the language. If new language is selected, the warning will show as below. Press key SET to start language update. Please don't switch off the iPro during updating.

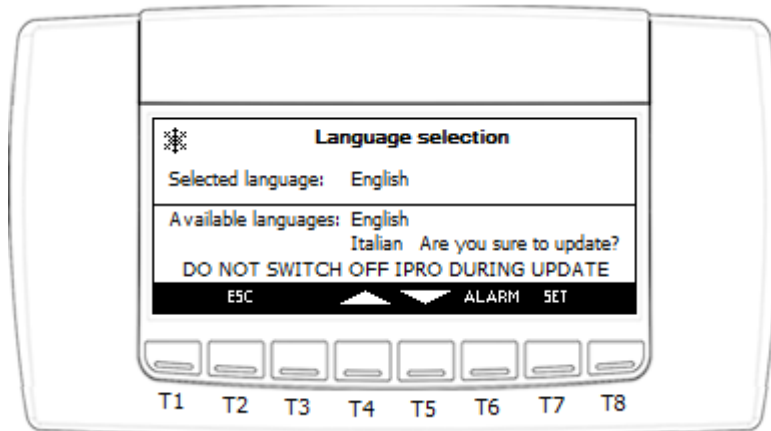

- Update Visograph:
Press key ENTER, Visograph application will be updated. If the unit is ON now, the updating is not allowed.

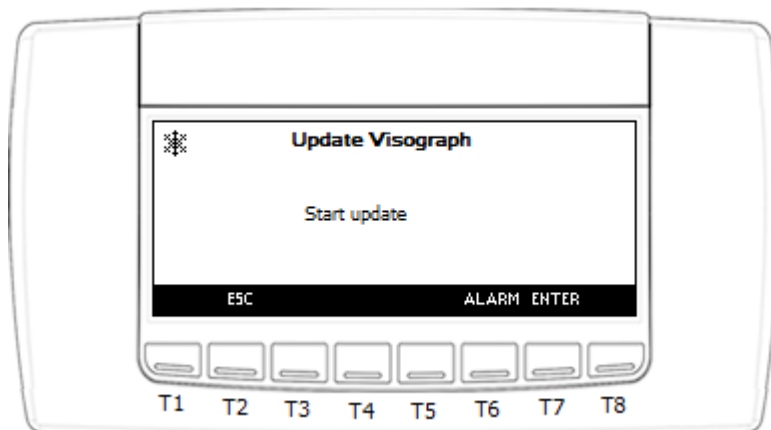

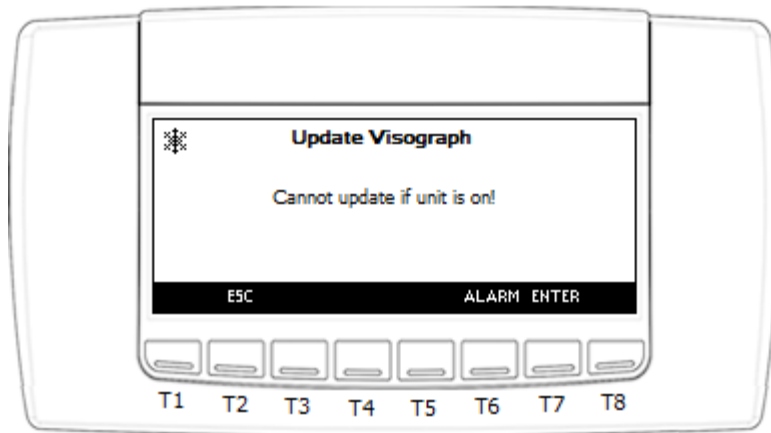

- System informations:

The IP address and ModBUS address are editable, but the modification will be actual at next reboot of the iPro.

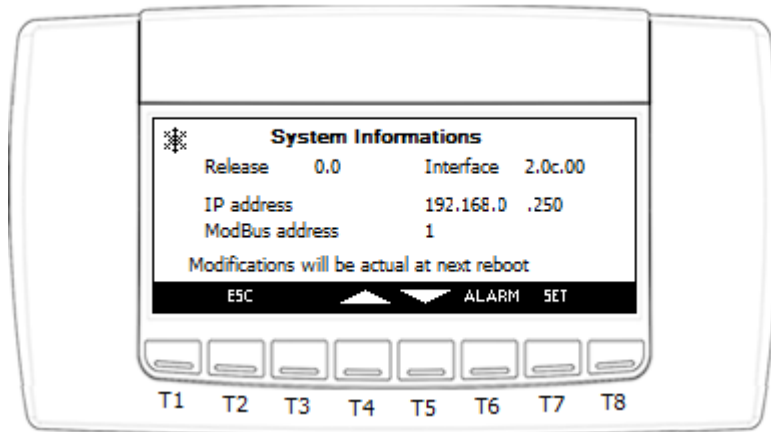

6. USER INTERFACE VISOTOUCH

Configure parameter DP12=2 from Wizmate can select VISOTOUCH as the user interface.

VISOTOUCH shows similar screens as VISOGRAPH 1.0, and it manages two LEDs on the front panel in addition.

- Green LED: Always ON after power on.
- Red LED: ON when have alarm active or resettable.

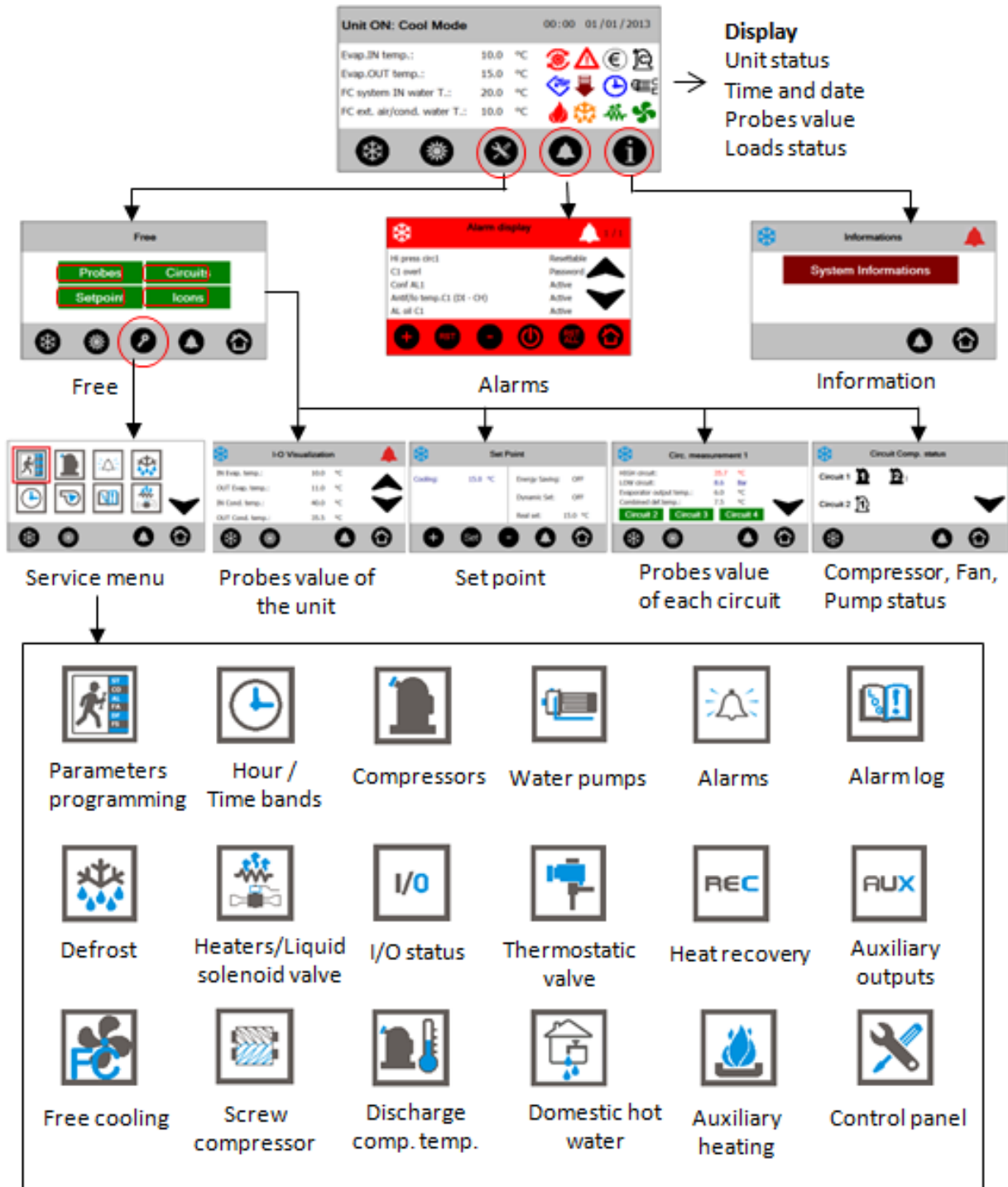

The information that appears in the main screen is:

Unit ON: Cool Mode		00:00	01/01/2013
Evap.IN temp.:	10.0 °C		
Evap.OUT temp.:	15.0 °C		
FC system IN water T.:	20.0 °C		
FC ext. air/cond. water T.:	10.0 °C		

Additional icons shown in the bottom row of the screen:

-
-
-
-
-





- to indicate that at least one of the compressors is working.
- to indicate that the evaporator pump **E** and/or the condenser pump **C** are working (the condenser pumps are present in the case of WATER-WATER configuration).
- to indicate that the condenser fans are working (in the case of AIR-AIR or AIR-WATER unit configuration)

If the alarms occur or particular working modes sub-enter, the following icons will be shown on the main screens:

- flashing to indicate that an alarm is active
- to indicate that the UNLOADING mode is in progress
- on to indicate that the defrost cycle is in progress, flashing during the count down
- to indicate that the anti-freeze/support heaters are active
- automatic switch-off and/or energy saving is enabled during the current day
- to indicate that the unit is working within the energy saving period or that the dynamic set-point is active
- to indicate that the domestic hot water production is active

-  to indicate that the auxiliary heating is active (it will display in the same place with domestic hot water production icon)







After iPro power-on, the main screen will be the following (Displayed probes are selectable by DP parameters):

Unit in Stand-by		09:00 01/01/2013
Evap.IN temp.:	11.0 °C	
Evap.OUT temp.:	12.0 °C	
FC system IN water T.:	13.0 °C	
FC ext. air/cond. water T.:	10.0 °C	
    		

When the keyboard shows “Remote OFF”, “OFF through clock” or “Stand-by”, they all mean the unit is OFF now but with different causes.

When the keyboard shows “Unit ON: Cool Mode” or “Unit ON: Heat Mode”, they all mean the unit is ON now but in different working mode.

Below find a typical screen during working in chiller mode:

Unit ON: Cool Mode		09:00 01/01/2013
Evap.IN temp.:	11.0 °C	
Evap.OUT temp.:	12.0 °C	
FC system IN water T.:	13.0 °C	
FC ext. air/cond. water T.:	10.0 °C	
   		

6.1 HOW TO SWITCH ON/OFF THE UNIT AND CHANGE CHILLER/HEAT PUMP WORK MODE FROM VISOTOUCH

Firstly, we will talk about No Motor Condensing Unit. Set Par **CF04** = 0.

UNIT SWITCH-ON AND SWITCH-OFF CAN TAKE PLACE:

- From the keyboard
- From digital input configured as remote ON/OFF
- By time bands (see unit switch on/off by RTC)

6.1.1 Unit Switch-ON/OFF From The Visotouch

The unit can be configured as chiller only, heat pump only or as chiller with heat pump mode by par CF02. For different type of units, the switch ON/OFF procedures are different.

CF 2	Selection of unit working 1 = chiller only 2 = heat pump only 3 = chiller with heat pump	1	3		
-------------	---	---	---	--	--

Note: If user wants change CF02 value, please switch off the unit to "Stand-by" status first. Otherwise, it may take no effect.

When only the heating is enabled, the ACF1 alarm is not generated if the reverse valves in the envisioned circuits are not configured.



SWITCH THE UNIT ON/OFF IN COOLING- HEATING MODE FROM THE VISOTOUCH



The configuration should be:



CF04 = 0, (not Motor condensing unit)

CF02 = 3, (chiller with heat pump)



SP09 = 0, (from the keyboard)

In the beginning, the device is in stand-by mode, and the buttons  and  are all visible. These two buttons' position depends on Par SP08.

SP08 = 0:  is placed in left,  is placed in right.

SP08 = 1:  is placed in left,  is placed in right.

No matter how to place, the left button is always used for cooling mode. The right button is always used for heating mode.

Suppose SP08 = 0, press button  for 1 second can switch on the unit to work in cooling mode. At this moment  is hidden.

Press the button  again, the unit is switch OFF and return to status stand-by. The button  and  are all visible now. In this case, user can press button  to switch to heating mode or press  to restart the cooling mode.

The device is in stand-by when both  and  buttons are visible. The stand-by mode is obtained every time that the unit is off from cooling or heating working mode. Also in stand-by mode, the controller gives the possibility to:

- display the variables detected
- manage the alarm situations, displaying and signalling them.

When unit is ON in chiller mode, the status in the screen is "Cool Mode":

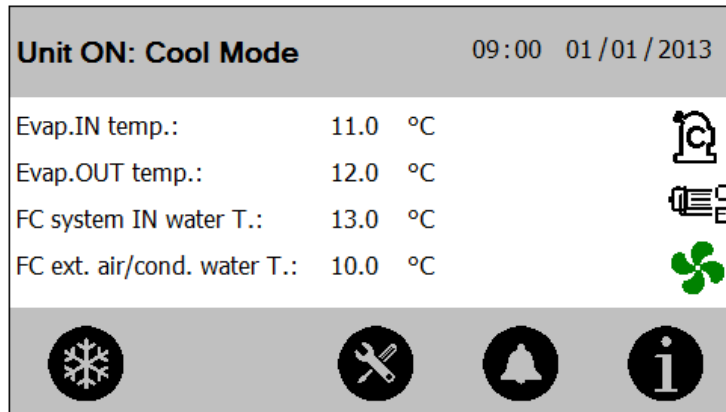

When unit is ON in heat pump mode, the status in the screen is “Heat Mode”:

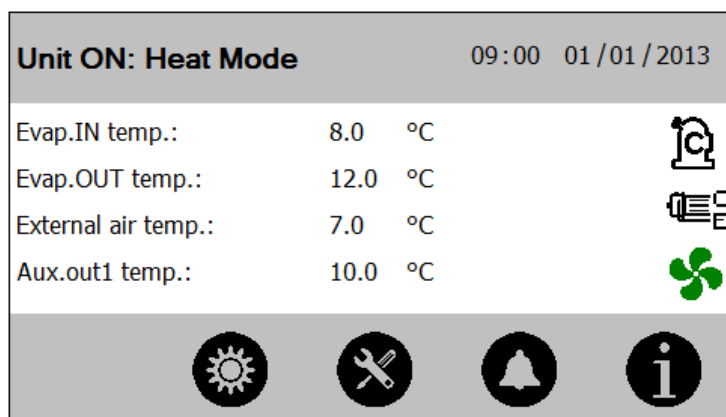



SWITCH THE UNIT ON/OFF IN COOLING MODE FROM THE VISOTOUCH

The configuration should be:

CF04 = 0, (not Motor condensing unit)

CF02 = 1, (chiller only)

SP09 = 0, (from the keyboard)

In the Visotouch, the left button is always visible and the right button is hidden. The left button will be shown as  when SP08 = 0 and shown as  when SP08 = 1.

Press this button for 1 second can switch the device status between cooling mode and stand-by.



SWITCH THE UNIT ON/OFF IN HEATING MODE FROM THE VISOTOUCH

The configuration should be:

CF04 = 0, (not Motor condensing unit)

CF02 = 2, (heat pump only)

SP09 = 0, (from the keyboard)





In the Visotouch, the right button is always visible and the left button is hidden. The right button will be shown as  when SP08 = 0 and shown as  when SP08 = 1.

Press this button for 1 second can switch the device status between heating mode and stand-by.

6.1.2 Unit Switch-ON/OFF From Digital Input

If the unit is switch off by remote digital input, the screen will be:

Unit Remote OFF		09:00 01/01/2013
Evap.IN temp.:	8.0 °C	
Evap.OUT temp.:	12.0 °C	
External air temp.:	7.0 °C	
Aux.out1 temp.:	10.0 °C	

From digital input configured as **remote ON/OFF** (DI type =1). When deactivate, on the basis of the polarity selected, the input determines the OFF status

- It has priority with respect to the keyboard
- The unit can only be switched-on and off with input activated
- With input activated, the device goes back to the status previous to activation

6.1.3 Select The Working Mode: Chiller-Heat Pump

The parameter SP09 allows selecting and enabling the selection of the unit switch-on mode in the three working modes.



Par SP09 = 0

The switch-on selection of a unit configured for cooling and heating takes place from the Visotouch.

AUTOMATIC WORKING SELECTION IN COOLING-HEATING MODE FROM DIGITAL INPUT

Par SP09 = 1

The switch-on selection of a unit configured for cooling and heating takes place from digital inputs configured as **Remote cooling/heating**(DI type=2). With digital input activated, cooling mode is selected, with digital input deactivated, heating mode is selected.

- The selection is enabled if a digital input is configured as cooling request or as heating request. If no digital input has been configured, the unit **REMAINS in stand - by**
- the cooling/heating selection from the keyboard is disabled. The unit can only be switched-on/off in the working status selected from the digital input
- CF02 is the precondition. If only CF02=3 the cooling/heating selection from digital input is available. Otherwise, the device working mode will be set by CF02.
- In the Visotouch, buttons for cooling/heating will be shown according to digital input status. E.g., digital input=cooling,  is visible and  is hidden. By pressing , the unit can switch between cooling and stand-by.

AUTOMATIC WORKING SELECTION IN COOLING-HEATING MODE FROM ANALOGUE INPUT

Par SP09 = 2

Selection from analogue input (change over function) has priority with respect to the digital input. For temperature of the external air included in the SP11 differential, it is allowed to change the working mode from the keyboard.

6.1.4 Change Over Function

SP10	Automatic chiller / heat pump mode changeover setting	-50.0 -58	110 230	°C °F	Dec int
SP11	Automatic chiller / heat pump mode changeover differential	0.1 1	25.0 45	°C °F	Dec int

The status change over can only take place if these necessary conditions are present at the same time, otherwise the unit **REMAINS in stand - by**:

4. CF02=3 (chiller with heat pump)
5. SP09=2 is an NTC probe configured as an **Dynamic/boiler function/change over set-point external air temperature NTC temperature probe**(AI type=35)
6. the regulation probe selected must not be in error conditions

AUTOMATIC CHANGE OVER REGULATOR GRAPHICS

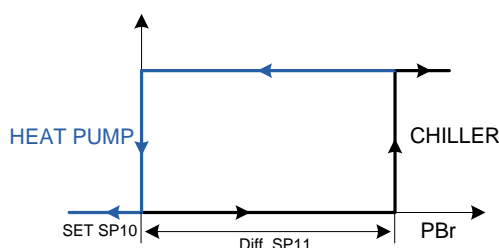

Parameters that regulated the change over function

SP10 allows setting the change over set point. If the selection of the working mode from analogue input is enabled, it represents the temperature value detected by the regulation probe below which the device imposes the working in heating mode

SP11 allows setting the change over differential. If the selection of the working mode from analogue input is enabled, it represents the temperature differential on the basis of which the device imposes the working in cooling mode

For temperature of the external air included in the SP11 differential, it is allowed to change the working mode from the keyboard.

NTC external air temperature regulation NTC probe > SP10+ SP11, the unit is switched-on in cooling mode.

NTC external air temperature regulation NTC probe < SP10, the unit is switched-on in heating mode.

6.2 UNIT SWITCH ON/OFF BY RTC

6.2.1 Working With Clock Disabling Digital Input

ES 1	Start of working time band 1 (0-24)	0	24.00	Hr	10 Min
ES 2	End of working time band 1 (0-24)	0	24.00	Hr	10 Min
ES 3	Start of working time band 2 (0-24)	0	24.00	Hr	10 Min
ES 4	End of working time band 2 (0-24)	0	24.00	Hr	10 Min
ES 5	Start of working time band 3 (0-24)	0	24.00	Hr	10 Min
ES 6	End of working time band 3 (0-24)	0	24.00	Hr	10 Min
ES18	Monday automatic shutdown time band	0	7		
ES19	Tuesday automatic shutdown time band	0	7		
ES20	Wednesday automatic shutdown time band	0	7		
ES21	Thursday automatic shutdown time band	0	7		
ES22	Friday automatic shutdown time band	0	7		
ES23	Saturday automatic shutdown time band	0	7		
ES24	Sunday automatic shutdown time band	0	7		

If the unit is switch off during switch-off time bands, the screen will be:

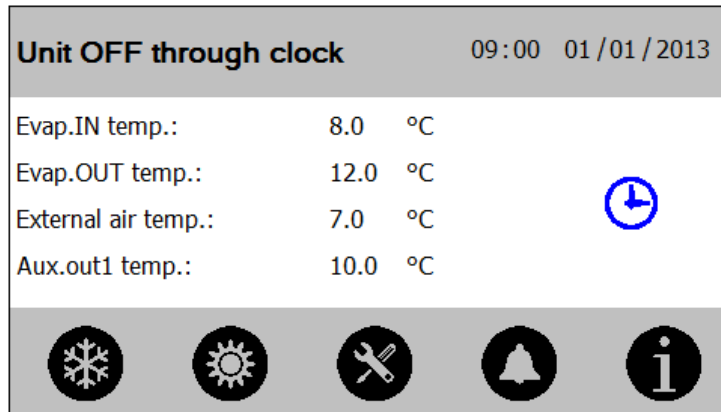

If a digital input is configured as **Digital input working in RTC automatic enabling (time band)/manual (keyboard) mode** (DI type=91) and is active, the working via the internal clock is disabled. Otherwise, if this digital input is not configured or configured but not active, enables the working via the internal clock.

The unit is forced to switch off within the time band.

Set the time band with Par ES01-ES06, and select weekly time band by Par ES18-ES24. If current time is inside the setting band, the unit will be shut off automatically, and the Visotouch shows "Unit OFF through clock".

The RTC time band also can be configured from Visotouch.

Enter into the **Set time/date/time bands** screen from **SERVICE** menu.

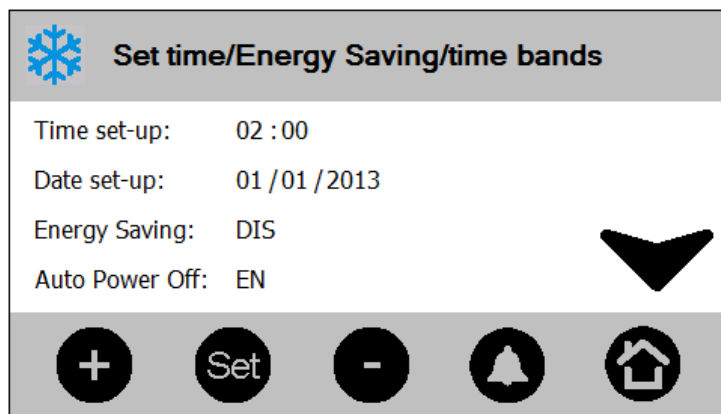

Enable the **Auto Power Off** option, set **Time band N1/N3** in page 2.

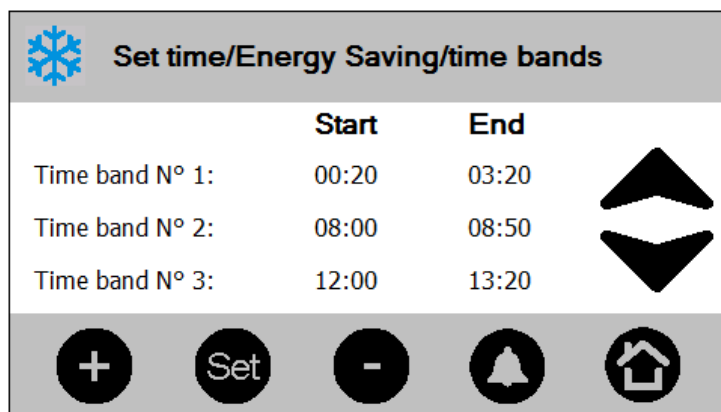

Select time band from **Monday** to **Sunday** in the next pages' last column **Auto On-Off**.

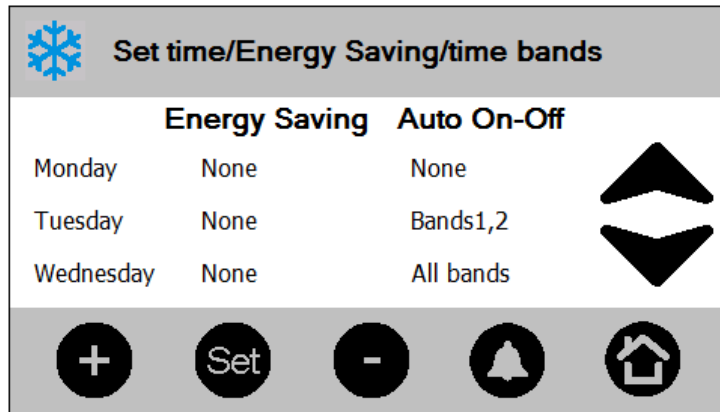

6.2.2 Working With “Ventilation Only” Digital Input (Air-Air Unit Only)

If the unit has been configured as AIR-AIR, during clock off, it is possible to decide whether to enable ventilation or not. When ventilation enabled, the screen will be:

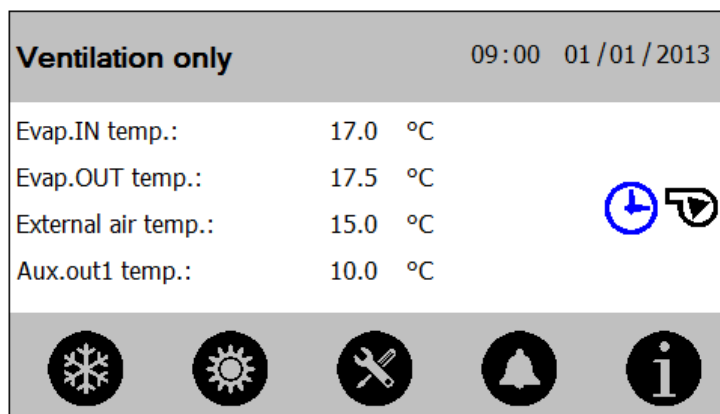

This working mode is only enabled if the clock is present and enabled.

Set CF01=0, select air/air unit.

Set ES01-06, ES18-24 to enable the function automatic shutdown by RTC.

If a digital input is configured as **Digital input working with supply fan only** (DI type=92) and is active, when current time is inside the automatic shutdown time band, the unit will work in “Ventilation only” mode.

In “Ventilation only” mode, only relay configured as supply fan is enabled.

After current time goes out of the automatic shutdown time band, the unit will back to normal working mode.

WARNING: In ventilation only mode, the supply fan will forced to active if unit is on. When the unit is placed in remote off or stand-by, supply fan will switch off after the delay time set in par PA03.

6.2.3 Working With Unit In OFF From RTC If ON Is Forced From Visotouch

ES25	Unit maximum working time in OFF from RTC if forced in ON from key	0	250	Min	10 Min
-------------	--	---	-----	-----	--------

When the unit is OFF by RTC, user can use Visotouch or digital input to force the unit ON. However, the ON time can't be longer than the time set by Par ES25. After ES25 time, the unit will be forced back to OFF status.

During ES25 time, user can manually switch OFF the unit by Visotouch or digital input.

6.3 OPERATION IN CONDENSING UNIT WORKING MODE

If CF04 = 1, the unit will work as Motor-condensing unit.

CF 4	Motor-condensing unit 0 = no 1 = yes Temperature control, dynamic set point and energy saving functions are automatically disabled when CF04 = 1	0	1		
-------------	---	---	---	--	--

WARNING:

In condensing unit working mode the temperature control, dynamic set-point function and energy saving function are disabled automatically

In condensing unit working mode, the cooling/heating capacity is only controlled by digital input configured as **Capacity step x demand digital input** (x can be 1 to 16. DI type = 96-111).

6.3.1 Working With Digital Input Configuration As Temperature Control Request

Unit configured as motor-condensing CF04 = 1.

Configure DI as **Cooling/Heating demand digital input (condensing unit)**. (DI type = 93)

- With DI contact NOT ACTIVE unit in **OFF**
- With DI contact ACTIVE unit in **cooling/heating**

With DI contact active, user can select the cooling or heating working mode by parameter CF02, SP09 and keyboard. The capacity steps will be called by DI configured as **Capacity step x demand digital input** (x can be 1 to 16. DI type = 96-111) if resources are available in the circuit.

With DI contact active, user can switch ON/OFF the unit by the keyboard. With DI contact not active, the unit will always OFF.

6.3.2 Working With Digital Input Configured As Cooling Request

Unit configured as motor-condensing CF04 = 1, CF02=1 or 3.

Configure DI as **Cooling demand digital input (condensing unit)** (DI type= 94)

- With DI contact NOT active unit is **OFF**
- With DI contact active unit is **ON** in chiller mode

With DI contact active, unit works in chiller mode. The capacity steps, if available, will be called by DI configured as **Capacity step x demand digital input** (x can be 1 to 16).

With DI contact active, user can switch ON/OFF the unit by the keyboard. If the unit has been switched-off from the Visotouch, user can re-start it by deactivate and re-activate the digital input.

6.3.3 Working With Digital Input Configured As Heating Request

Unit configured as motor-condensing CF04 = 1, CF02=2 or 3.

Configure DI as **Heating demand digital input (condensing unit)** (DI type= 95)

- With contact NOT active unit is **OFF**
- With contact active unit is **ON** in heat pump mode

With DI contact active, unit works in heat pump mode. The capacity steps, if available, will be called by DI configured as **Capacity step x demand digital input** (x can be 1 to 16).

With DI contact active, user can switch ON/OFF the unit by the keyboard. If the unit has been switched-off from the Visotouch, user can re-start it by deactivate and re-activate the digital input.

Working error



If two digital inputs are configured as cooling request and heating request with both inputs active at the same time, the unit will be positioned in OFF mode.

6.4 HOW TO MODIFY THE INFORMATION PRESENT IN THE MAIN SCREEN

6.4.1 Select Probes For Display

To select the probes to display on the Visotouch, modify the parameters from DP01 to DP04 (see Programming parameters chapters).

6.5 INFORMATION BUTTON IN MAIN SCREEN

Press the  button can enter in the Informations screen. In order to go back to previous screen, press the  button.

This screen is protected by password. The 2nd level or 3rd level password are all available.

- System information:

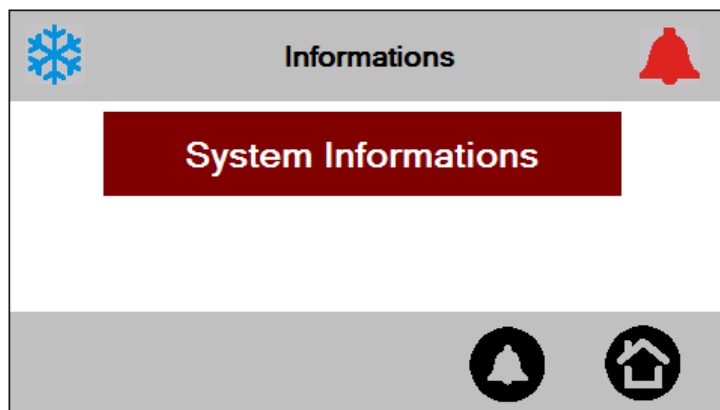
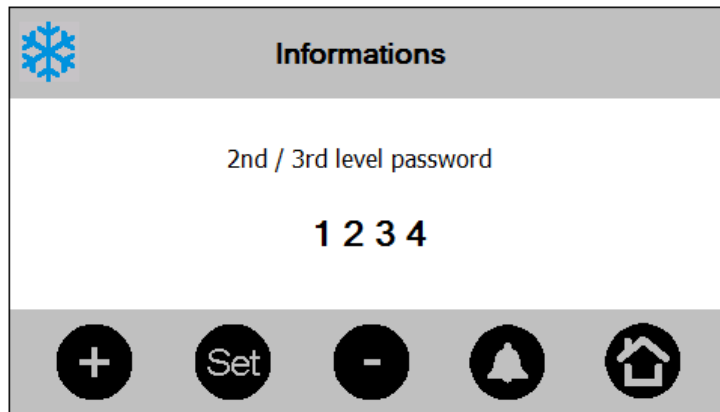

The IP address and ModBUS address are editable, but the modification will be actual at next reboot of the ipro.

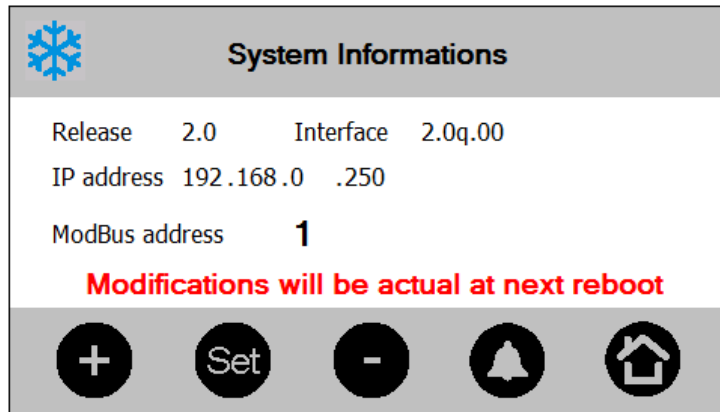





6.6 ALARM BUTTON IN MAIN SCREEN

When an alarm occurs, the screen shows the flashing icon , the red LED switch ON and the buzzer starts to operate. Press anywhere on the screen can silence the buzzer.

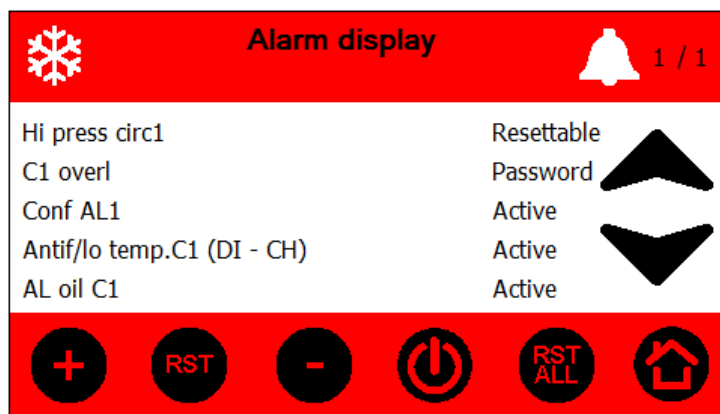
Push button  can enter in the Alarm display screen. In order to go back to previous screen, please press the  button.



Three types of alarms can be present:



- Resettable → in this case, the alarm is not active and can be reset. Position the cursor on the alarm element and press .
- Password → in this case, the alarm is not active, but a password is required to reset it.
- Active → the alarm is still in progress.

If there are several resettable alarms, instead of selecting them one by one, press  and they will all reset together.

To reset an alarm that is protected by a password, operate as follows:

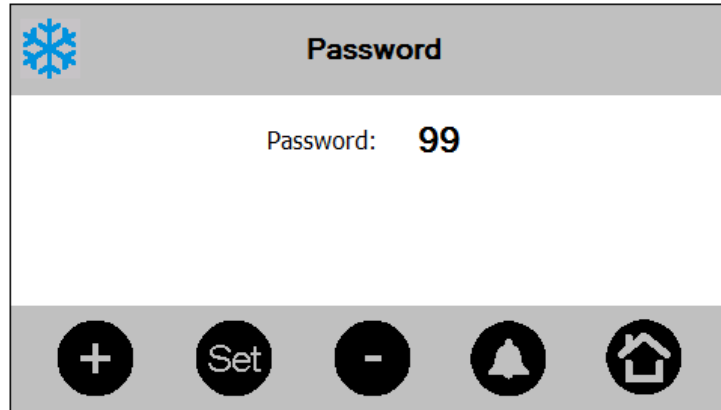
- Select the alarm marked by "Password".
- Press .



- Via buttons  and , set the password.
- Press  to confirm.
- If the password is correct, the following message will display:

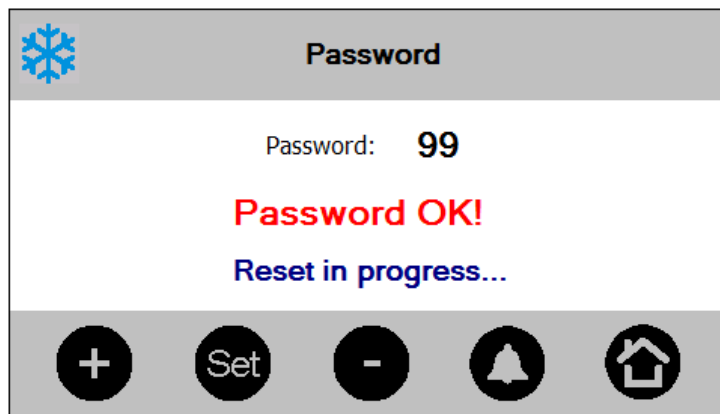

- If the password introduced is incorrect, the following message will display:

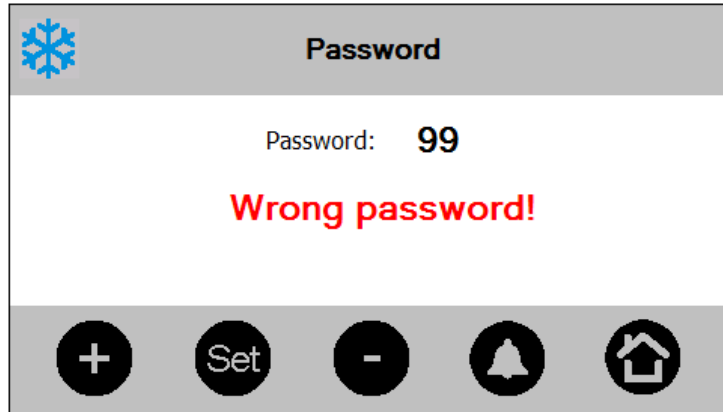

If the password is correct, after a few seconds you will go automatically back to the alarms screen.

6.7 FREE BUTTON IN MAIN SCREEN

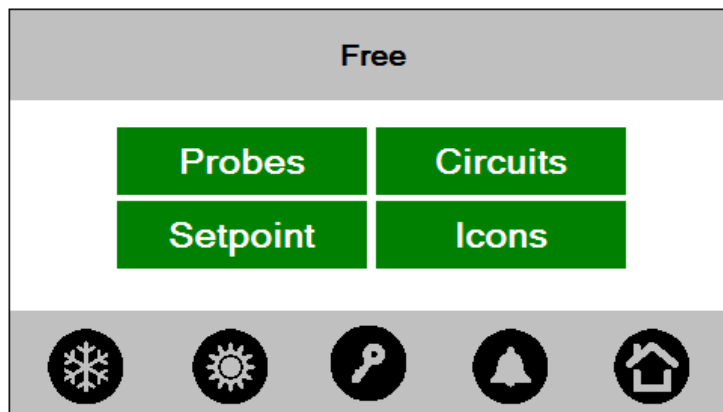

Press button  can enter in the Free screen. It has 4 sub menus.

- **Probes:** Show the global probes' value. They are not dedicated to any circuit.
- **Setpoint:** Show the configured setpoint value and the real setpoint value in use considering energy saving and dynamic setpoint.
- **Circuits:** Show the probes' value belong to each circuit.
- **Icons:** Show the loads' status of all configured circuits (including compressors, pumps, and fans).

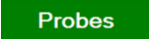

6.7.1 Probes Submenu

Press  button in Free screen can enter in the Probes screen.

By pressing the  and  buttons, all the relevant probes can be seen.

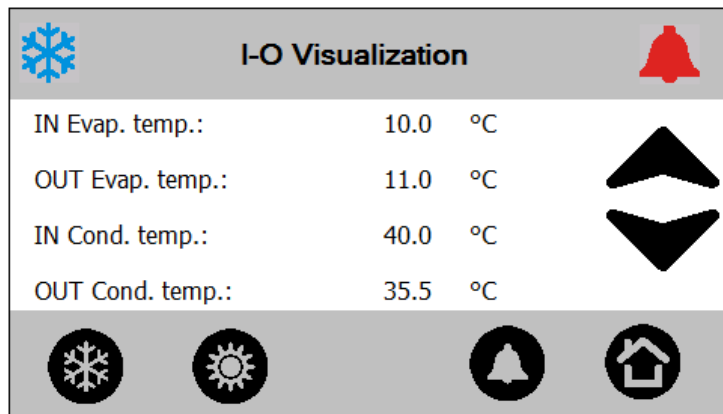
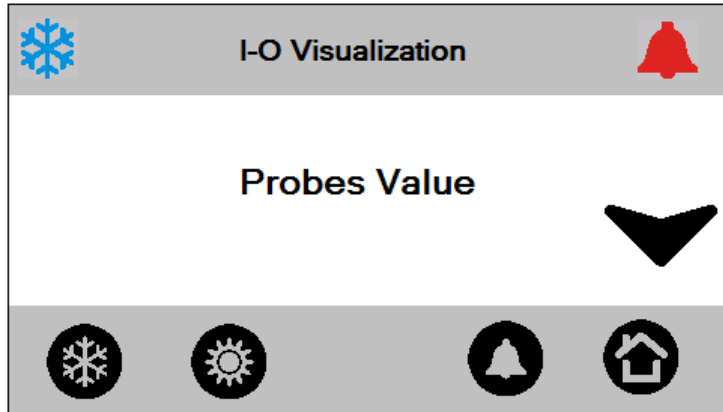

Press the button several times to go back to the main screen.

6.7.2 Setpoint Submenu

To set the setpoint of the cooling and/or heating, press button and enter the set-point screen.

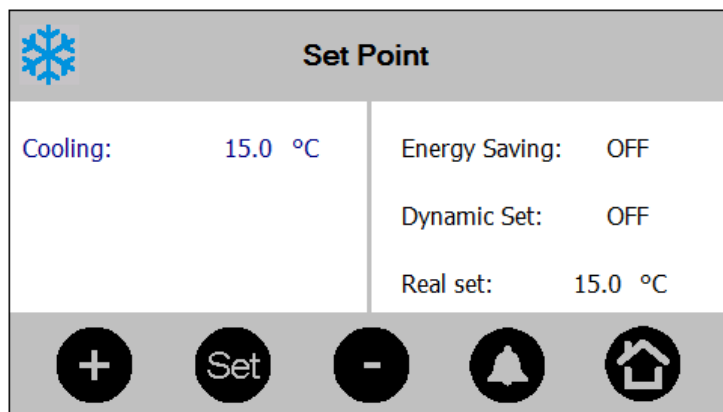

Chiller mode:

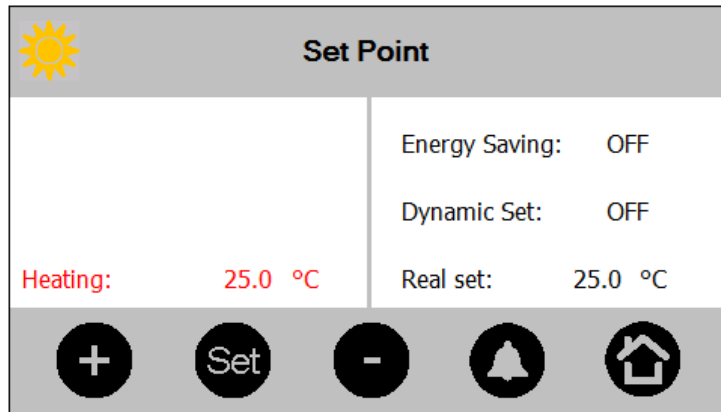

Heat pump mode:



To modify the setpoint, click the element “Cooling” or “Heating” setpoint then press the  button:

- The element starts to flash.
- Increase or decrease the value using the  and  buttons.
- Confirm the modification by pressing the  button again.

In this screen it is also possible to verify (but not modify) whether the energy saving mode and dynamic set are active. If they are active, the **Real set** may different from the **Cooling** or **Heating** set.

Cooling (Heating) set is always the same as par ST01(ST04), the **real set** represent the set-point value including the energy saving delta or of the dynamic set, and it is read only (can't be modified).

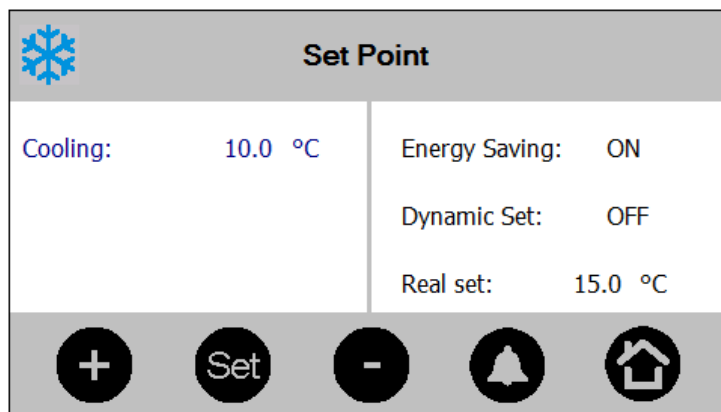

If heat recovery is enabled (RC01>0), the recovery set point will also be shown in this screen.

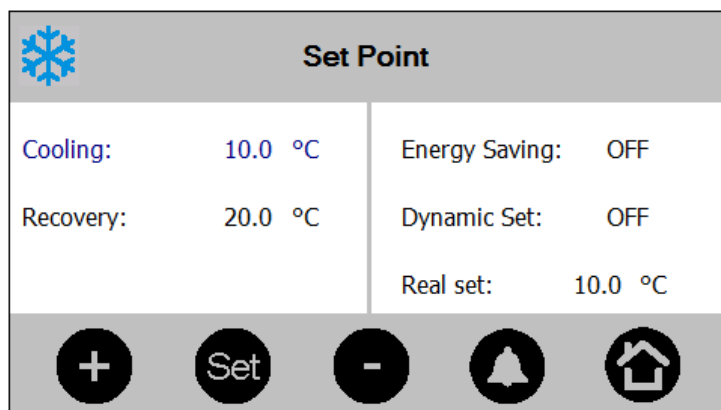

Press the  button can exit current screen.

6.7.3 Circuits Submenu

Press the  button in the Free screen can show probes' value of each circuit.

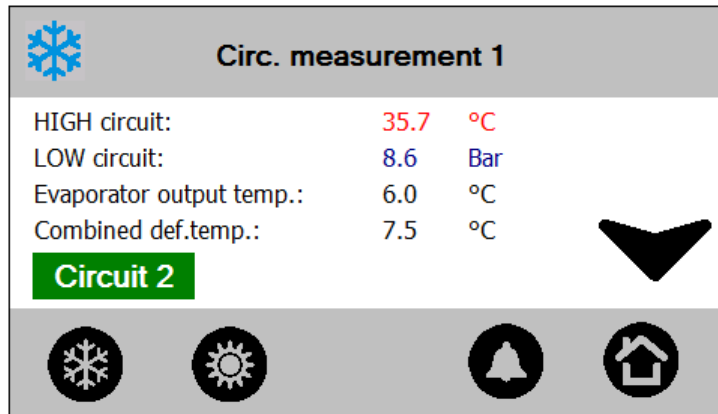

If two circuits are configured, press  button can switch the display to circuit 2.

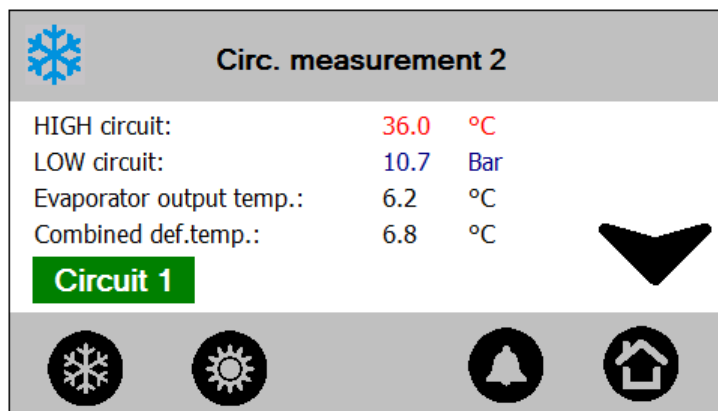

6.7.4 Icons Submenu

Press the  button in the Free screen is possible to monitor the loads' status of the unit. The information refers to:

- Circuits compressors status; the screen shows the compressors present for each circuit and the activation status of the compressor (number of unloaders active). If the compressor has no number on the right, it means that it is at full power.
In the screen below, circuit 1 has 2 compressors configured. Compressor 1 running at full power, compressor 2 running at 1st power step. circuit 2 has 1 compressors configured and it is not working now.

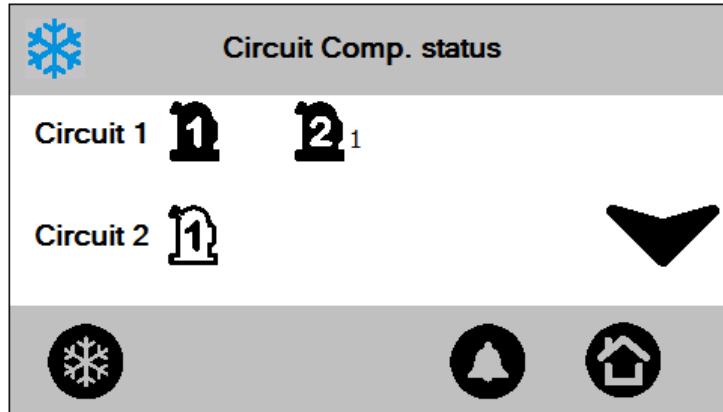

If unloading is active, the maximum step number for unloading will be displayed.

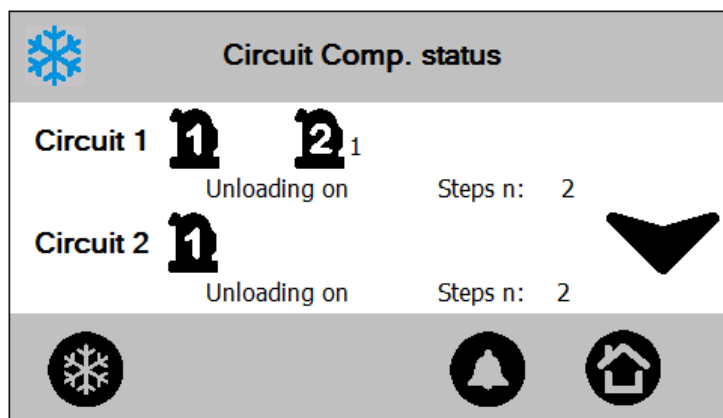

- Condensation-evaporation probes. The screen shows the condensation and evaporation pressures of every circuit present.

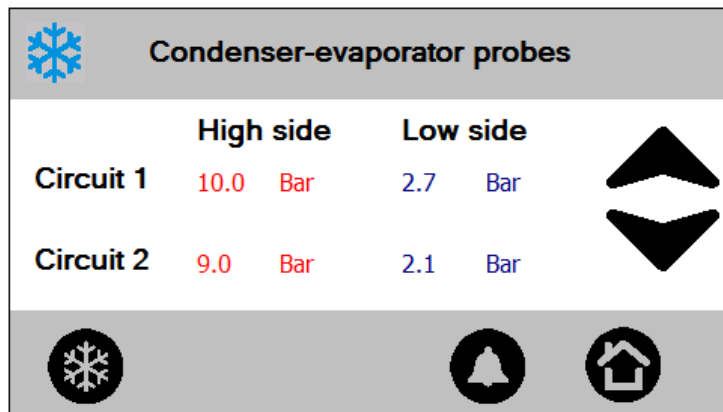

If the value of the parameter SP01 is equal to "0" or "2", the high side is represented with the temperatures.

- Status of the evaporator pump (or evaporator pumps if the support is present)

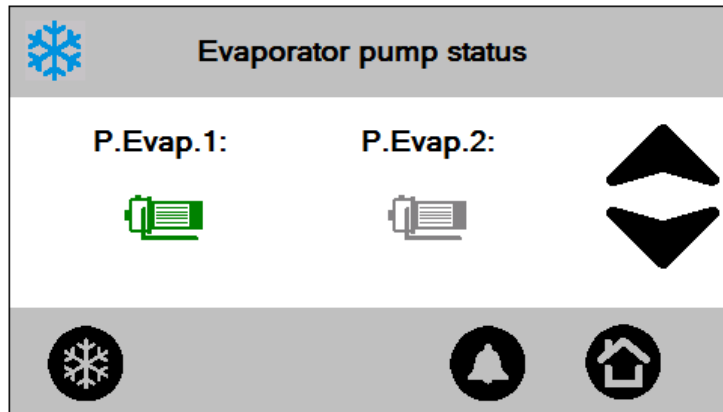

- Status of the supply fan

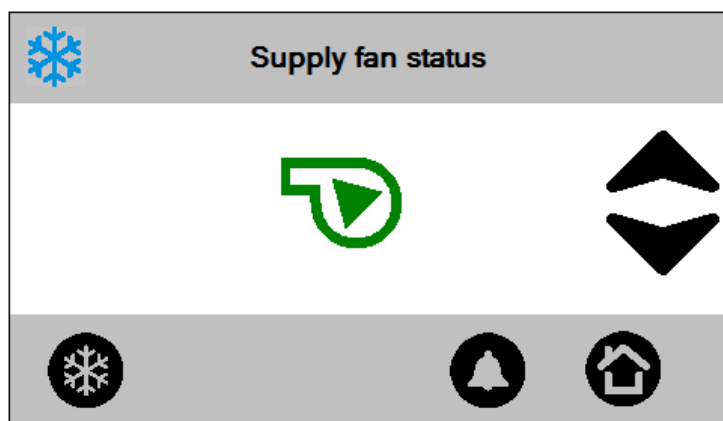

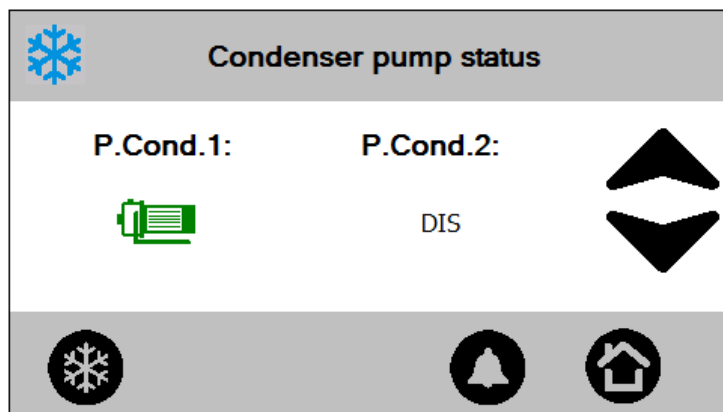

- Status of the condenser pump (or of the pumps if the WATER-WATER support is present)

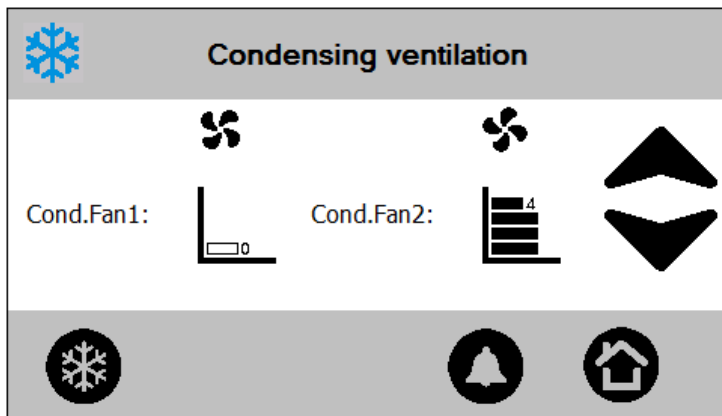
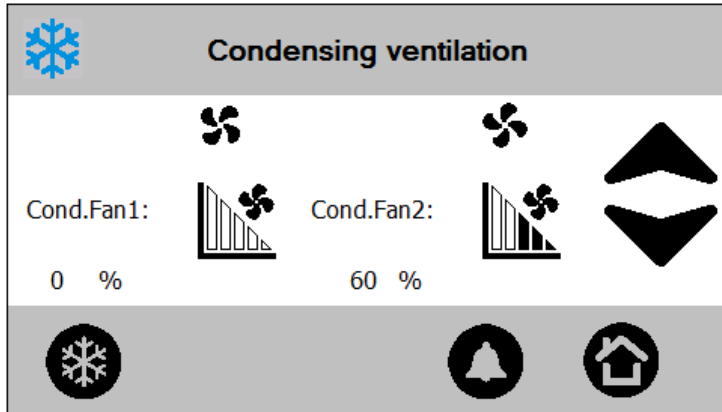

- Condensation fans (proportional or with steps - AIR-AIR or AIR-WATER)



By pressing the  or  buttons, can pass from one screen to another.

- Refcomp compressor information
If Refcomp compressor is configured, press key **RefComp** to see relevant information.

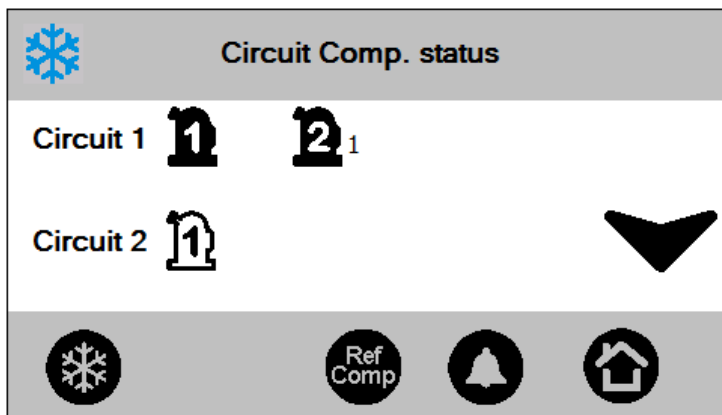

Refcomp Compressor

Indirizzo Modbus 1

Frequency	60.00 Hz	
Speed	500 rpm	▼
Current	10 A	

VI 🔔 🏠

Refcomp Compressor

IGBT temper.	15.0 °C	▲
DC-Link Volt	24 V	
Alarm 1	0	▼
Card temper.	20.0 °C	

VI 🔔 🏠

Refcomp Compressor

Running Time	100 h 0 m 0 s	▲
I2t Time	10 h 0 m 0 s	
Motor PTC	20 ohm Alarm 2	
I2t expire time	10 sec Status 1	
I2t condition	30 %	

VI 🔔 🏠

In the screen above, the modbus address is editable.

- Refcomp compressor valve status
Press  button to see the valve status

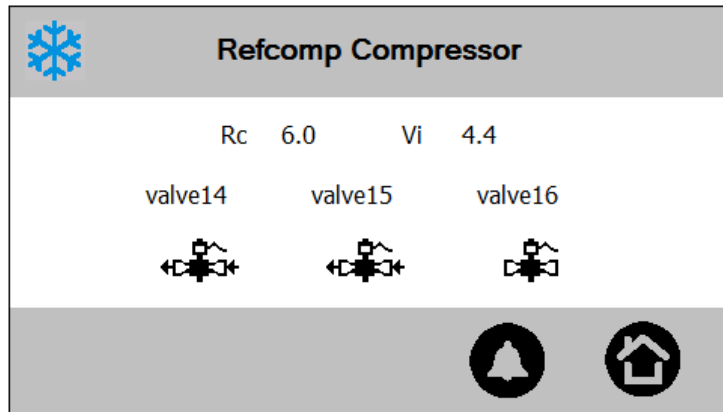

6.8 SERVICE MENU

In screen Free, press the  button on the bottom can enter in the SERVICE menu.

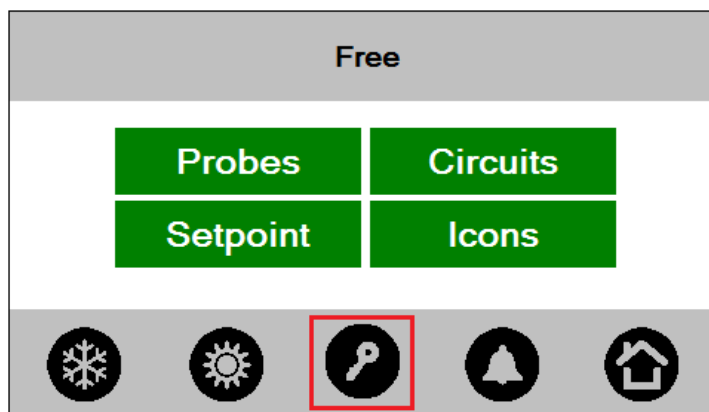

In SERVICE menu is possible to configure:

- Parameters Programming
- Time/Time periods Programming
- Compressors
- Water pump (Supply fan)
- Alarms display
- Historical alarms
- Defrost
- Heaters/Liquid line solenoid valve
- I/O status (Inputs and Outputs)
- Thermostatic Valve
- Heat recovery function
- Auxiliary outputs
- Free-cooling
- Screw compressor
- Discharge compressor temperature
- Sanitary water (Domestic hot water)
- Auxiliary heating
- Control panel

The SERVICE menu is protected by password in 3 levels.
For 1st level, no password needed. Press key ENTER can enter in SERVICE menu directly.

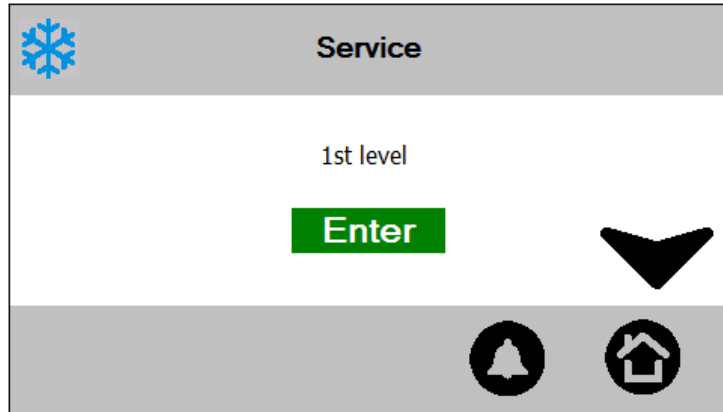

Press  button can switch to higher user level.
For 2nd and 3rd level, relevant password is required.

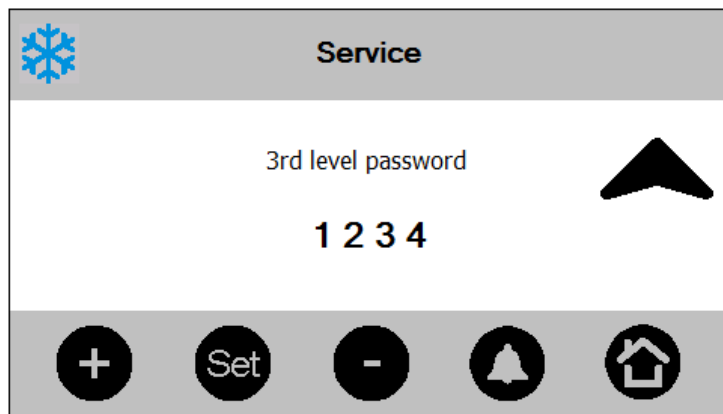
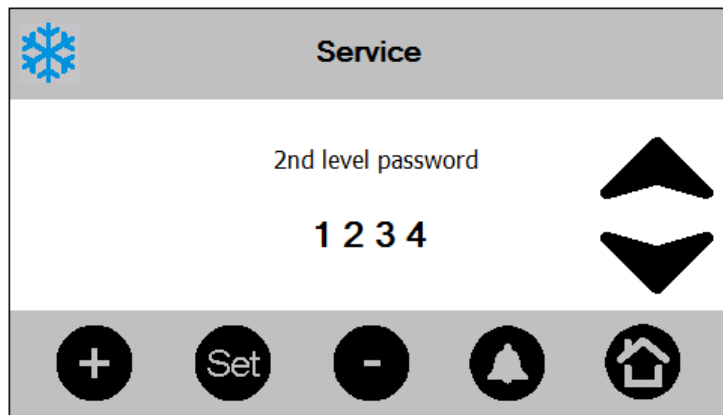

6.8.1 Parameters Programming



By selecting this menu it is possible to modify the value of the parameters depending on the password level. The parameters are divided per groups with the following meaning:

Label	Meaning
ST	Display temperature control parameters
DP	Display variables to be shown on the keyboard
CF	Display configuration parameters
SP	Display parameters for machine set up
Sd	Display dynamic set-point parameters
ES	Display energy saving and automatic timed switch-on/off parameters
AH	Display auxiliary heating parameters
CO	Display compressor parameters
SL	Display stepless compressor parameters
PA	Display evaporator/condenser water pump parameters
Pd	Display pump down function parameters
Un	Display unloading function parameters
FA	Display ventilation parameters
Ar	Display anti-freeze heaters parameters
dF	Display defrost parameters
rC	Display heat recovery parameters
FS	Display production of domestic hot water parameters
FC	Display free-cooling function parameters
US	Display auxiliary output parameters
AL	Display alarm parameters
Et	Display parameters for the management of the electronic expansion valve
IO	Display inputs/outputs configuration parameters
CA	Display analog input calibration parameters
RA	Display analog input range parameters

According to user level, different amount of parameters are visible in the parameters programming screen.

- If user entered into SERVICE menu with 1st level, he can enter to see parameters in Level 1(Pr1).
- If user entered into SERVICE menu with 2nd level, he can enter to see parameters in Level 1(Pr1) and Level 2(Pr2).
- If user entered into SERVICE menu with 3rd level, he can enter to see parameters in Level 1(Pr1), Level 2(Pr2) and Level 3(Pr3).





In the selected level screen, user only can see parameters with equal or lower protecting level. For example: When enter into 2nd level parameters screen, only parameters with Pr1 or Pr2 are displayed.

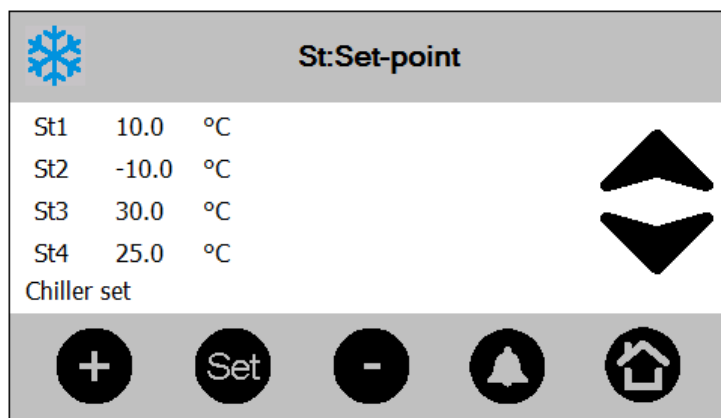
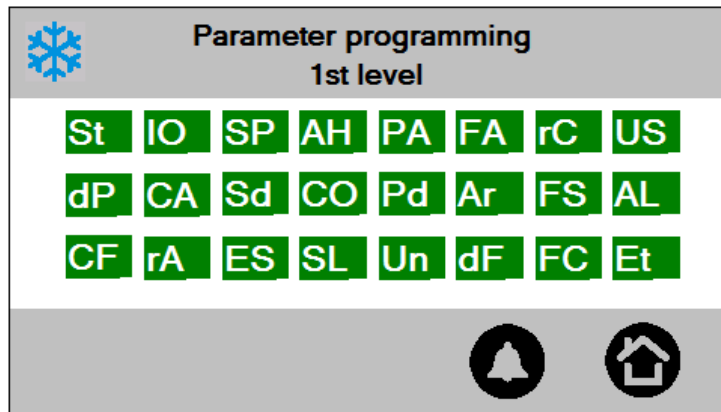

And user can change a parameter's protecting level to Pr1 or Pr2 in this screen.

Click on the family name label can open this parameter family.



To modify a parameter, click on the value:

- Press the  button.
- Increase or decrease the value using the  and  buttons.
- Confirm the modification by pressing the  button again.

 and  buttons also can be used to move the cursor. When cursor points to different parameters, the parameter's description will display in the bottom.

Press the  button can exit current screen.

Warning:

For parameter groups CF, IO, CA, and RA, they can be verified and changed only if the unit is switch-OFF (stand-by).

6.8.2 Time/Time Bands





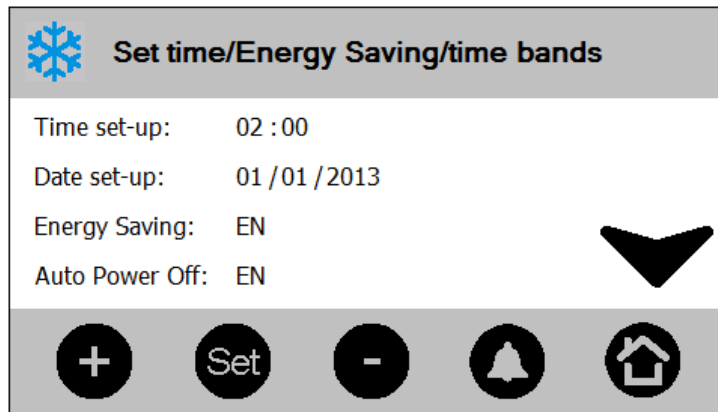

As mentioned in previous chapter, this menu is used for the time and date set. It is also possible to enable or disable the Energy Saving and/or automatic switch on/off the time bands.

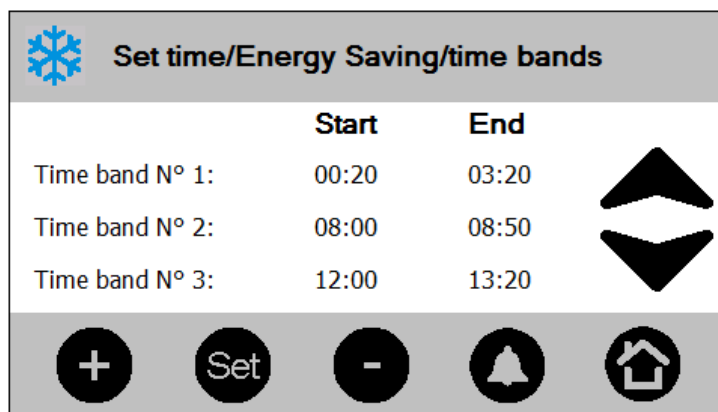

By pressing the  button, pass to the screen for the configuration of the three time bands.



To modify the time bands, click on the time:

- Press the  button.
- Increase or decrease the value using the  and  buttons.
- Confirm the modification by pressing the  button again.

By pressing the ▼ button again, pass to the screen for weekly programming of the time periods for the Energy saving and for automatic switch-off.

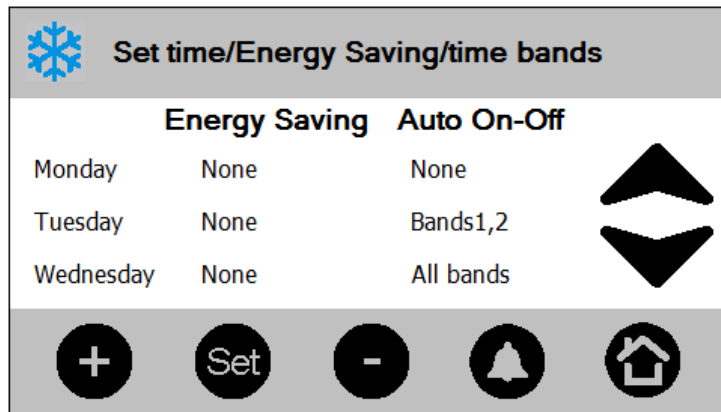

For every day of the week and for both functions(Energy saving and Auto On-Off), it is possible to manage:

- No time band
- Band 1
- Band 2
- Band 1 and 2
- Band 3
- Band 1 and 3
- Band 2 and 3
- All bands

Warning: Automatic switch-off has priority with respect to Energy saving

Press the 🏠 button can exit current screen.

6.8.3 Compressors



The following information is available for each circuit in this menu:

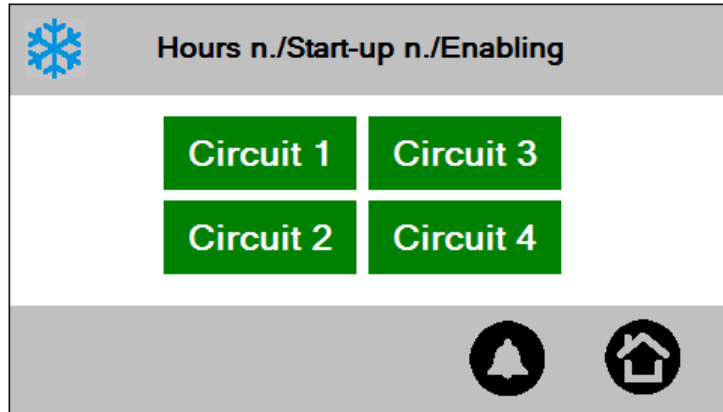

- Hours worked by each individual compressor
- Number of start-ups for each individual compressor

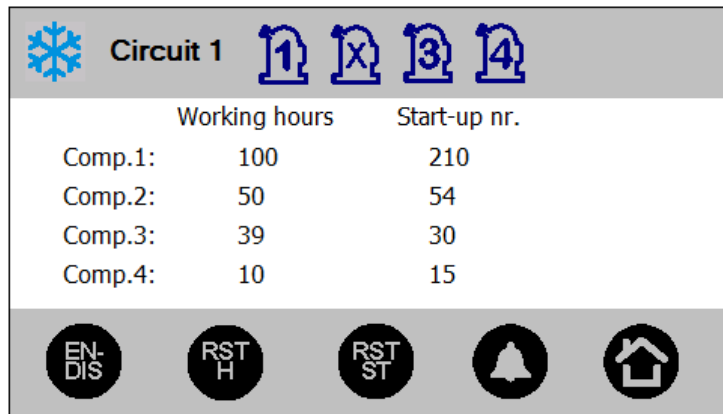

For each individual compressor it is possible:

- To reset the working hours
- Reset the number of start-ups
- Disable compressor working (e.g. in order to perform maintenance)



To reset the values, click on the compressor name label, and press the  or  button. And the password is request for reset operation (password is set by Par. AL31).

To enable or disable a compressor, click on the compressor name label, and then press the  button.

6.8.4 Water Pump

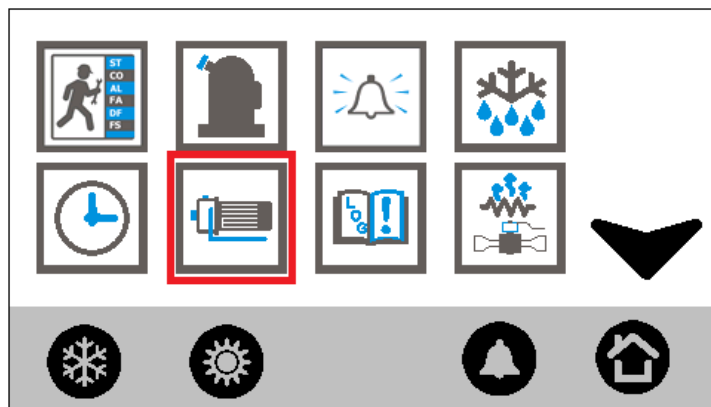

When CF01=0 (Air/air unit), instead of pump icon, the fan icon will display in the same position.











The following information is available in this menu:

- Hours worked by each individual pump (evaporator and condenser)

For each individual pump it is possible:

- To reset the working hours
- To disable the pump (e.g. to perform maintenance)

 Supply Fan	Working hours
 Evap water pump	21
 Support evap.water pump	15
 Condenser water pump	8
 Support cond.water pump	12







To reset working hours or disable/enable the pumps, follow the procedure described for the compressors. Password is request for reset operation (password is set by Par. AL31).

6.8.5 Alarms Display

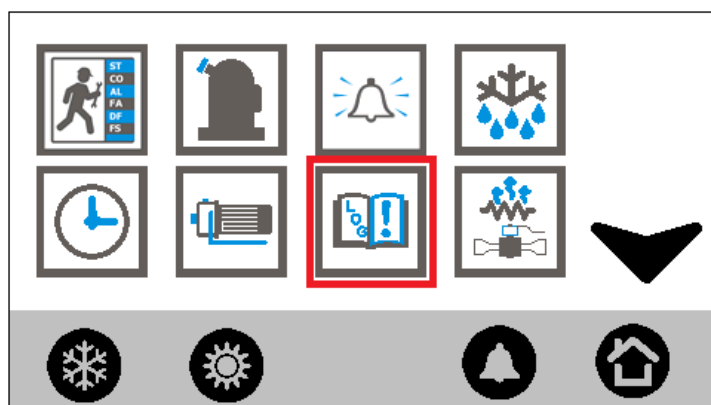
This menu contains the same information as press the  button in the main screen. See previous chapters for your reference.

6.8.6 Historical Alarms





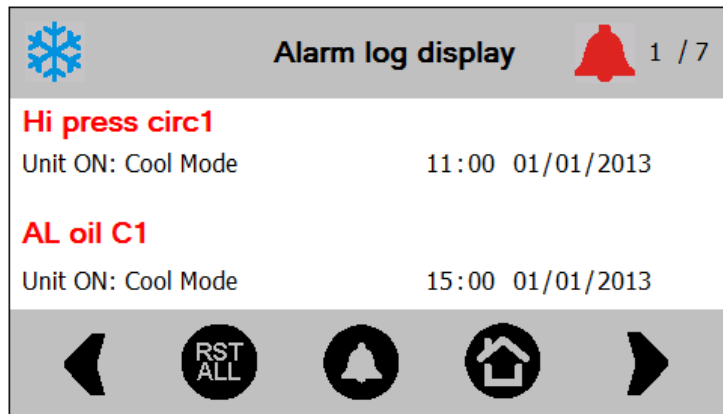

All alarms occurred are memorised in this screen.

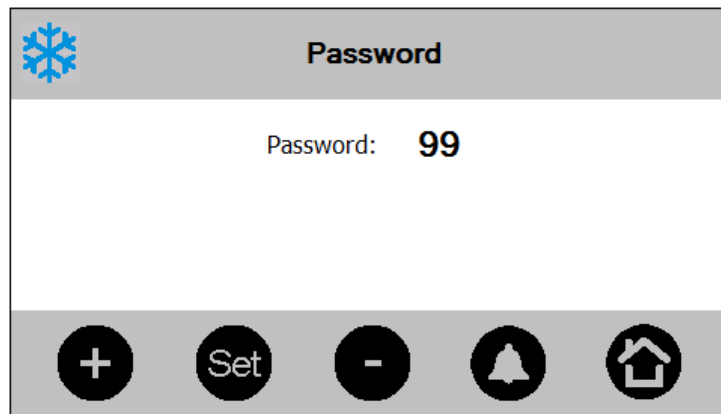

To reset the alarms log, operate as follows:

- Press the  button for 3 seconds.



- Via buttons  and , set the password.
- Press  to confirm.
- If the password is correct, the following message will display:

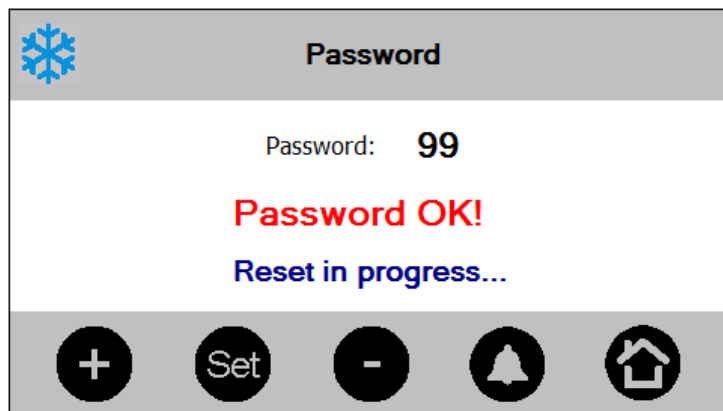

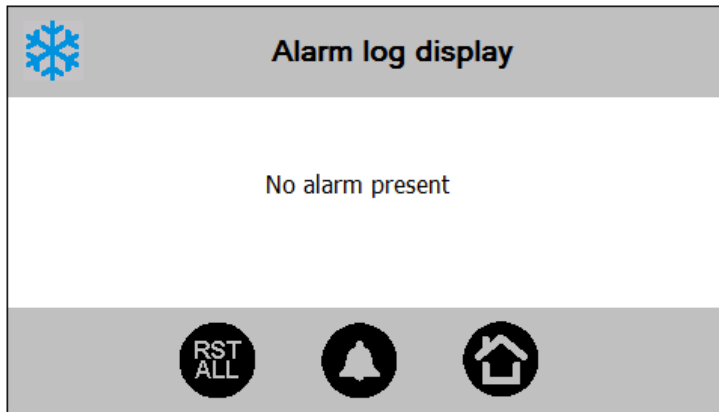

- If the password introduced is incorrect, the following message will display:

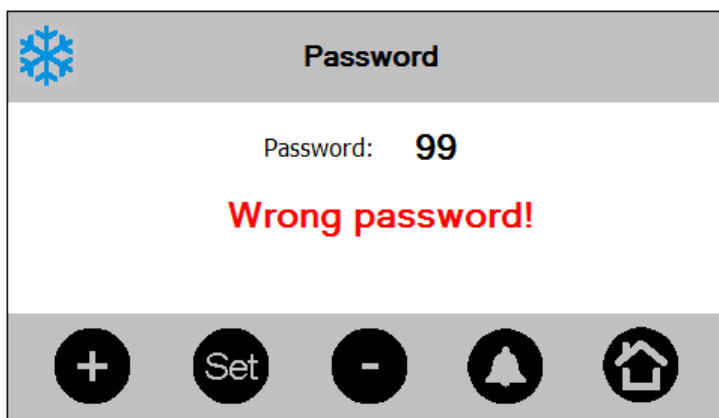

If the password is correct, after a few seconds you will go back automatically to the Alarm log screen.

6.8.7 Defrost



In this screen it is possible to check the status of the defrost cycle for every circuit present:

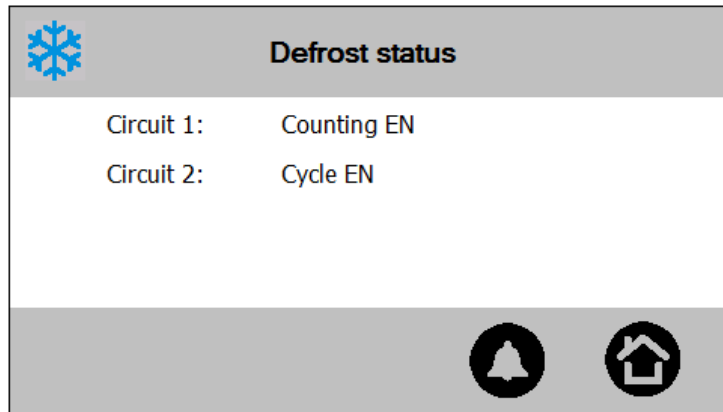



Circuit defrost status can be:

- Counting EN: In counting down, defrost will start soon
- Cycle EN: Defrost in progress
- Drip time EN: In dripping time
- Waiting: No defrost, normal working
- Condition not present: No necessary condition for defrost

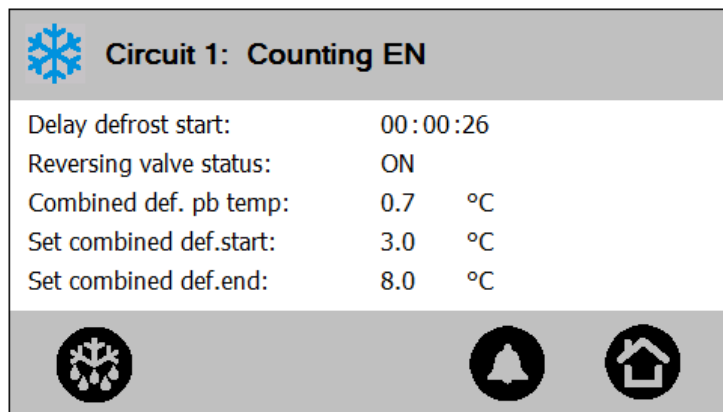
Click on the circuit label can pass to the following screen.



Press the  button for 5 seconds allows forcing start of the defrost cycle.

Press the  button can exit current screen.

6.8.8 Heaters/Liquid Line Solenoid Valve



This menu allows to display the active and/or deactivated heaters and any active and/or deactivated liquid line solenoid valves (only the resources configured are displayed).

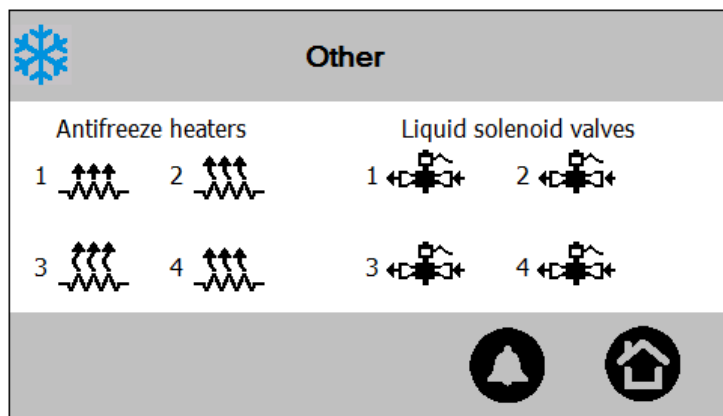

Press the  button can exit current screen.

6.8.9 I/O Status

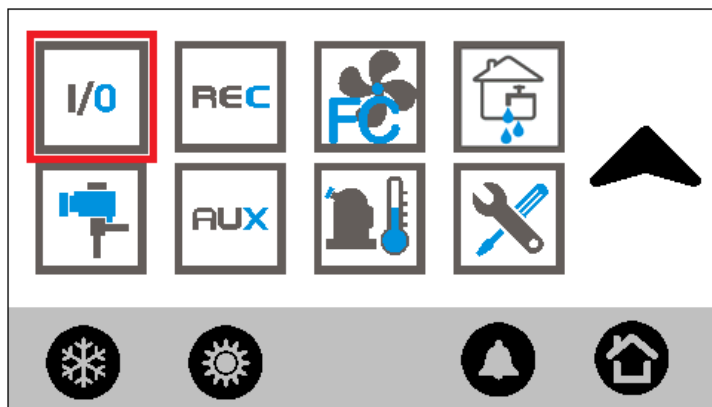

This menu allows to display the status of all inputs and outputs that have been defined.

The I/O units have been divided by groups, as in the screen below:

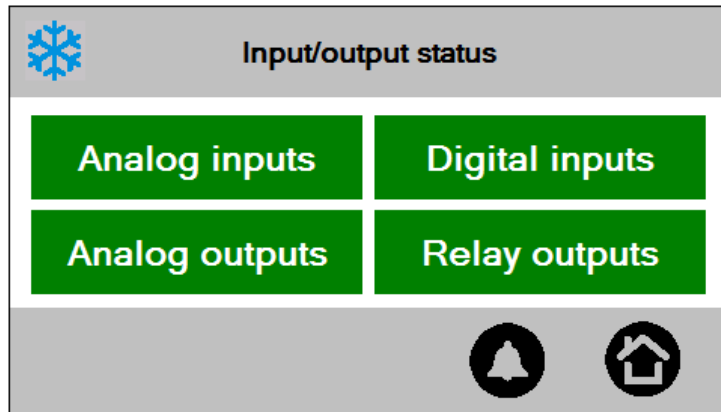

Click on the Analog inputs/Digital inputs/Analog outputs/Relay outputs button, it is possible to enter in the corresponding I/O screen.

Analog inputs:

Analog inputs		iPro	
Pb01	-1.5 °C	Pb04	Open °C
Pb02	10.0 °C	Pb05	13.2 °C
Pb03	N.C. °C	Pb06	8.0 °C

Digital inputs:

Digital inputs		iPro	
DI01	Open	DI05	Open
DI02	Closed	DI06	Closed
DI03	N.C.	DI07	Open
DI04	Closed	DI08	N.C.

Relay outputs:

Relay outputs		iPro	
RL01	ON	RL05	ON .
RL02	OFF	RL06	OFF.
RL03	OFF	RL07	N.C.
RL04	N.C.	RL08	N.C.

Analog outputs:

Analog outputs		iPro	
OUT1	100.0	%	
OUT2	N.C.		
OUT3	OFF.		
OUT4	20.0	%	

Press the  button can exit current screen.

6.8.10 Thermostatic

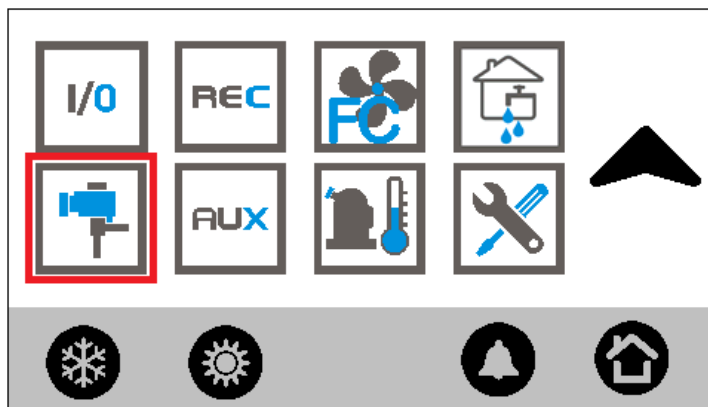

In this menu it is possible to check the working status of the valve and/or electronic thermostatic valves for every circuit defined.

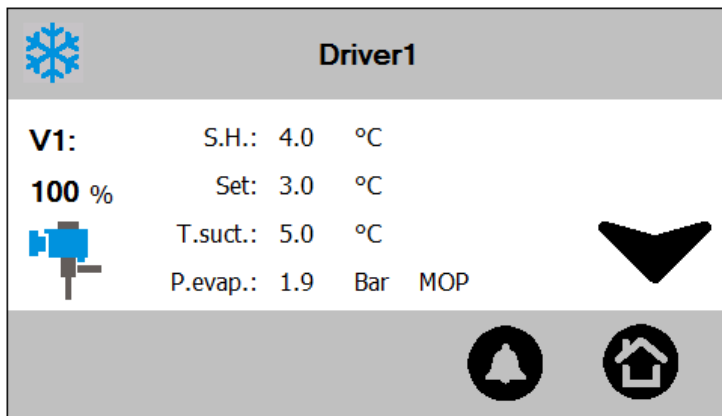
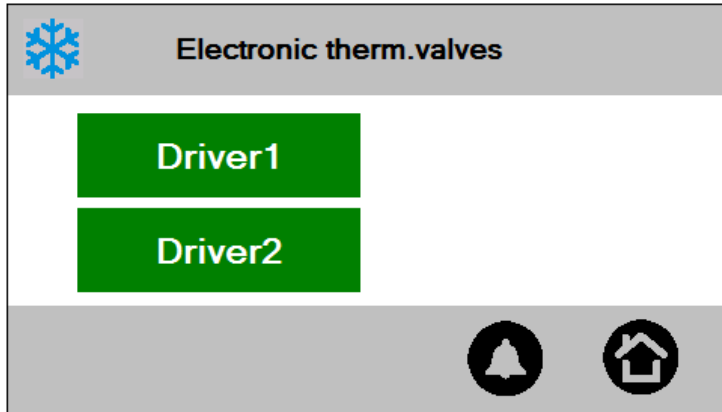

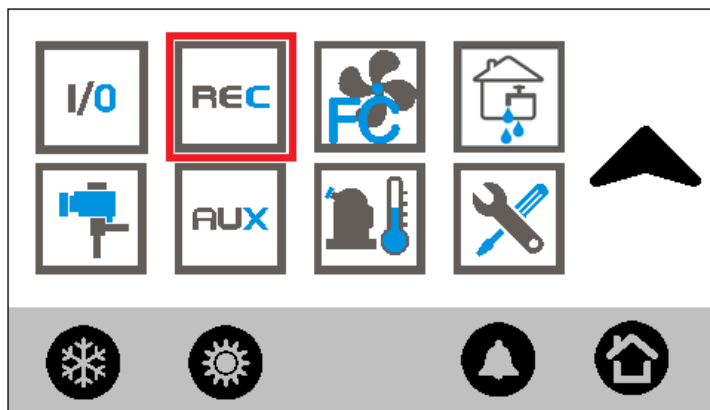

Press the  button can exit current screen.

6.8.11 Heat Recovery

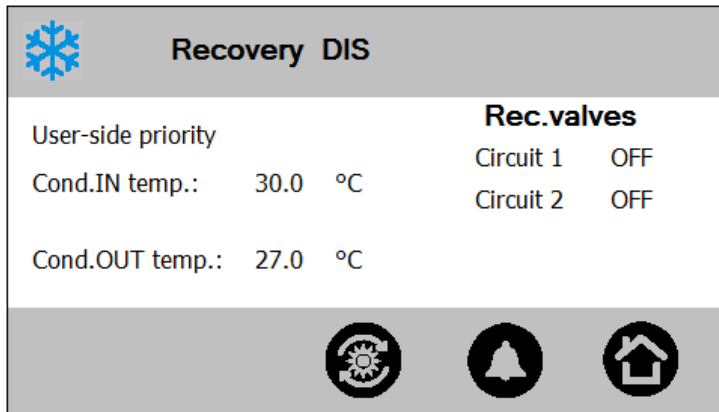

Using this menu it is possible to verify the recovery working status.



Press the  button for 1 second enables the recovery working.

The following information can be available in this screen:

- Status of the recovery function:
 - Disabled
 - Disabled from key
 - Enabled
 - Active
- Type of priority:
 - User side
 - Recovery side

Press the  button can exit current screen.

6.8.12 Auxiliary Outputs

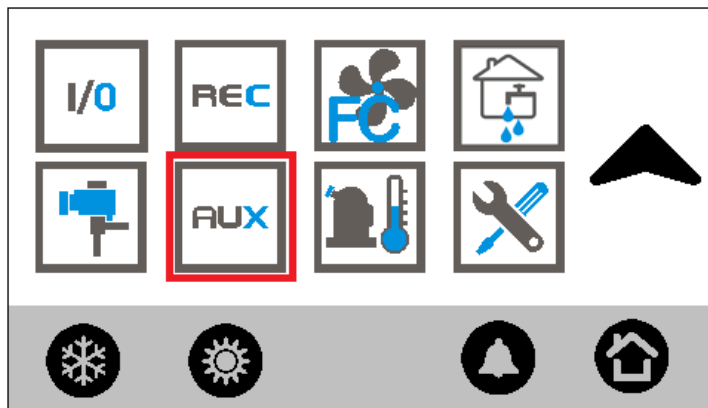

Using this menu it is possible to display the status of the auxiliary outputs (if present).

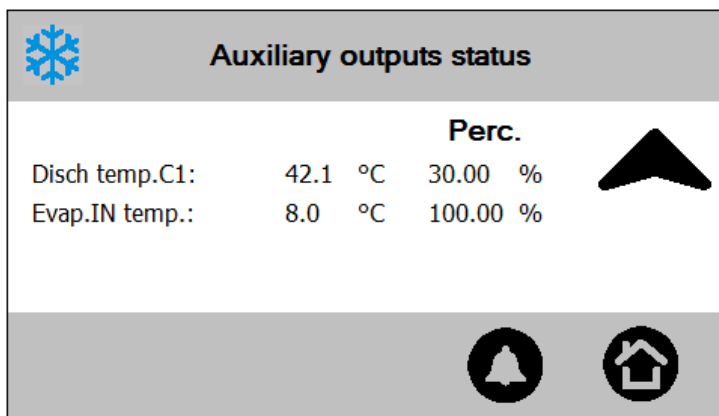
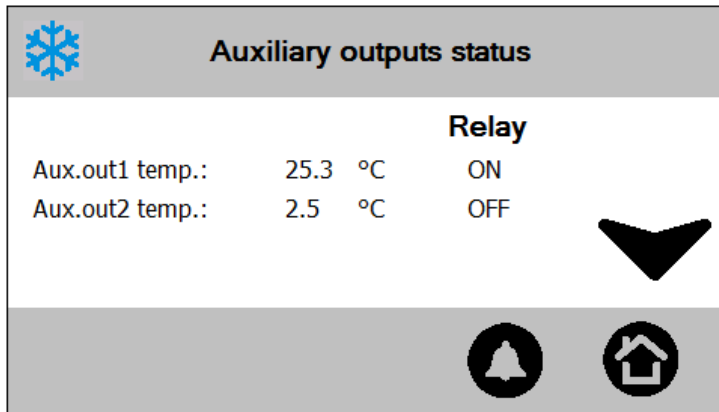

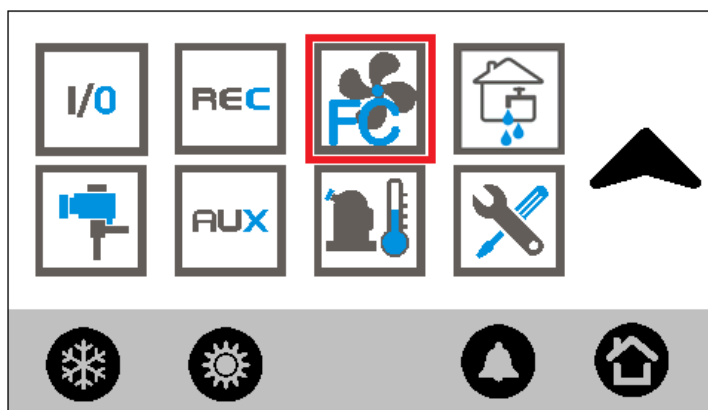

Press the  button can exit current screen.

6.8.13 Free-Cooling

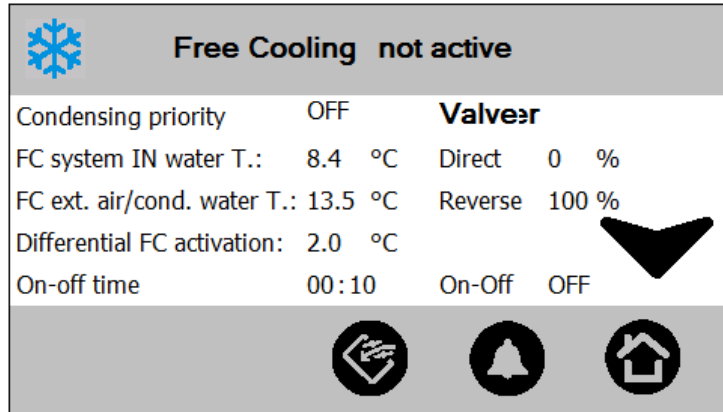

In this menu it is possible to verify the free cooling working status.
If FC01 \neq 4, this following screen will display:





Press the  button for 1 second can enable the free cooling working.

The following information can be available in this screen:

- Status of the free cooling function:
 - Not active
 - Disabled from key
 - Disabled from anti-freeze
 - OFF
 - ON
- Type of priority:
 - Condensation
 - Free-cooling
 - External ventilation

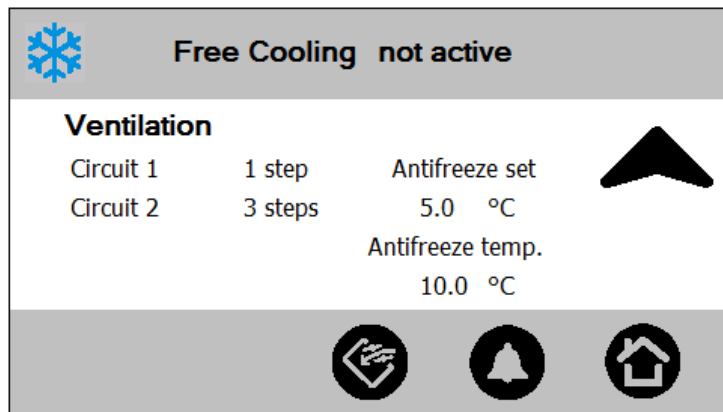
By pressing the  button can pass to the next screen where the following information is available (only if CF01≠0):



Press the  button can exit the current screen.



If FC01 = 4, the following 3 screens will display. Press  and  buttons can switch between the following screens:



 **Free Cooling not active**

FC system IN water T.: 9.1 °C Set: 9.0 °C 

FC ext. air/cond. water T.: 12.4 °C Set: 13.0 °C 

External air temp.: 12.0 °C Set: 10.0 °C

Valve 0 % V1  V2 

  

 **Free Cooling not active**



Ventilation

Circuit 1 1 step Antifreeze set 

Circuit 2 3 steps 5.0 °C

Antifreeze temp. 

10.0 °C

 **Free Cooling not active**



Delay from Ext air temp. 02 : 00 

Delay from Cond water temp. 0 : 32

Valve switch delay 0 : 45

FC exit delay 1 : 00

Antif prevention delay 1 : 10

Delay in free-cooling:

- Delay from Ext. air temp.: Count down from parameter FC03
- Delay from Cond water temp.: Count down from parameter FC19
- Valve switch delay: Count down from parameter FC20
- FC exit delay: Count down from parameter FC23
- Antif prevention delay: Count down from parameter FC24

Press the  button can exit current screen.

6.8.14 Screw Compressor

If CO09 = 2/3, screw compressor is used. The icon is shown as picture below.

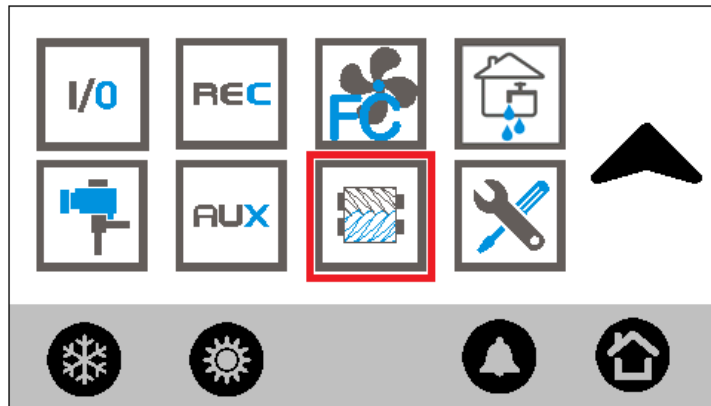

This menu can be used to monitor the working status of the screw compressor in each circuit.

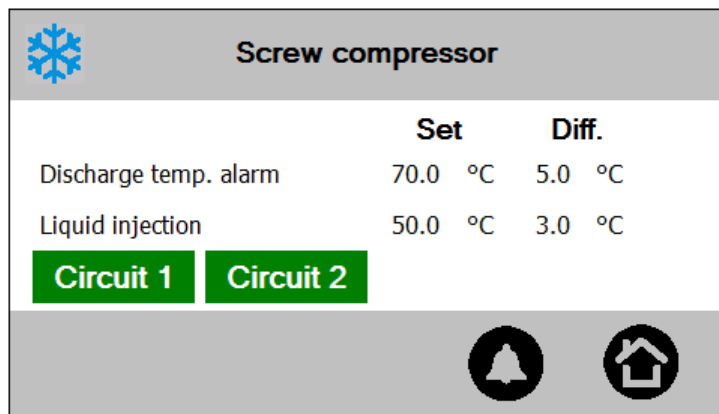

By selecting the desired circuit and click on its label, the following information can be displayed:

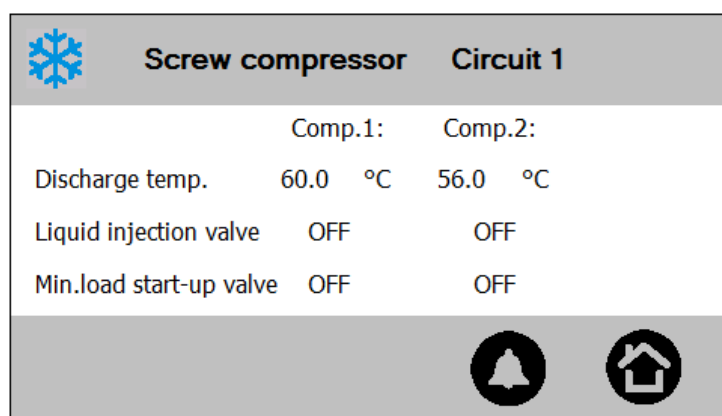

Press the  button can exit current screen.

6.8.15 Discharge Compressor Temperature

If CO09 = 0/1, discharge compressor icon is shown as picture below.

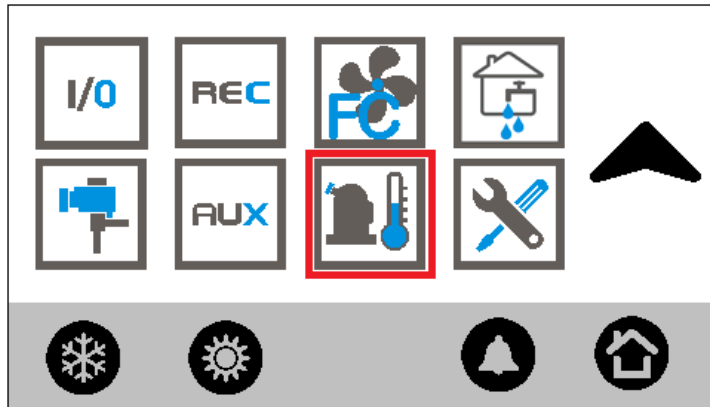

In this screen, if the probe: **compressor 1...16 PTC discharge temperature probe** (AI type=1 to 16) is configured, its value will be displayed.

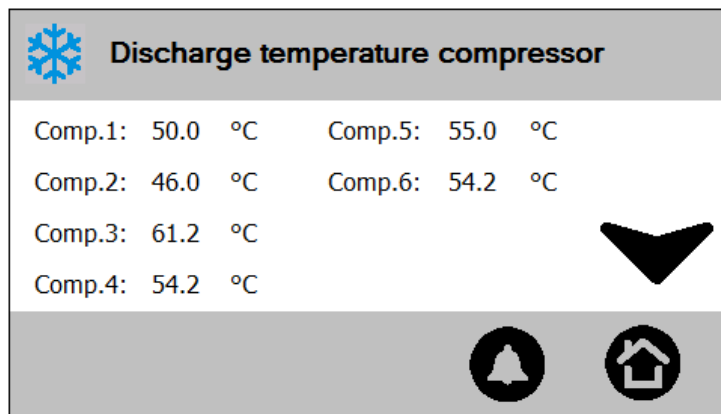

Press the  button can exit current screen.

6.8.16 Domestic Hot Water (Sanitary Water)

If AH01 = 0 (Auxiliary heating is disabled), the icon for domestic hot water is shown as picture below.

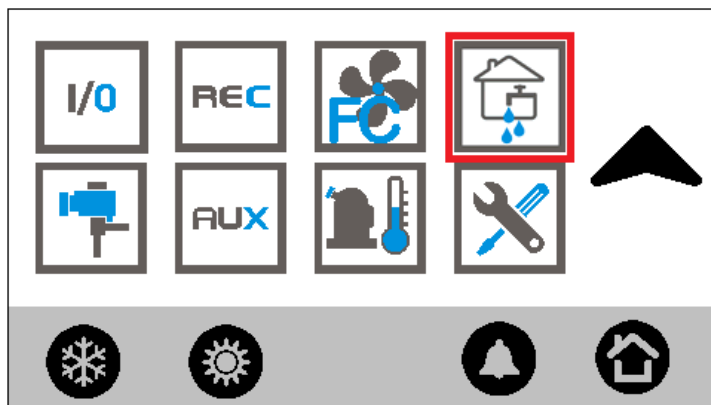

In sanitary water screen, relevant probes value and output status will display.

The sanitary water set point is editable.

Press  button for 1 second can enable/disable the sanitary water function.

The sanitary water function status can be:

- DIS disabled by parameter setting
- Dis by key disabled by keyboard
- Not requested not needed
- Doing dF defrost in progress
- Changing state requested but not start yet, in inversion valve changing phase.
- ON activated

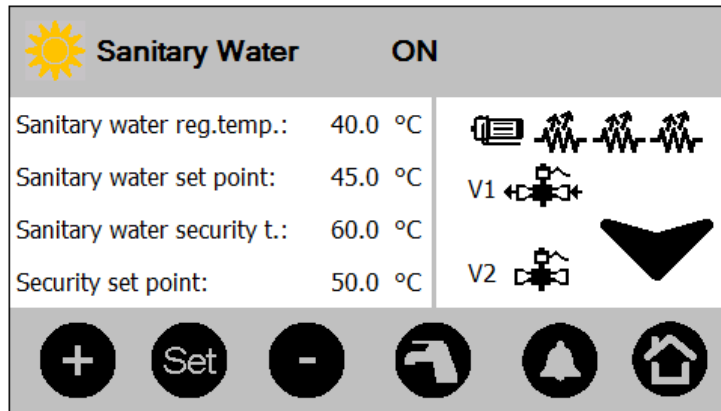

In Antilegionella cycle screen, relevant probes value, status and count down time will display. The Antilegionella set point and the activate time is editable.

The antilegionella function status can be:

- DIS disabled by parameter setting
- Not active deactive
- Running active

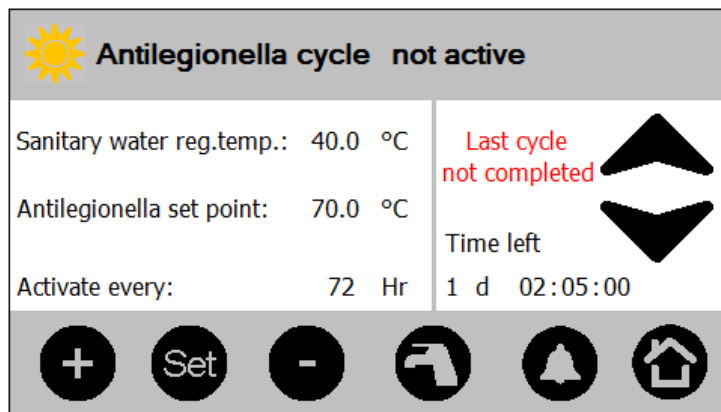



In Solar panel screen, relevant probes value and output status will display.

The Solar panel set point is editable.

The solar panel working status can be:

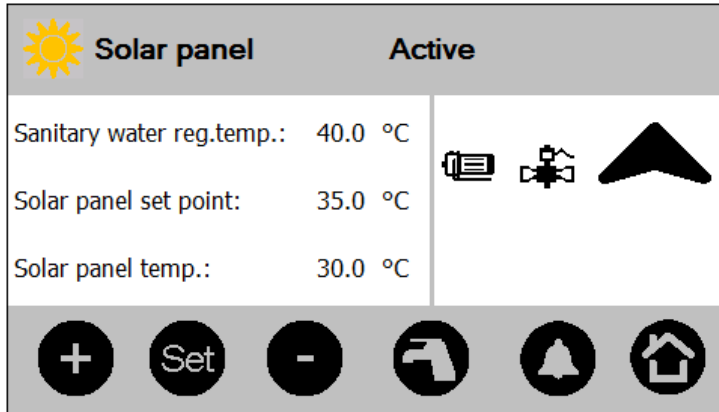
- Not active
- Active



Press the  button can exit current screen.

6.8.17 Auxiliary Heating

If AH01 > 0 (Auxiliary heating is enabled), the icon for auxiliary heating is shown as picture below.



In auxiliary heating screen, set points and output status are displayed.

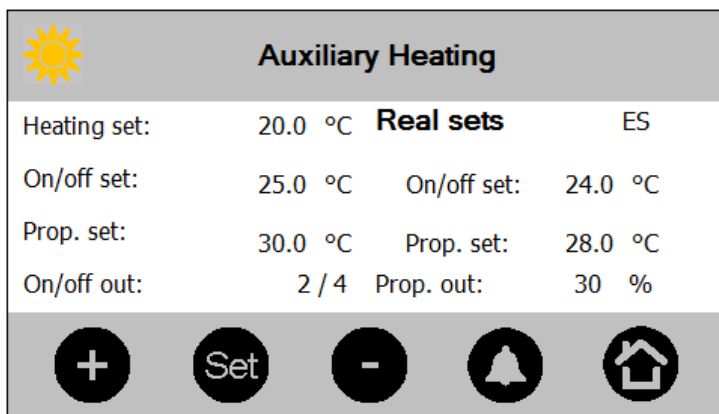

Press the  button can exit current screen.

6.8.18 Control Panel

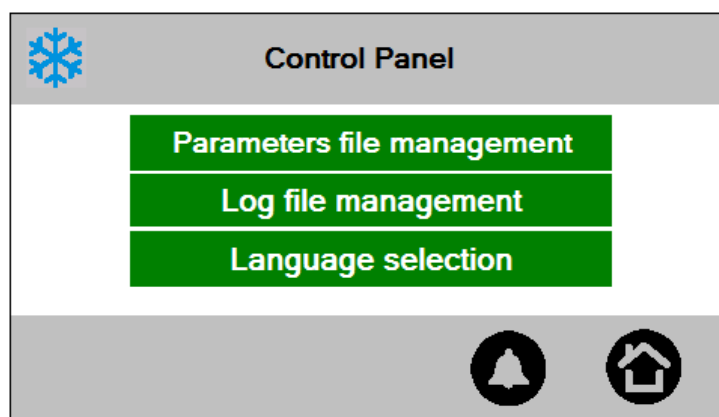
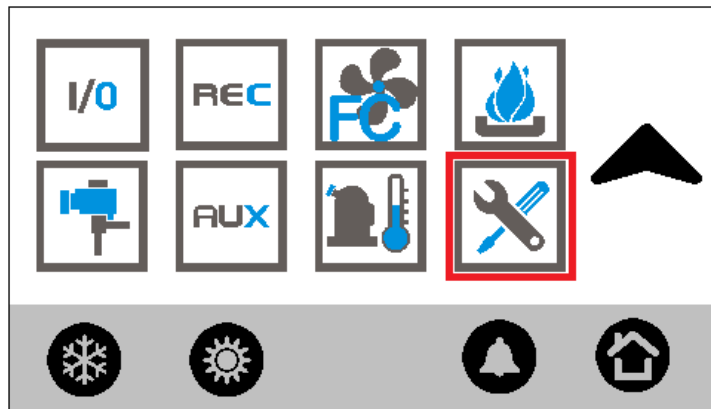

If user entered into SERVICE menu with 1st level or 2nd level, he needs to input the 3rd level password to enter in the control panel screen. See graph below:

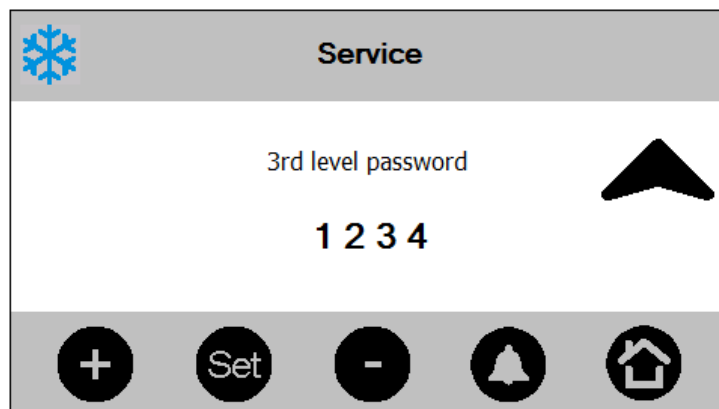

On the contrary, if user entered into SERVICE menu with 3rd level, no password is needed for control panel menu anymore.

The possible options in this menu are:

- Parameters file management: Load last saved parameters or load default parameters.
- Log file management:
Export log files to USB disk.
- Language selection: Italian → English → Italian
- Parameters file management:
Position the cursor on the element with UP and DOWN key, press ENTER, the parameters value will be

loaded from configuration file.

There are 2 files available, one for latest saved parameters and another for default parameters.

The 3rd line “Save as default parameters” means copy latest saved parameters to default parameters configuration file.

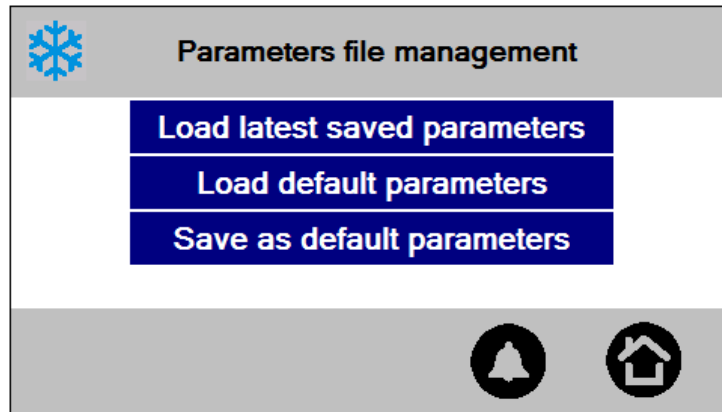

- Log file management:

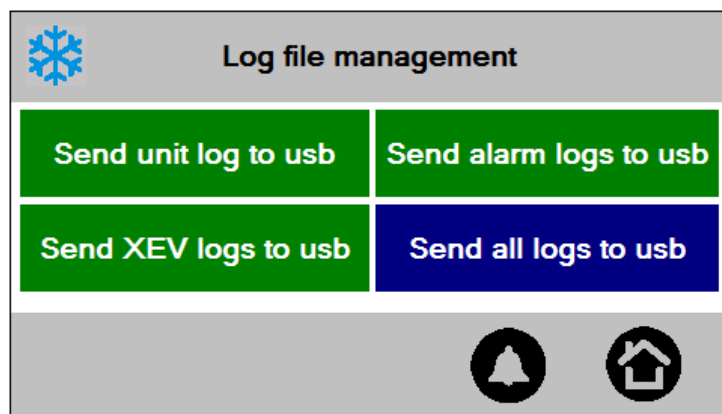

Plug the USB disk in iPro, send command from this screen, the log file will be export to the USB disk.

The log file path is: USB ROOT:\ipro\IP address of the ipro

One example for unit log: F:\ipro\10.161.92.79\log\Unit_20130221.txt

Unit log file (Record every 100 PLC cycles):

```
1 Counter,Date,Status,Set,Regulation probe,steps required,steps provided,unloading,water pumps,average cycle time,overcycles
2 130117101213,HP,100,-61,3,3,FALSE,FALSE,99,42,
3 130117101226,HP,100,-61,3,3,FALSE,FALSE,100,37,
4 130117101238,HP,100,-61,3,3,FALSE,FALSE,94,38,
5 130117101251,HP,100,-61,3,3,FALSE,FALSE,94,36,
```

Alarms log file (including alarms_a, alarms_b, alarms_c):

- alarms_a = unit alarm
- alarms_b = circuit alarm
- alarms_c = compressor alarm

alarms_a log file:

```
1 Counter,Date,Alarm description,Alarm status,Events in last hour
2 121115150206,AEM3-IPEX 3 not connected,START,18
3 121115150206,AEM4-IPEX 4 not connected,START,18
4 121115150307,AP22-Failure on probe 5 exp. 2,START,19
5 121115150307,AP5 -Failure on probe 5,START,19
```

Xev log file (including xev11, xev12, xev21, xev22):

Record every 10 seconds if XEV20D is available.

```
1 Counter,Date,Suction pressure,Saturation temperature,Suction temperature,Superheating,Steps
2 130130121005,60,45,125,70,500
3 130130121015,59,44,121,68,496
4 130130121025,57,45,123,63,492
5 130130121035,56,44,122,61,488
```

- Language selection:



Press the  button can exit current screen.

7. LED INTERFACE

Using the LED keyboard, it is possible to monitor and modify the status of the unit.



Meaning of each LED:

- to indicate that the measurement unit of displayed probe/parameter is ° C.
- to indicate that the measurement unit of displayed probe/parameter is °F.
- to indicate that RTC is displaying now.
- to indicate that the measurement unit of displayed probe/parameter is bar.
- to indicate the measurement unit of displayed probe/parameter is PSI.
- ... to indicate if compressors 1 to 6 is working.
- on to indicate that the defrost cycle is in progress, flashing during the countdown.
- to indicate that the condenser fans are working.
- to indicate that the water pump/supply fan is working.
- to indicate that the anti-freeze/auxiliary heaters are active.
- to indicate that the auxiliary outputs are active.
- flashing to indicate that an alarm is active.
- to indicate that the probe display now is belongs to circuit 1.
- to indicate that the probe display now is belongs to circuit 2.
- flashing to indicate that the AEFL or ACFL or AHFL or APFL alarm is active
- If SP08 = 0, to indicate that in cooling mode. If SP08 = 1, to indicate that in heat pump mode.
- If SP08 = 0, to indicate that in heat pump mode. If SP08 = 1, to indicate that in chiller mode.
- to indicate that the unit is working within the energy saving period or that the dynamic set-point is active.
- to indicate that menu screen is displaying.

Here below the LED interface structure graph.

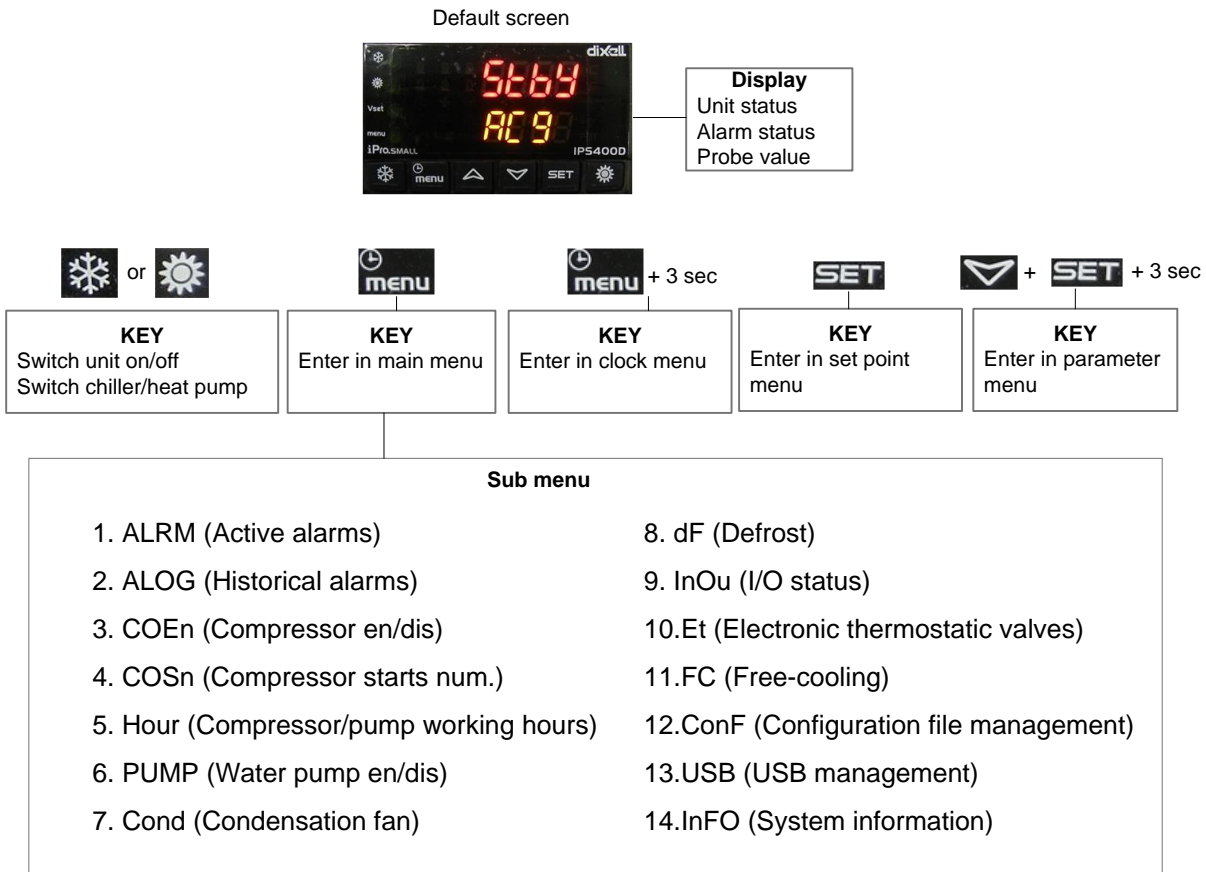

7.1 THE DEFAULT SCREEN





In this screen, unit status, alarms information and some appointed probes' value will be displayed in two lines.

Default view in different situations:

	Unit switch off by DI or RTC	Unit stand-by	Unit on
First line	OFF	if DP11 = 0: Stby if DP11 = 2: OFF if DP11 = 1: Item selected by DP09	Selected by DP09
Second line	Active alarms	if DP11 = 0: Active alarms if DP11 = 2: Active alarms if DP11 = 1: Scrolled display item	Scrolled display item selected by DP10 and active alarms

		selected by DP10 and active alarms	
--	--	------------------------------------	--

In the second line, all the active alarms will display in sequence as a cycle. Each alarm keeps visible for one second.

Press key  or  is possible to see some other probe value if it is configured.

First line: display probe value









Second line: display probe name and active alarms

The available probes are:

Index	Display as	AI description	AI type
1	EIn	Evaporator common input NTC temperature probe	7
2	Out1	Evaporator 1 output NTC temperature probe	8
3	Out2	Evaporator 2 output NTC temperature probe	9
4	EOut	Evaporator common outlet NTC temperature probe	10
5	CIn	Condenser hot water common input NTC temperature probe	11
6	CIn1	Circuit 1 condenser hot water input NTC temperature probe	12
7	CIn2	Circuit 2 condenser hot water input NTC temperature probe	13
8	COu1	Circuit 1 condenser hot water output NTC temperature probe	14
9	COu2	Circuit 2 condenser hot water output NTC temperature probe	15
10	COuT	Condenser hot water common output NTC temperature probe	16
11	FCIn	System water inlet NTC temperature probe (free-cooling)	17
12	FCEt	External air / condenser water (free cooling) temperature NTC temperature probe	18
13	Et	External air temp / dynamic set point / auxiliary heating / change over NTC temperature probe	19
14	SAn1	Domestic water temperature regulation NTC temperature probe (num. 1)	24
15	SAn2	Domestic water temperature safety NTC temperature probe (num. 2)	25
16		Supply temperature NTC temperature probe	26
17	SoLE	Solar panel NTC temperature probe	27
18	dSet	Dynamic set-point 4÷20 mA probe	36
19	Cdt1	Circuit 1 condensation probe (NTC temperature)	28
20	Cdt2	Circuit 2 condensation probe (NTC temperature)	29
21	CdP1	Circuit 1 condensation probe (pressure 4÷20 mA / ratiometric 0÷ 5Volt)	30
22	CdP2	Circuit 2 condensation probe (pressure 4÷20 mA / ratiometric 0÷ 5Volt)	31
23	LP1	Circuit 1 evaporation pressure probe (pressure 4÷20 mA / ratiometric 0÷ 5Volt)	32
24	LP2	Circuit 2 evaporation pressure probe (pressure 4÷20 mA / ratiometric 0÷ 5Volt)	33
25	dEF1	Circuit nº 1 combined defrost NTC temperature probe	20

26	dEF2	Circuit n° 2 combined defrost NTC temperature probe	21
27	uSt1	Auxiliary output 1 NTC temperature probe	22
28	uSt2	Auxiliary output 2 NTC temperature probe	23
29	uSP1	Circuit 1 auxiliary output pressure probe (pressure 4÷20 mA / ratiometric 0÷ 5Volt)	34
30	uSP2	Circuit 2 auxiliary output pressure probe (pressure 4÷20 mA / ratiometric 0÷ 5Volt)	35

KEYS INTRODUCTION

-  If SP08 = 0, press this key to switch on/off the unit to work in chiller mode.
If SP08 = 1, press this key to switch on/off the unit to work in heat pump mode.
-  Press to enter in main menu screen. Keep press for 3 seconds to adjust clock.
-  Press to switch probe being shown
-  Press to switch probe being shown
-  Press to check set point
-  If SP08 = 0, press this key to switch on/off the unit to work in heat pump mode.
If SP08 = 1, press this key to switch on/off the unit to work in chiller mode.
-  +  Press these 2 keys together for 3 seconds to check parameters.

7.2 HOW TO CHANGE SET POINT

Press and release key  in the default screen can enter into set point screen.



First line: display set point value

Second line: display set point type. It can be:

SEtC -> set point in chiller mode (ST01)



SEtH -> set point in heat pump mode (ST04)



SEtd -> real set point when dynamic set point is active

SEtS -> real set point when energy saving is active





SEtr -> real set point when both dynamic set point and energy saving are active

Press key  can exit and jump back to the default screen.



When unit is switch off or stand-by, both chiller set point and heat pump set point are visible. Press key  or  can change over.

When unit is switch on, only the set point corresponding to current work mode is visible. If dynamic set point or energy saving is active, Press key  or  can switch to see the real set point: SEtd, SEtS or SEtr.

CHANGE SET POINT

If SEtC or SEtH is displaying, press key  for 3 seconds can edit the set point value. At this time, the first line start to blink. Press key  or  to increase or decrease the set point value, then press key  to confirm modification and jump back to the default screen.

7.3 HOW TO ADJUST CLOCK

Press key   for 3 seconds in the default screen can enter into clock adjusting screen.



First line: display clock value

Second line: display clock type. It can be:



Hour -> current hour

Min -> current minute





dAy -> current day

MntH -> current month

yEAr -> current year

Press key   can exit and jump back to the default screen.

Press key  or  can switch display items.

Press key  can edit the selected clock value. At this time, the first line start to blink. Press key  or  to increase or decrease the clock value, then press key  to confirm the modification.

7.4 HOW TO PROGRAM PARAMETERS

Press keys  + **SET** together for 3 seconds in the default screen can enter into parameters programming screen.



Press key  **menu** can back to default screen.

In this screen, it is possible to select user level. There are 3 levels in all: Level 1(Pr1), Level 2(Pr2) and Level 3(Pr3). To enter Level 2 or Level 3 parameters screen, the relevant password must be input. For Level 1, no password needed.





	Level 1	Level 2	Level 3
First line	Entr	PASS	PASS
Second line	Pr1	Pr2	Pr3

HOW TO INPUT PASSWORD

Take Pr2 for example:



Step1: Press key **SET**. "0" will display in the first line.

Step2: Press keys  or  to input password. Inputted value is shown in the first line. Press key  or  can fast increase/decrease the input value by 100 every time.

Step3: Press key **SET**. If inputted password is not correct, it will change back to "0". If correct, enter in parameter groups screen. "St" will display in the first line.



Press key  **menu** can back to previous screen.



HOW TO CHECK AND CHANGE PARAMETER VALUE

In parameter groups screen:

Step1: Press key  or  to select parameter groups.

Step2: Press key **SET**, the first visible parameter of this group will display with name in the second line and value in the first line.

Step3: Press key  or  can switch to other parameters of this group.

Step4: Press key **SET** for 3 seconds can edit the selected parameter's value. At this time, the first line start to blink. Press key  or  to increase or decrease the value, then press key **SET** to confirm.

Press key  **menu** can back to previous screen.

For parameter group IO, there is a little difference. It is divided into 4 sub groups: Pb, DI, rL and AO. IO parameters are available in these 4 sub group screens.

Some parameters are preset with high protection level. They are only visible or editable with higher user level. If the parameter is not editable, "." LED in the second line will be lighten as an indication. See picture below:





7.5 MAIN MENU SCREEN

Press key  **menu** in the default screen can enter into main menu screen.

To exit this screen, press key  **menu** again.





Press key  or  can scan all available sub-menus. Here below the table for summary. The sub-menu name is display in the second line.

After selection of interested sub-menu, press key **SET** can enter in the sub-menu.

Index	Sub-menu name	Visible condition	Description
1	ALRM	√	Active alarms
2	ALOG	√	Historical alarms
3	COEn	√	Compressor enable/disable
4	COSn	√	Compressor starts number
5	Hour	√	Compressor/pump working hours
6	PUMP	PA01 > 0 or PA17 > 0	Water pump enable/disable
7	Cond	FA01 > 0	Condensation fan
8	dF	dF01 > 0 and unit switch on in heat pump mode	Defrost
9	InOu	√	I/O status
10	Et	ET09 or ET10 or ET11 or ET12 > 0	Electronic thermostatic valves
11	FC	FC01 > 0	Free-cooling
12	ConF	√	Configuration file management
13	USB	√	USB management
14	InFO	√	System information

Note: √ means always visible.

7.5.1 Active Alarms Sub-Menu

Press key  or  in main menu screen till the second line display "ALRM". Then press key  can enter in active alarms sub-menu.

In this menu, it is possible to check and reset active alarms.



First line: alarm status. It can be:
no: active now, not resettable
rSt: resettable
PASS: resettable with password

Second line: alarm code (see chapter ALARMS for reference)

Press key  or  can scan all active alarms.

To exit this screen, press key .





If the first line is showing "rSt", press key  can reset selected alarm.

If the first line is showing "PASS", press key  can enter in password input screen.



HOW TO INPUT PASSWORD



Step1: Press key . "0" will display in the first line.

Step2: Press keys  or  to input password. Inputted value is shown in the first line. Press key  or  can fast increase/decrease the input value by 100 every time.

Step3: Press key . If inputted password is not correct, it will change back to "0". If correct, selected alarm is resettled and jumps back to active alarms screen.

Press key  can back to previous screen.

7.5.2 Historical Alarms Sub-Menu

Press key  or  in main menu screen till the second line display "ALOG". Then press key  can enter in historical alarms sub-menu.

In this sub-menu, it is possible to view and clear historical alarms log.



First line: alarm index. For example: n1, n2, n3...



Second line: alarm code (see chapter ALARMS for reference)

If no alarms record, it will display "- - -" in both first line and second line.

To exit this screen, press key .

Press key  or  can scan all historical alarms.

Press key  can enter to see the detailed information of selected alarm log. Including system status and alarm start time/date. The system status can be: CHIL, HEAt, StbY, ROFF, COFF and FAN.

Press key  or  can switch the display items. See picture below:





For back to previous screen, press key .





HOW TO CLEAR ALARMS LOG

Step 1: Press key  or  till "PASS" display in first line and "Arst" display in second line.



Step 2: Press key , enter in password input screen. "0" will display in the first line.

Step 3: Press keys  or  to input password. Inputted value is shown in the first line. Press key  or  can fast increase/decrease the input value by 100 every time.

Step3: Press key . If inputted password is not correct, it will change back to "0". If correct, alarms log is cancelled.

Press key  can back to previous screen.

7.5.3 Compressor Enable/Disable Sub-Menu

Press key  or  in main menu screen till the second line display "COEn". Then press key  can enter in compressor enable/disable sub-menu.



In this sub-menu, it is possible to enable/disable compressors.



First line: Compressor status (En/diS)



Second line: Compressor index (CO1E, CO2E ... CO6E)

To exit this screen, press key .

Press key  or  can scan all configured compressors.

Press key  for 3 seconds can enable or disable the selected compressor.

7.5.4 Compressor Starts Number Sub-Menu

Press key  or  in main menu screen till the second line display “COSn”. Then press key  can enter in compressor starts number sub-menu.



In this sub-menu, it is possible to view and reset the number of compressors starts.



First line: Compressor starts number (unit in 10 times)



Second line: Configured compressor index (**CO1S, CO2S ... CO6S**)

To exit this screen, press key .

Press key  or  can scan all configured compressors.

Press key  for 3 seconds can reset the starts number of selected compressor.

7.5.5 Compressor/Water Pump Working Hours Sub-Menu

Press key  or  in main menu screen till the second line display “Hour”. Then press key  can enter in the sub-menu.

In this sub-menu, it is possible to view and reset compressor/water pump working hours.



First line: Compressor/pump working hours (unit in 10 hours)



Second line: Configured compressor/pump index . Including:

compressor: **CO1H ... CO6H**

evaporator pump: **EP1H, EP2H**



condenser pump: **CP1H, CP2H**

To exit this screen, press key .

Press key  or  can scan all configured compressors and pumps.

Press key  for 3 seconds can reset the working hours of selected compressor/pump.

7.5.6 Water Pump Enable/Disable Sub-Menu

Press key  or  in main menu screen till the second line display “PUMP”. Then press key  can enter in the sub-menu.

In this sub-menu, it is possible to enable/disable water pump (and supply fan).



Only visible when: PA01 > 0 or PA17 > 0



First line: Water pump status (**En/diS**)



Second line: Water pump index (**PE1E, PE2E, PC1E, PC2E**)

To exit this screen, press key .

Press key  or  can scan all configured water pumps.

Press key  for 3 seconds can enable or disable the selected water pump.

7.5.7 Condensation Fan Sub-Menu

Press key  or  in main menu screen till the second line display “Cond”. Then press key  can enter in the sub-menu.

In this sub-menu, it is possible to see condensation fans working status.

Only visible when: FA01 > 0





First line: Condensation fan output value.



(Proportional regulation: 0%-100%. ON/OFF regulation: 0-4 step)

Second line: Condensation fan index (**Cnd1, Cnd2**)

To exit this screen, press key .

Only when 2 circuits are configured and FA06=1, both Cnd1 and Cnd2 are visible. Press key  or  can switch to see condensation fan for circuit 1 or circuit 2.

7.5.8 Defrost Sub-Menu

Press key  or  in main menu screen till the second line display “dF”. Then press key  can enter in the sub-menu.

In this sub-menu, it is possible to see defrost working status.



Only visible when: dF01 > 0 and unit switch on in heat pump mode



First line: Defrost index(dF1, dF2)



Second line: Time before selected circuit starts defrost. In the format: **Minutes: Seconds**

To exit this screen, press key .

Only when 2 circuits are configured, both dF1 and dF2 are visible. Press key  or  can switch to see defrost for circuit 1 or circuit 2.

Press key  for 3 seconds can start manual defrost.

7.5.9 I/O Status Sub-Menu

Press key  or  in main menu screen till the second line display “InOu”. Then press key  can enter in the sub-menu.



In this sub-menu, it is possible to see inputs and outputs status.



First line: nothing

Second line: I/O type (**Pb, di, rL, Pout**)

To exit this screen, press key .

Press key  or  to select the I/O type. Then press key  to see it's information.

PROBE(Pb)



DIGITAL INPUT (di)





RELAY (rL)



ANALOG OUTPUT (Pout)



7.5.10 Electronic Thermostatic Valves Sub-Menu

Press key  or  in main menu screen till the second line display “Et”. Then press key  can enter in the sub-menu.

In this sub-menu, it is possible to see electronic thermostatic valves status.

This menu only visible when ET09 or ET10 or ET11 or ET12 > 0



First line: Values

Second line: Descriptions (**Open**, **SH**, **Tasp**, **Pasp**):



Open: valve open percent.

SH: super heat

Tasp: suction temperature



Pasp: suction pressure

To exit this screen, press key .

Press key  or  can scan all status of electronic thermostatic valve.

If 2 circuits are configured, press key  can switch to see another electronic thermostatic valve.

7.5.11 Free-Cooling Sub-Menu

Press key  or  in main menu screen till the second line display “FC”. Then press key  can enter in the sub-menu.

In this sub-menu, it is possible to see free-cooling working status.

This menu only visible when FC01 > 0





First line: Status/Values

Second line: Descriptions (depending on FA06, see table below:)



Index	FA06 = 0	FA06 > 0
1	FCEn Free-cooling enable/disable	FCEn Free-cooling enable/disable
2	FCSt Free-cooling ON/OFF	FCSt Free-cooling ON/OFF
3	FCin Water inlet temperature	FCin Water inlet temperature
4	FCtE External air temperature	FCtE External air temperature
5	FCFA Fan speed (proportional/step)	FCFA Circ 1 Circuit 1 fan speed (proportional/step)
6	First line: FCtE Second line: Time left before start/stop free-cooling	FCFA Circ 2 Circuit 2 fan speed (proportional/step)
7	FOut Free-cooling ON/OFF valve status	First line: FCtE Second line: Time left before start/stop free-cooling
8	(nothing)	FOut Free-cooling ON/OFF valve status

To exit this screen, press key .

Press key  or  can scan all status/values of free-cooling.

When **FCEn** is displaying, press key  for 3 seconds can enable/disable free-cooling.

7.5.12 Configuration File Management Sub-Menu

Press key  or  in main menu screen till the second line display "**ConF**". Then press key  can enter in the sub-menu.

In this sub-menu, it is possible to load parameters from configuration files.



First line: **LoAd**

Second line: File name (ActuAL: latest saved parameters. dEFAuLt: default parameters. **Copy**: copy last saved parameters as default parameters)

To exit this screen, press key .

Press key  or  can select configuration files between ActuAL and dEFAuLt.

Then press key  for 3 seconds, loading for selected configuration file will start. In the second line, it display the operation status. It can be:



In ProGrESS: loading in progress.

donE: loading done

FAIL: loading failed

After loading, press key  can back to previous screen.

7.5.13 USB Management Sub-Menu

Press key  or  in main menu screen till the second line display “USB”. Then press key  can enter in the sub-menu.

In this sub-menu, it is possible to export log files into USB key.

To exit this screen, press key .

NO USB KEY PRESENT



If no USB key is detected, the following message will display:

First line: **USb**

Second line: **Err**

USB KEY PRESENT

If USB key is detected, the following message will display:

First line: **SEnd**

Second line: log name (**Unit LoG, ALArM LoG, Et LoG, ALL**)

Unit LoG : Unit log file

ALArM LoG : Alarms log file (including alarms_a, alarms_b, alarms_c):

Et LoG : Xev log file (including xev11, xev12, xev21, xev22):

ALL: All the logs above

HOW TO EXPORT LOG FILES INTO USB KEY

Step 1: Plug the USB key in iPro. Enter in USB management sub-menu.

Step 2: Press key  or  select the log file needed.

Step 3: Press key  for 3 seconds, exporting will start.

The first line will display **USb**

The second line will show operation status:

In ProGrESS (During exporting),

donE (exporting done)



Error (exporting failed)

Step 4: Press key  back to previous screen.

Once exporting done, the log file is stored in path: USB ROOT:\ipro\IP address of the ipro

For example: F:\ipro\10.161.92.79\log\Unit_20130221.txt

7.5.14 System Information Sub-Menu

Press key  or  in main menu screen till the second line display "InFO". Then press key  can enter in the sub-menu.

In this sub-menu, it is possible to see some system information.

To exit this screen, press key .



First line: information

Second line: description (**APP, Adr, IP**)

APP: application name

Adr: Modbus address

IP: IP address

Press key  or  can scan all the information.

8. USE WIZMATE TO CONFIGURE PARAMETERS

Wizmate software allows the managing of the parameter map of DIXELL controllers.

8.1 HOW TO INSTALL WIZMATE

Insert the CD in the CD drive and click the "Wizmate.exe" file to start the guided process. press the "Next" button:



Accept the "Licence Agreement" and press the "Next" button to continue:

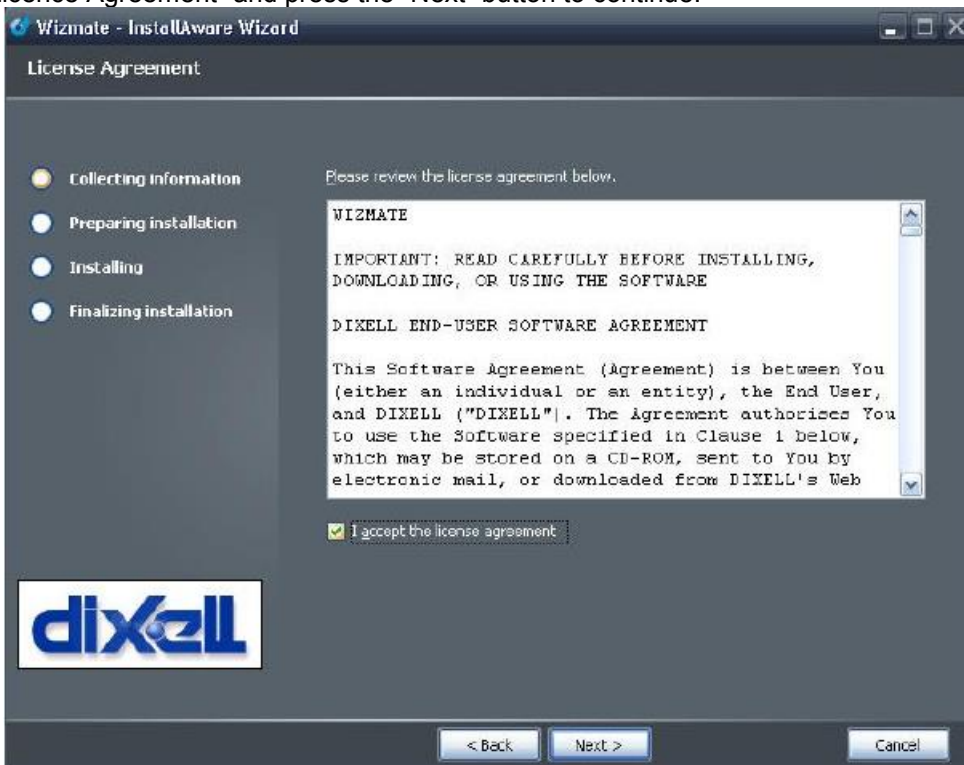

Enter "User name" and "Company name", then press the "Next" button to continue:

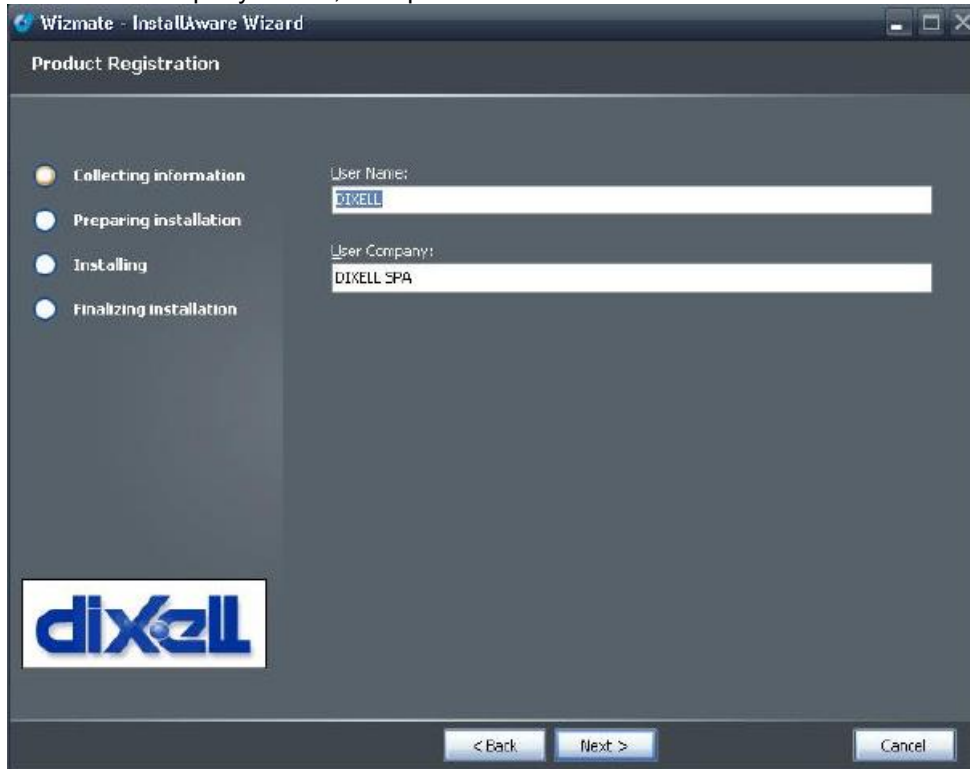

Select the path where you want to install the Wizmate; default path is "C:\Programs\Dixell\Wizmate"; press the "Next" button:

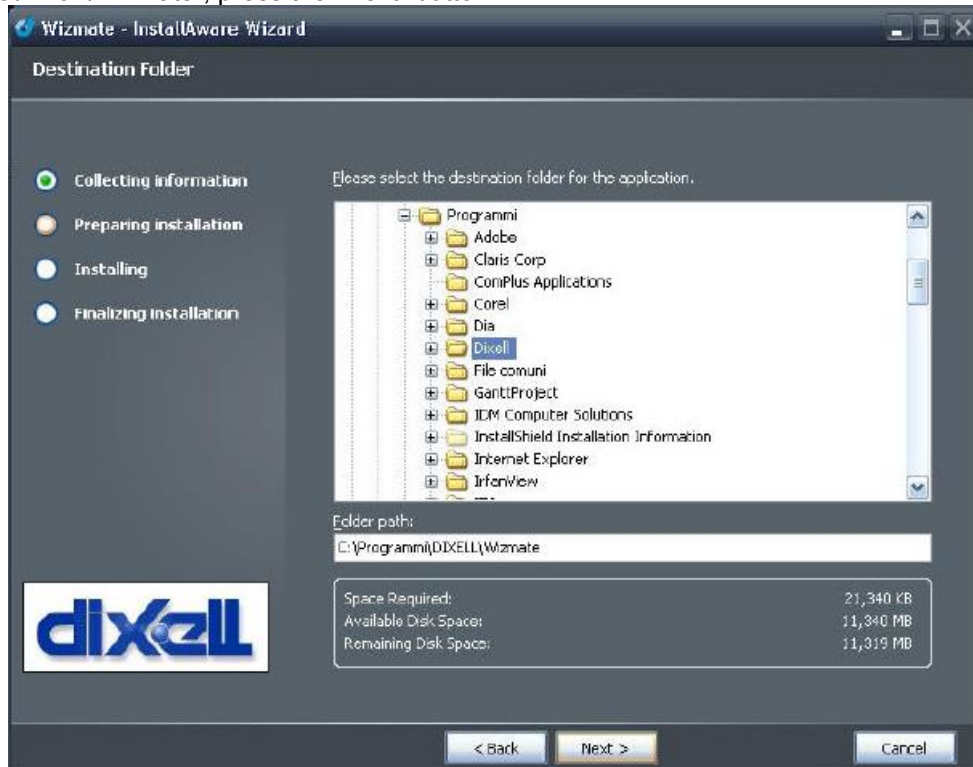

Press the "Next" button:

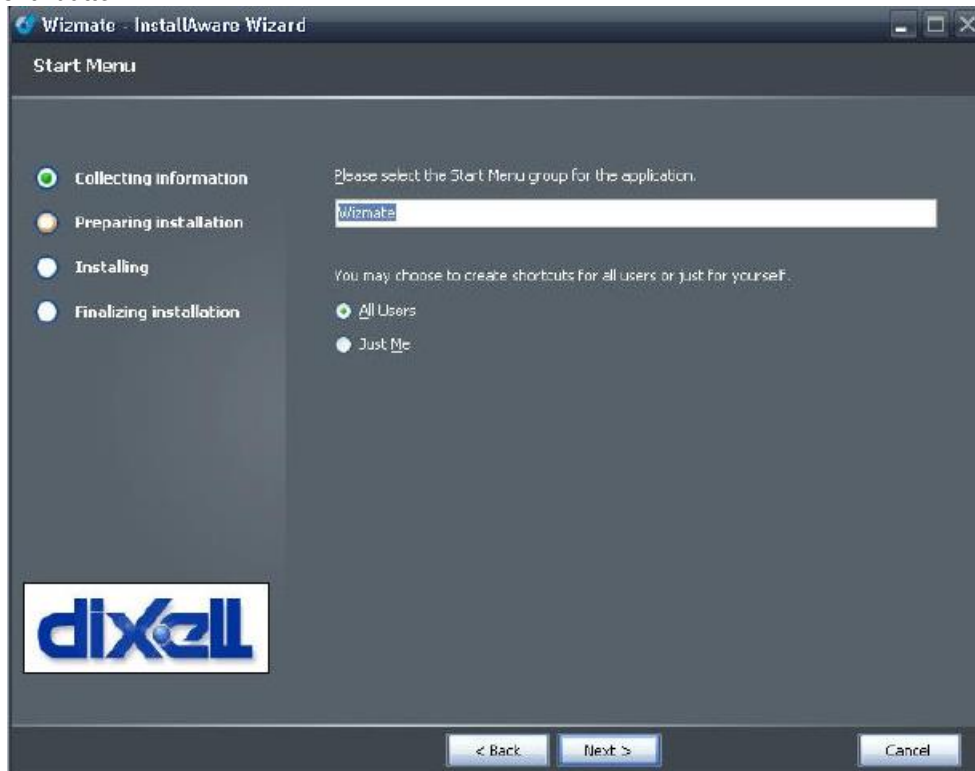

To finish the installation press "Next" button.



To exit the installation press “Finish” button.



8.2 LOGIN WIZMATE

After having installed Wizmate, two users are managed:

- User: can see only a small number of parameters (only Pr1 level of visibility); he cannot use all functions of the program (is not possible to create wizard and to create new users). The password is: “user”
- Administrator: can see all the parameters (Pr1, Pr2 and Pr3 level of visibility); the “Administrator” can use all the functions of the program. The password is: “admin”

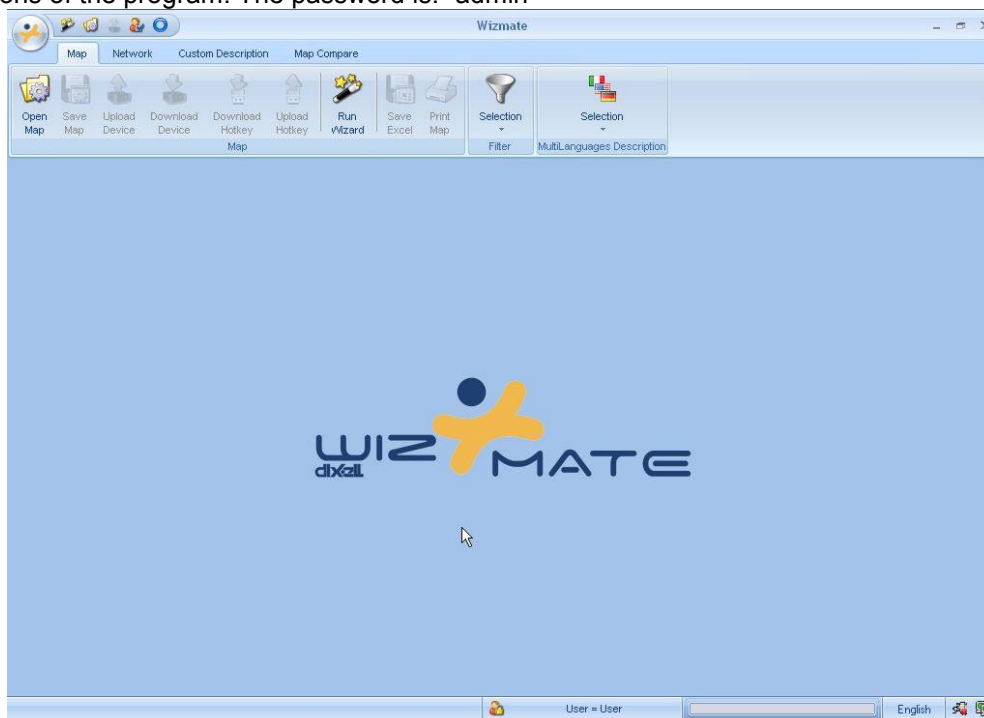

To access the program as “Administrator”, press the “Login” button:



or using the configuration menu (press the button) and select “Security” menu:

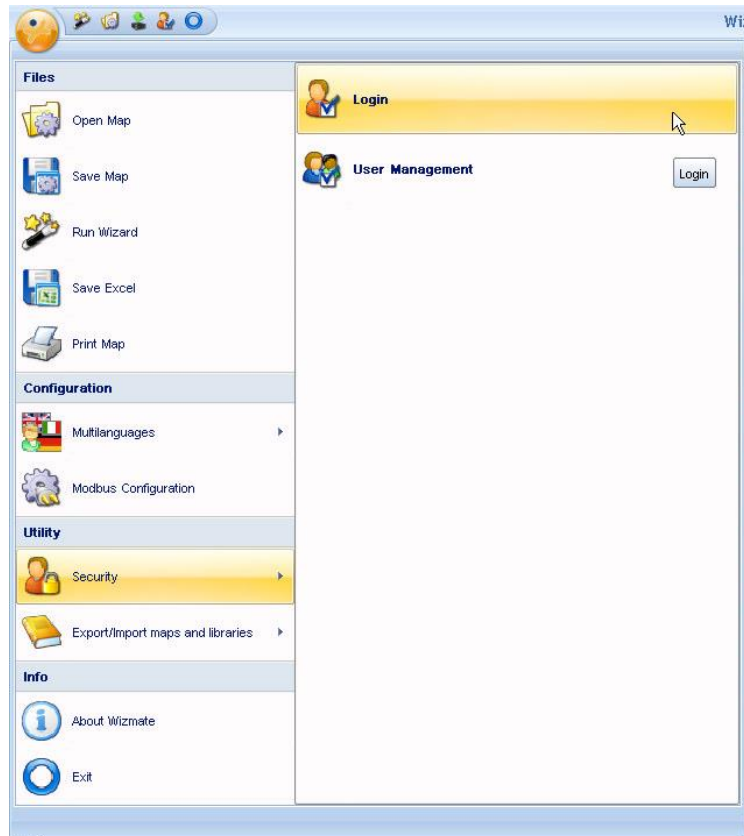

Enter the user name “Administrator” and password “admin”, then press “Login” button.



How to create a new user:

Only the “Administrator” user can create a new user.

Press  button, select “Security” and then “User management”:

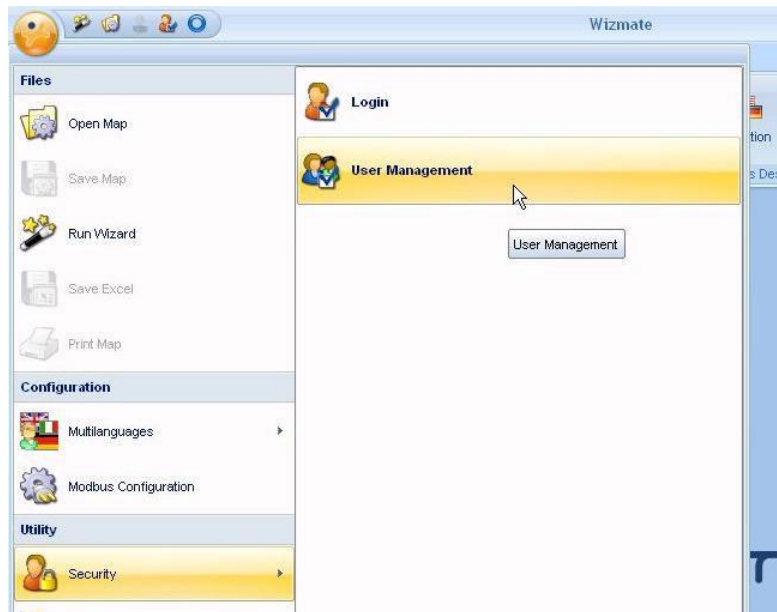

From the configuration menu, click “Security” _ “User Management” to display the following window:

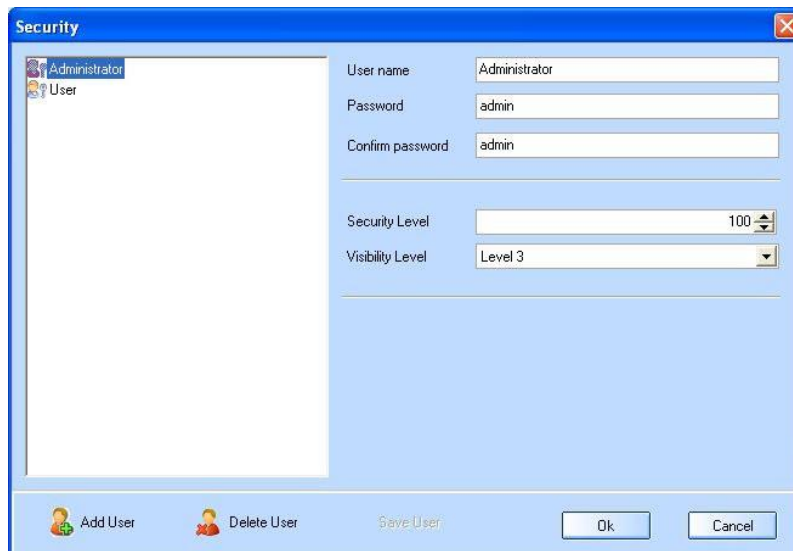

A new user can be entered clicking “Add user”:

- enter the user name
- enter the password
- confirm the password
- enter the security level:
 - level 5= “user” level (it is not possible to generate wizard);
 - level 100= “administrator” right (it is possible to generate wizard)
- enter the maximum level of visibility of the parameters
- to confirm, click the “Ok” button

8.3 WIZMATE CONFIGURATION

8.3.1 Configuration Menu



It is used to configure the language, the communication port (COM), etc.

8.3.2 Language Configuration

Press  button, select “Multilanguages” menu and choose the language:

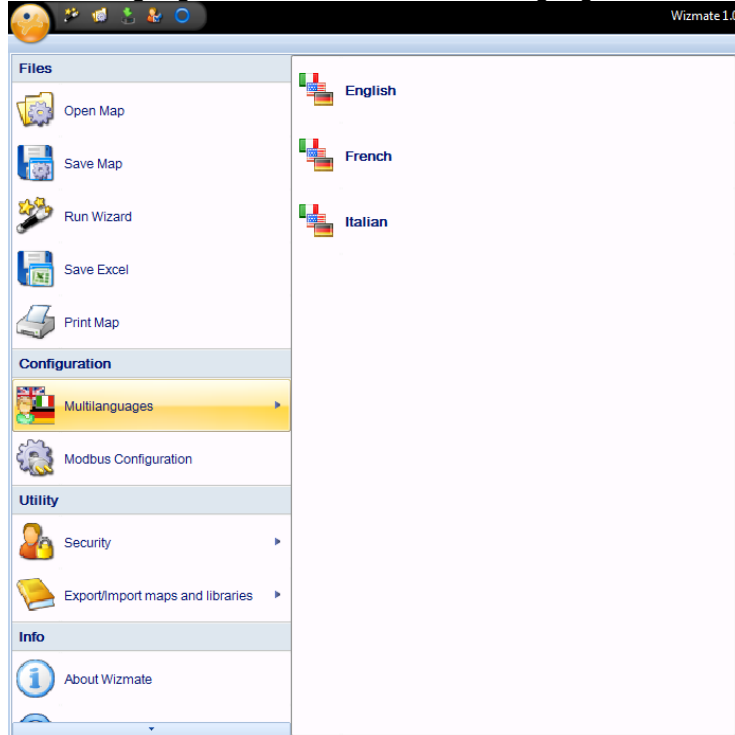

8.3.3 Import/Export Maps And Libraries

“Export/Import libraries and maps” allows the user to import the new library or import new maps. To import the maps or libraries contained in a *.WME file, select the command “Export/Import maps and libraries”, then select “Import libraries and maps”:

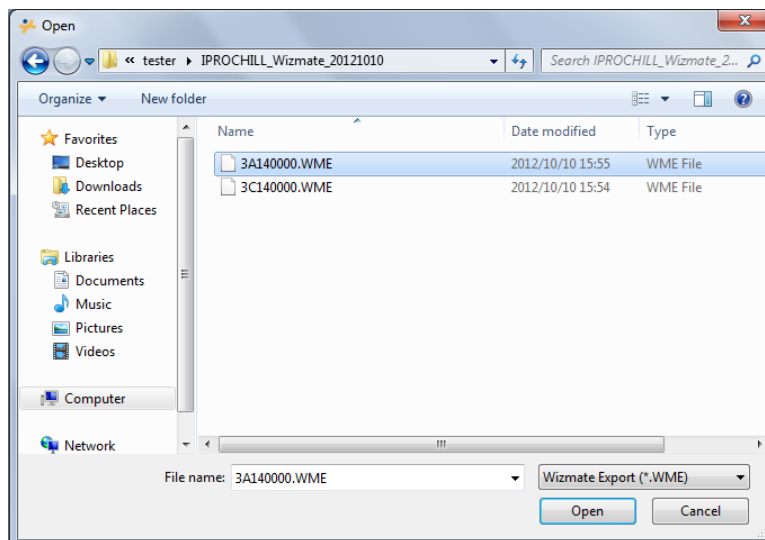
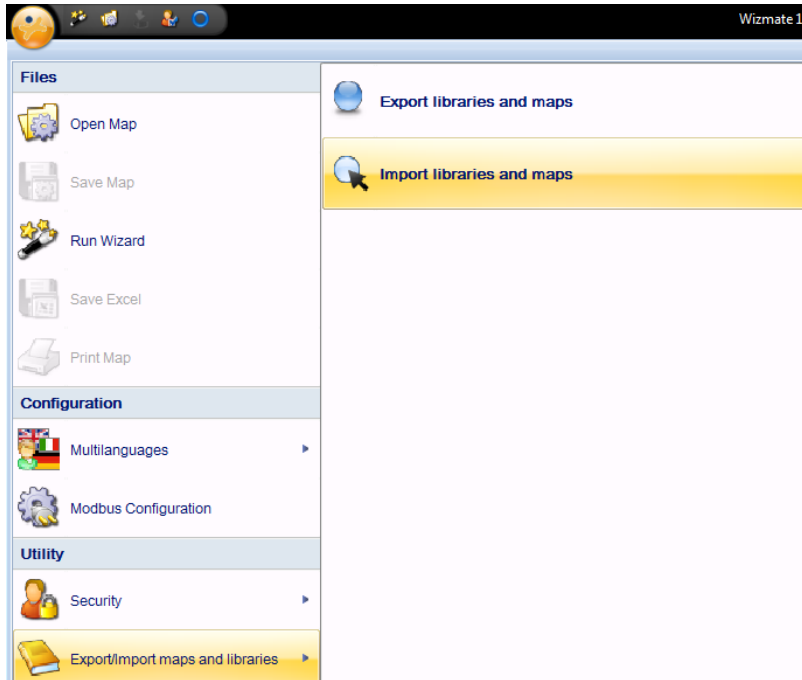

To export the maps or libraries, select the command “Export/Import maps and libraries”.

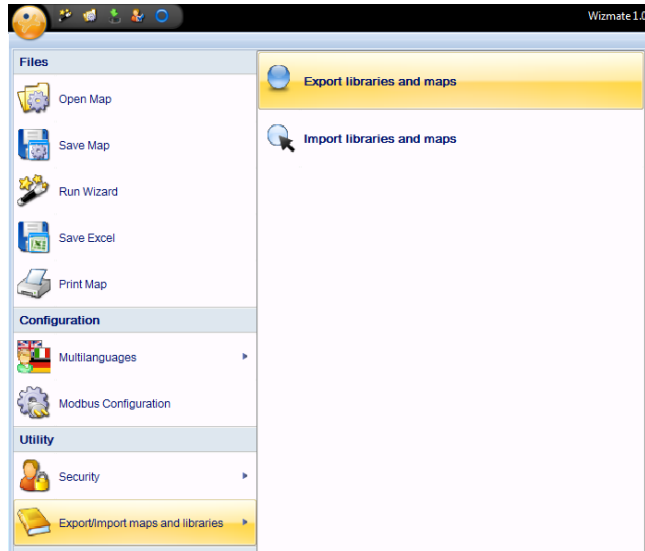

Then select "Export libraries and maps".

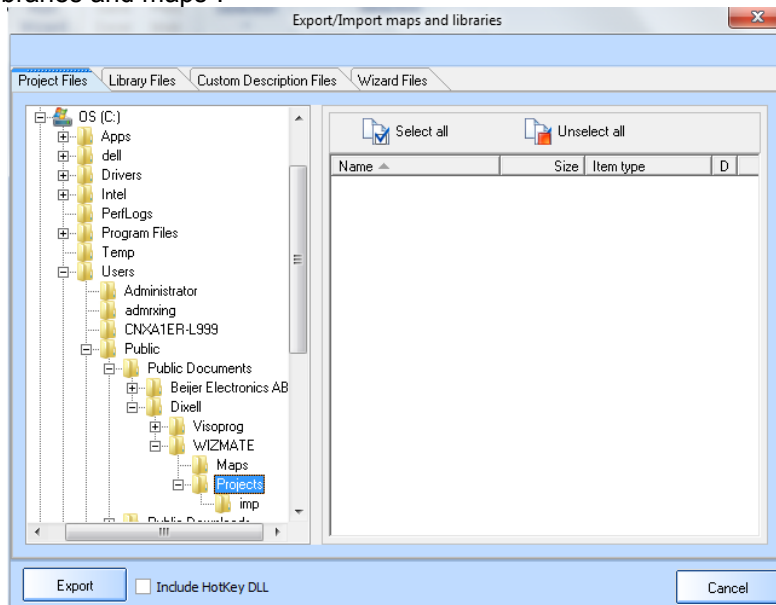

Search the maps to export, select them then press “Export” button:

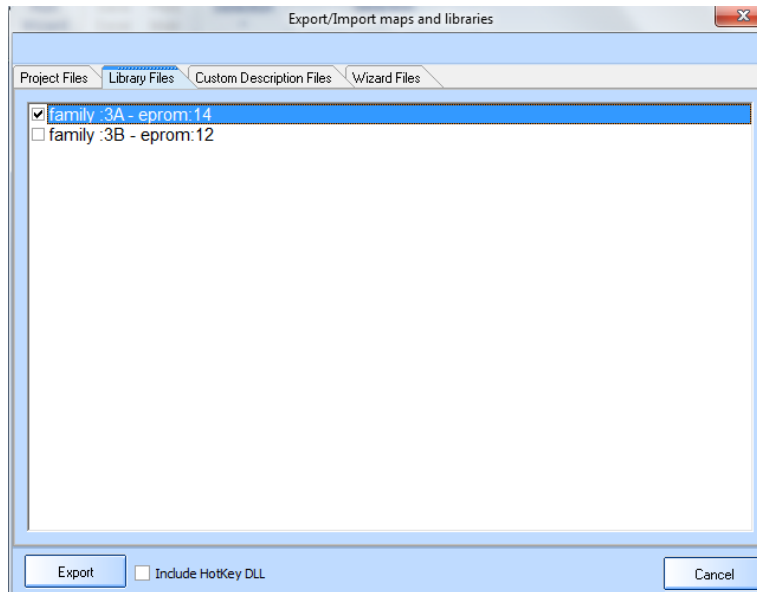

Select the path to save the file and enter the name of the file:

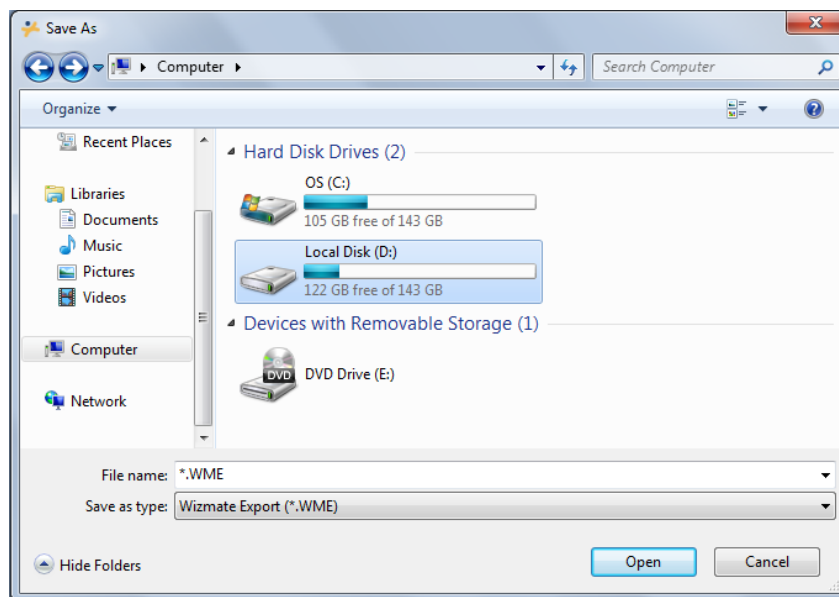

8.4 HOW TO USE WIZMATE

8.4.1 Scan For Device

Enter in “Network” menu, set “Start IP” and “Stop IP” according to your Ipro IP address.

Press button  , if the device is connected, it will display in the list.

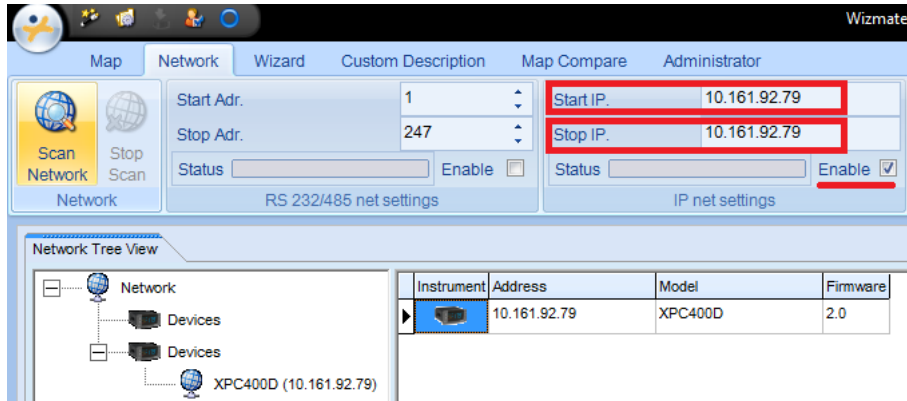

8.4.2 Read Parameters Value

Enter in menu “Map”, press button  , the parameters value will be read out from the ipro controller and display.

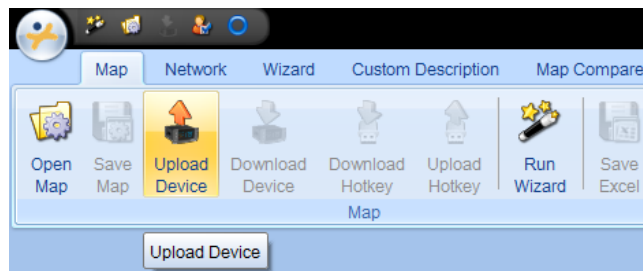

Group	Parameter	Description	Value		Vis. Level	Mod. level	Limit		Unit	Comment
			Edit	Original			Minimum	Maximum		
ST - Temperature	ST1	Chiller set point	30.0	30.0	1 - Pr1	1 - Pr1	0.0	30.0	°C	
ST - Temperature	ST2	Minimum chiller set point	0.0	0.0	3 - Pr3	3 - Pr3	-60.0	30.0	°C	
ST - Temperature	ST3	Maximum chiller set point	30.0	30.0	3 - Pr3	3 - Pr3	0.0	110.0	°C	
ST - Temperature	ST4	Heat pump set point	20.0	20.0	1 - Pr1	3 - Pr3	20.0	50.0	°C	
ST - Temperature	ST5	Heat pump minimum set point	20.0	20.0	3 - Pr3	3 - Pr3	-50.0	50.0	°C	
ST - Temperature	ST6	Heat pump maximum set point	50.0	50.0	3 - Pr3	3 - Pr3	20.0	110.0	°C	
ST - Temperature	ST7	Intervention band regulation steps in chiller	16.0	16.0	3 - Pr3	3 - Pr3	0.1	25.0	°C	
ST - Temperature	ST8	Intervention band regulation steps in heat p	10.0	10.0	3 - Pr3	3 - Pr3	0.1	25.0	°C	
ST - Temperature	ST9	Chiller temperature control probe	1 - Evapor	1 - Evapor	3 - Pr3	3 - Pr3				
ST - Temperature	ST10	Heat pump temperature control probe	0 - evapor	0 - evapor	3 - Pr3	3 - Pr3				
ST - Temperature	ST11	Defines the type of temperature control	0 - Propor	0 - Propor	3 - Pr3	3 - Pr3				
ST - Temperature	ST12	Defines the temperature control logic	0 - Of max	0 - Of max	3 - Pr3	3 - Pr3				
ST - Temperature	ST13	Circuit 2 chiller set point	0.0	0.0	3 - Pr3	3 - Pr3	0.0	0.0	°C	
ST - Temperature	ST14	Circuit 2 chiller minimum set point	0.0	0.0	3 - Pr3	3 - Pr3	-60.0	0.0	°C	
ST - Temperature	ST15	Circuit 2 chiller maximum set point	0.0	0.0	3 - Pr3	3 - Pr3	0.0	110.0	°C	
ST - Temperature	ST16	Circuit 2 heat pump set point	0.0	0.0	3 - Pr3	3 - Pr3	0.0	0.0	°C	
ST - Temperature	ST17	Circuit 2 heat pump minimum set point	0.0	0.0	3 - Pr3	3 - Pr3	-60.0	0.0	°C	
ST - Temperature	ST18	Circuit 2 heat pump maximum set point	0.0	0.0	3 - Pr3	3 - Pr3	0.0	110.0	°C	
ST - Temperature	ST19	Intervention band regulation steps of circuit	0.1	0.1	3 - Pr3	3 - Pr3	0.1	25.0	°C	

In this screen, it display parameters' group, name, description, value, visibility/changeability level, minimum/maximum limitation and measurement unit.

To facilitate using, it allows to select and display one single parameter group. Right click on the table, in the pop-out menu, chose "Group" and then select the interested group.

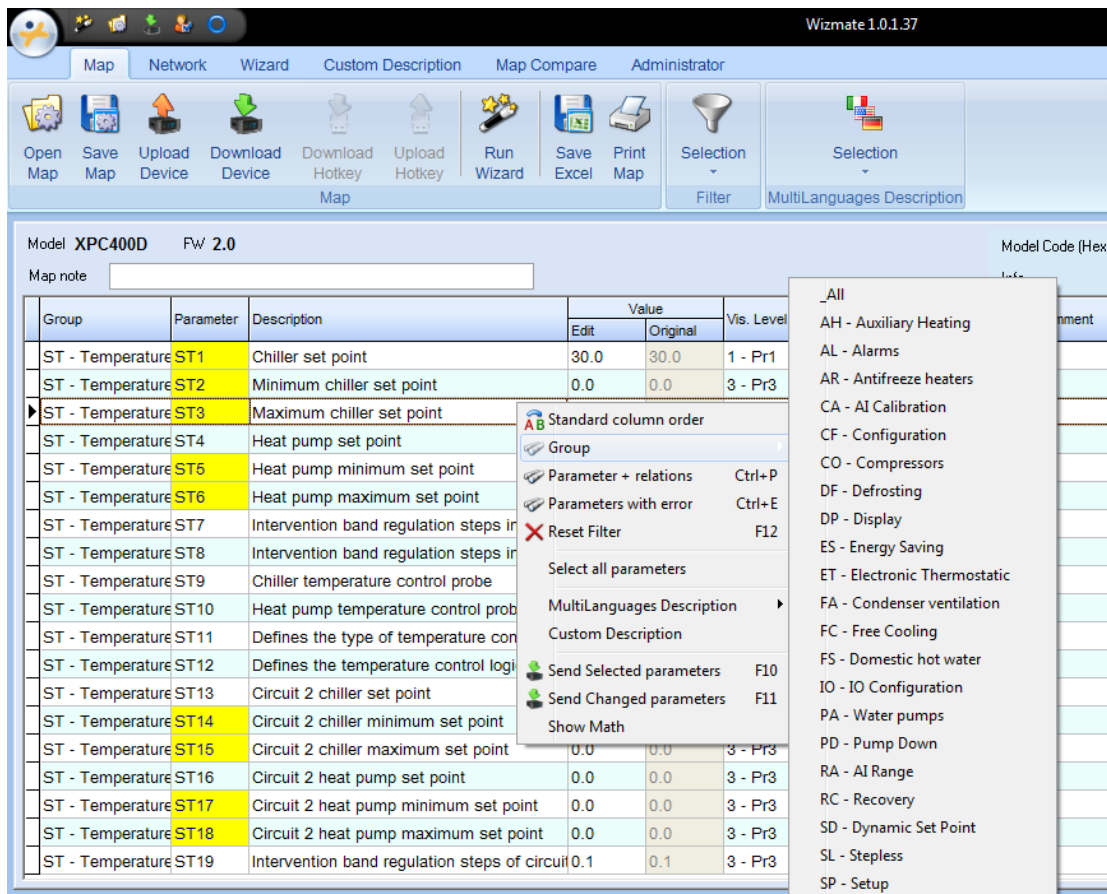

This function can also be done by click button  .

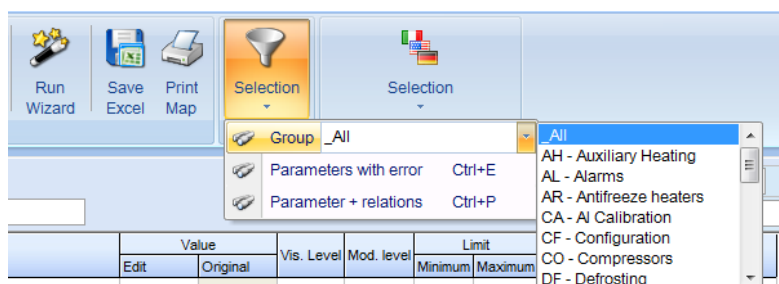

8.4.3 Change Parameters Value

If some parameters' value need to be changed, input the new values in "Value" cell.

Group	Parameter	Description	Value		Vis. Level	Mod. level	Limit		Unit	Comment
			Edit	Original			Minimum	Maximum		
ST - Temperature	ST1	Chiller set point	30.0	30.0	1 - Pr1	1 - Pr1	0.0	30.0	°C	
ST - Temperature	ST2	Minimum chiller set point	0.0	0.0	3 - Pr3	3 - Pr3	-50.0	30.0	°C	
ST - Temperature	ST3	Maximum chiller set point	30.0	30.0	3 - Pr3	3 - Pr3	0.0	110.0	°C	



Then press button  to download new parameters' value into the controller.

Or user can right click on the table, in the pop-out menu, click on "Send Changed parameters".

Group	Parameter	Description	Edit
ST - Temperature	ST1	Chiller set point	
ST - Temperature	ST2	Minimum chiller set point	
ST - Temperature	ST3	Maximum chiller set point	
ST - Temperature	ST4	Heat pump set point	
ST - Temperature	ST5	Heat pump minimum set point	
ST - Temperature	ST6	Heat pump maximum set point	
ST - Temperature	ST7	Intervention temperature	
ST - Temperature	ST8	Intervention temperature	
ST - Temperature	ST9	Chiller temperature	
ST - Temperature	ST10	Heat pump temperature	
ST - Temperature	ST11	Defines the type of intervention	
ST - Temperature	ST12	Defines the type of intervention	

- Standard column order
- Group
- Parameter + relations Ctrl+P
- Parameters with error Ctrl+E
- Reset Filter F12
- Select all parameters
- MultiLanguages Description
- Custom Description
- Send Selected parameters F10
- Send Changed parameters F11**
- Show Math

8.4.4 Save/Open Map



Press button  to save the map. All of the currently parameters value will be wrote into a .bin file which can be open and used in the future.

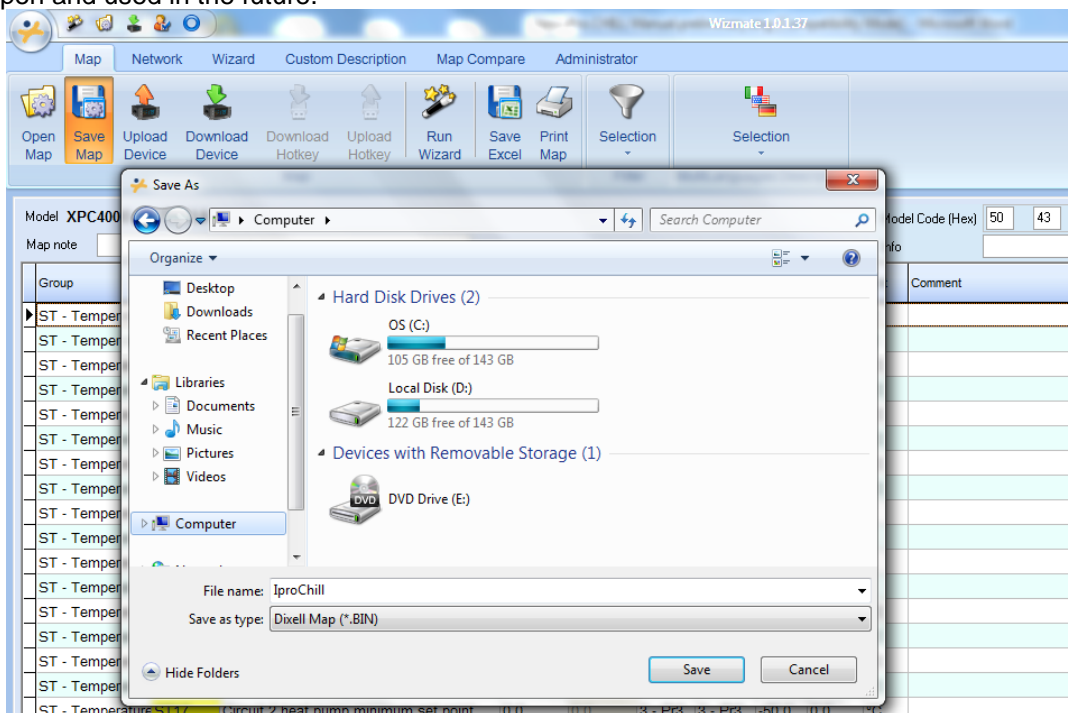



To open the map file, press button **Open Map**, then select the .bin file.

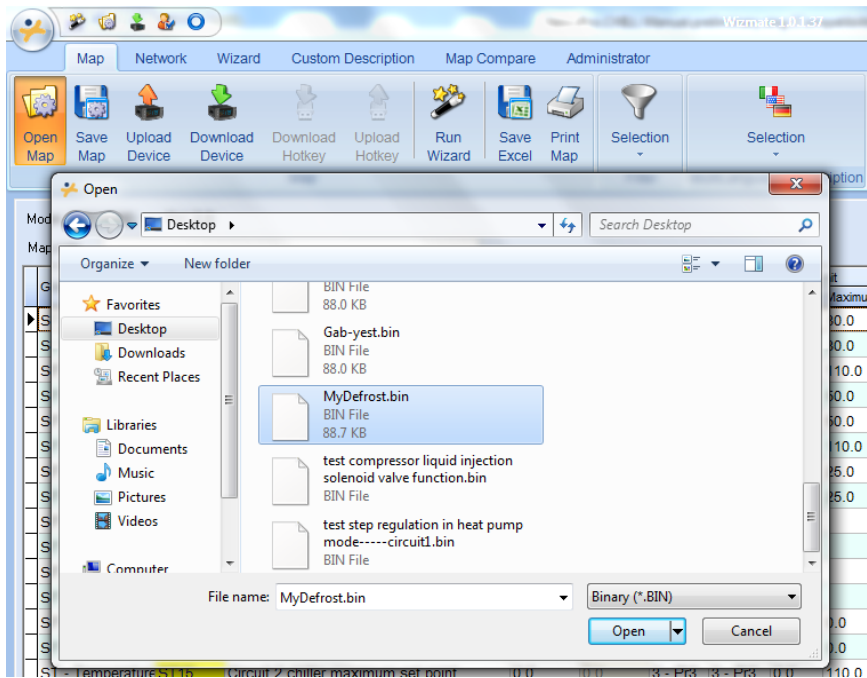

9. PARAMETERS IN TABLE FORM

Parameter groups:

Label	Meaning
ST	Display temperature control parameters
DP	Display variables to be shown on the keyboard
CF	Display configuration parameters
SP	Display parameters for machine set up
Sd	Display dynamic set-point parameters
ES	Display energy saving and automatic timed switch-on/off parameters
AH	Display auxiliary heating parameters
CO	Display compressor parameters
SL	Display stepless compressor parameters
PA	Display evaporator/condenser water pump parameters
Pd	Display pump down function parameters
Un	Display unloading function parameters
FA	Display ventilation parameters
Ar	Display anti-freeze heaters parameters
dF	Display defrost parameters
rC	Display heat recovery parameters
FS	Display production of domestic hot water parameters
FC	Display free-cooling function parameters
US	Display auxiliary output parameters
AL	Display alarm parameters
Et	Display parameters for the management of the electronic expansion valve
IO	Display inputs/outputs configuration parameters
CA	Display analog input calibration parameters
RA	Display analog input range parameters

Temperature control					
Parameter	Description	min	max	um	Resolution
ST 1	Chiller set point This allows you to set the working set point in chiller mode	ST02	ST03	°C/°F	Dec/int
ST 2	Minimum chiller set This defines the minimum limit that can be used for the working set point in chiller mode	-50.0 -58	ST03	°C °F	Dec int
ST 3	Maximum chiller set point This defines the maximum limit that can be used for the working set point in chiller mode	ST02	110 230	°C °F	Dec int
ST 4	Heat pump set point This allows you to set the working set point in h.p. mode	ST05	ST06	°C/°F	dec/int
ST 5	Heat pump minimum set point This defines the minimum limit that can be used for the working set point in heat pump mode	-50.0 -58	ST06	°C °F	Dec int
ST 6	Heat pump maximum set point This defines the maximum limit that can be used for the working set point in heat pump mode	ST05	110 230	°C °F	Dec int
ST 7	Intervention band regulation steps in chiller mode	0.1 1	25.0 45	°C °F	Dec int
ST 8	Intervention band regulation steps in heat pump mode	0.1 1	25.0 45	°C °F	Dec int
ST 9	Chiller temperature control probe 0 - evaporator input NTC 1 - Evaporator output 1 NTC 2 - Evaporator output 2 NTC 3 - Evaporator common output NTC	0	4		

ST 10	Heat pump temperature control probe 0 - evaporator input NTC 1 - Evaporator output 1 NTC 2 - Evaporator output 2 NTC 3 - Evaporator common output NTC 5 - condenser water common input NTC 6 - circuit 1 condenser water input NTC 7 - circuit 2 condenser water input NTC 8 - circuit 1 condenser water output NTC 9 - circuit 2 condenser water output NTC 10 - condenser water common output NTC WARNING If the same temperature control is required in cooling and heating mode, set the same value in the ST09 and ST10 parameters	0	10		
ST 11	Defines the type of temperature control 0 = Proportional 2 = Neutral zone	0	4		
ST 12	Defines the temperature control logic 0 = Of machine 1 = on two separate circuits	0	1		
Circuit 2 regulation if temperature control is enabled on two separate circuits					
ST 13	Circuit 2 chiller set point This allows you to set the working set point in chiller mode	ST14	ST15	°C/°F	dec/int
ST 14	Circuit 2 chiller minimum set point This defines the minimum limit that can be used to set the working set point in chiller mode	-50.0 -58	ST15	°C °F	Dec int
ST 15	Circuit 2 chiller maximum set This defines the maximum limit that can be used to set the working set point in chiller mode	ST14	110 230	°C °F	Dec int
ST 16	Circuit 2 heat pump set point This allows you to set the working set point in h.p. mode	ST17	ST18	°C/°F	dec/int
ST 17	Circuit 2 heat pump minimum set point This defines the minimum limit that can be used to set the working set point in heat pump mode	-50.0 -58	ST18	°C °F	Dec int
ST 18	Circuit 2 heat pump maximum set point This defines the maximum limit that can be used to set the working set point in heat pump mode	ST17	110 230	°C °F	Dec int
ST 19	Intervention band regulation steps of circuit 2 in chiller mode	0.1 1	25.0 45	°C °F	Dec int
ST 20	Intervention band regulation steps in circuit 2 heat pump	0.1 1	25.0 45	°C °F	Dec int
ST 21	Circuit 2 chiller temperature control probe 0 - evaporator input NTC 1 - Evaporator output 1 NTC 2 - Evaporator output 2 NTC 3 - Evaporator common output NTC	0	4		
ST 22	Circuit 2 heat pump temperature control probe 0 - evaporator input NTC 1 - Evaporator output 1 NTC 2 - Evaporator output 2 NTC 3 - Evaporator common output NTC 5 - condenser water common input NTC 6 - circuit 1 condenser water input NTC 7 - circuit 2 condenser water input NTC 8 - circuit 1 condenser water output NTC 9 - circuit 2 condenser water output NTC 10 - condenser water common output NTC	0	10		
Circuit 1 PID regulation					
Parameter	Description	min	max	um	Resolution
ST 23	Circuit 1 band offset	-25.0 -45	25.0 45	°C °F	Dec int
ST 24	Circuit 1 integral sampling time	0	250	Sec	
ST 25	Circuit 1 derived sampling time	0	250	Sec	
Circuit 2 PID regulation					
ST 26	Circuit 2 band offset	-25.0 -45	25.0 45	°C °F	Dec int
ST 27	Circuit 2 integral sampling time	0	250	Sec	
ST 28	Circuit 2 derived sampling time	0	250	Sec	
ST 29	Activation offset with regulation of the neutral zone When the controlled temperature (coming from neutral zone) enters the compressors activation zone the compressors/capacity steps are enabled only if the variable exceeds (in cooling) or drops below (in heating) the relevant threshold for at least ST30.	0.0 0	25.0 45	°C °F	Dec Int

ST 30	Activation delay with regulation of the neutral zone The controlled variable must be over (in cooling) or under (in heating) the above mentioned activation level for at least the ST30 time before the compressor/capacity step is switched ON.	0	250	Sec	
ST 31	Deactivation offset with regulation of the neutral zone When the controlled temperature (coming from neutral zone) enters the compressors disabling zone the compressors/capacity steps are disabled only if the variable drops below (in cooling) or exceeds(in heating) the relevant threshold of at least ST32.	0.0 0	25.0 45	°C °F	Dec Int
ST 32	Deactivation delay with regulation of the neutral zone The controlled variable must be under (in cooling) or over (in heating) the above mentioned activation level for at least the ST32 time before the compressor/capacity step is switched OFF.	0	250	Sec	
Displays					
Parameter	Description	min	max	um	Resolution
Remote terminal 1					
DP1	Row 1 of Visograph keyboard 1 analogue input display 0 = no display (the line remains empty), others are same with probe configuration	0	36		
DP2	Row 2 of Visograph keyboard 1 analogue input display 0 = no display (the line remains empty) , others are same with probe configuration	0	36		
DP3	Row 3 of Visograph keyboard 1 analogue input display 0 = no display (the line remains empty) , others are same with probe configuration	0	36		
DP4	Row 4 of Visograph keyboard 1 analogue input display 0 = no display (the line remains empty) , others are same with probe configuration	0	36		
Remote terminal 2 (Not Available)					
DP5	Not used				
DP6	Not used				
DP7	Not used				
DP8	Not used				
Led Display					
DP9	Top led display screen with unit on 0 = No View 1 = Evaporator input temperature 2 = Evaporator 1 Output temperature 3 = Evaporator 2 Output temperature 4 = Common Evaporator output temperature 5 = Common Condenser input temperature 6 = Condenser 1 water input temperature 7 = Condenser 2 water input temperature 8 = Condenser output temperature 1 9 = Condenser output temperature 2 10 = Common Condenser output temperature 11 = External air temperature 12 = Remote terminal temperature 13 = Combined defrost temperature circuit 1 14 = Combined defrost temperature circuit 2 15 = Condensation temperature circuit 1 16 = Condensation temperature circuit 2 17 = Set point 18 = Hysteresis 19 = Unit status	0	19		

DP10	Bottom led display screen with unit on 0 = No View 1 = Evaporator input temperature 2 = Evaporator 1 Output temperature 3 = Evaporator 2 Output temperature 4 = Common Evaporator output temperature 5 = Common Condenser input temperature 6 = Condenser 1 water input temperature 7 = Condenser 2 water input temperature 8 = Condenser 1 water output temperature 9 = Condenser 2 water output temperature 10 = Condenser common output temperature 11 = External air temperature 12 = Remote terminal temperature 13 = Combined defrost temperature circuit 1 14 = Combined defrost temperature circuit 2 15 = Condensation temperature circuit 1 16 = Condensation temperature circuit 2 17 = Set point 18 = Hysteresis 19 = Unit status 20 = Condensation pressure circuit 1 21 = Condensation pressure circuit 2 22 = Evaporation pressure circuit 1 23 = Evaporation pressure circuit 2 24 = RTC clock	0	24		
DP11	Led display screen with unit in stand-by 0 = Stby above, nothing underneath 1 = Defined by parameters dP9 and dP10 2 = OFF above, nothing underneath	0	2		
DP12	HMI type (Can be seen only in Wizmate by Administrator). 0 = Visograph 1 1 = Visograph 2 2 = Visotouch For visograph 2 and Visotouch: Leds green: always on; Leds red: on when alarm active or resettable	0	2		
Configuration					
Parameter	Description	min	max	um	Resolution
Unit					
CF 1	Defines the type of unit to control 0 = Air to air unit 1 = Air to water 2 = Water to water	0	2		
CF 2	Selection of unit working mode 1 = chiller only 2 = heat pump only 3 = chiller with heat pump	1	3		
CF 3	Enable compressor operation 0 = chiller and heat pump 1 = chiller only 2 = heat pump only	0	2		
CF 4	Motor-condensing unit 0 = no 1 = yes Temperature control, dynamic set point and energy saving functions are automatically disabled when CF04 = 1	0	1		
Circuits/compressors					
CF 5	Number of compressors in circuit 1	1	3 (1 if CF9# 0)		
CF 6	Number of compressors in circuit 2	0	3 (1 if CF10# 0)		
CF 7	Not used				
CF 8	Not used				
CF 9	Circuit 1 compressor unloaders 0 = 1 step per compressor 1 = 2 steps per compressor 2 = 3 steps per compressor 3 = 4 steps per compressor	0	3		

CF 10	Circuit 2 compressor unloaders 0 = 1 step per compressor 1 = 2 steps per compressor 2 = 3 steps per compressor 3 = 4 steps per compressor	0	3		
CF 11	Not used				
CF 12	Not used				
Machine Set Up					
Parameter	Description	min	max	udm	Resolution
Analogue Inputs					
SP 1	Working in temperature or pressure from an analog input 0 - NTC cond. temperature / evap. pressure 4.0.20mA: The condensation temperature is controlled through the use of an NTC probe, while a transducer with an input of 4-20 mA must be used to control the evaporation pressure of the circuits and the pressure of the pressure probe configured as an auxiliary output 1 - Condensation and evaporation pressure 4.0.20mA: A transducer with an input of 4-20 mA must be used to control the condensation or evaporation pressures 2 - NTC cond. temperature / evap. pressure 0..5V: The condensation temperature is controlled through the use of an NTC probe, while a ratiometric transducer with an input of 0-5V must be used to control the evaporation pressure of the circuits and the pressure of the pressure probe configured as an auxiliary output 3 - Condensation and evaporation pressure 0..5V: A ratiometric transducer with an input of 0-5 V must be used to control the condensation or evaporation pressures Note: SP01 will affect some parameters' measurement unit.	0	3		
Type of gas					
Parameter	Description	min	max	udm	Resolution
SP 2	Type of gas used to calculate the saturated temperatures 1=R22 2=R407c 3=R134a 4=R410a 5=R404a 6=R290	1	6		
SP 3	Choice between absolute and relative pressure to calculate overheating: 0 = Relative 1 = Absolute	0	1		
Parameter	Description	min	max	udm	Resolution
SP 4	Not used				
SP 5	Not used				
SP 6	Not used				
SP 7	Not used				
Working mode					
SP 8	Operating logic 0= ❄️ chiller / ☀️ h.p. 1= ☀️ chiller / ❄️ h.p.	0	1		
Chiller / heat pump mode selection					
SP 9	Chiller / heat pump mode selection 0 = from the keyboard 1 = from a digital input 2 = from an analog input	0	2		
Automatic change over					
Parameter	Description	min	max	udm	Resolution
SP 10	Automatic chiller / heat pump mode changeover setting	-50.0 -58	110 230	°C °F	Dec int
SP 11	Automatic chiller / heat pump mode changeover differential	0.1 1	25.0 45	°C °F	Dec int
Unit of measurement selection					
SP 12	Measurement Unit selection 0 = °C / BAR 1 = °F / psi	0	1		
Network frequency selection					
SP 13					
Serial address					
SP 14	Serial address	1	247		
SP 15	Firmware release				

SP 16	Eeprom map of parameters				
Password					
SP 17	Level 2 password	0	9999		
SP 18	Level 3 password	0	9999		
Dynamic set-point					
Parameter	Description	min	max	um	Resolution
Sd 1	Maximum increase in chiller mode dynamic set point This determines the maximum variation of the working set point in chiller mode	-50.0 -58	110 230	°C °F	Dec int
Sd 2	Maximum increase in heat pump mode dynamic set point This determines the maximum variation in the working set point in heat pump mode	-50.0 -58	110 230	°C °F	Dec int
Sd 3	Dynamic set point in chiller mode for the external air temperature setting	-50.0 -58	110 230	°C °F	Dec int
Sd 4	Dynamic set point in heat pump mode for the external air temperature setting	-50.0 -58	110 230	°C °F	Dec int
Sd 5	External air temperature differential dynamic set point in chiller mode	-25.0 -45	25.0 45	°C °F	Dec int
Sd 6	Dynamic set point in heat pump mode for the external air temperature differential	-25.0 -45	25.0 45	°C °F	Dec int
Energy saving					
Parameter	Description	min	max	um	Resolution
ES 1	Start of working time band 1 (0-24)	0	24.00	Hr	10 Min
ES 2	End of working time band 1 (0-24)	0	24.00	Hr	10 Min
ES 3	Start of working time band 2 (0-24)	0	24.00	Hr	10 Min
ES 4	End of working time band 2 (0-24)	0	24.00	Hr	10 Min
ES 5	Start of working time band 3 (0-24)	0	24.00	Hr	10 Min
ES 6	End of working time band 3 (0-24)	0	24.00	Hr	10 Min
ES 7	Monday energy saving time band 0 = None 1 = Time Band 1 2 = Time Band 2 3 = Time Bands 1 and 2 4 = Time Band 3 5 = Time Bands 1 and 3 6 = Time Bands 2 and 3 7 = All time bands	0	7		
ES 8	Tuesday energy saving time band	0	7		
ES 9	Wednesday energy saving time band	0	7		
ES 10	Thursday energy saving time band	0	7		
ES 11	Friday energy saving time band	0	7		
ES 12	Saturday energy saving time band	0	7		
ES 13	Sunday energy saving time band	0	7		
ES 14	Increase energy saving setting in chiller mode	-50.0 -58	110 230	°C °F	Dec int
ES 15	Energy saving differential in chiller mode	0.1 1	25.0 45	°C °F	Dec int
ES 16	Energy saving setting increase in heat pump mode	-50.0 -58	110 230	°C °F	Dec int
ES 17	Energy saving differential increase in heat pump mode	0.1 1	25.0 45	°C °F	Dec int
ES 18	Monday automatic shutdown time band	0	7		
ES 19	Tuesday automatic shutdown time band	0	7		
ES 20	Wednesday automatic shutdown time band	0	7		
ES 21	Thursday automatic shutdown time band	0	7		
ES 22	Friday automatic shutdown time band	0	7		
ES 23	Saturday automatic shutdown time band	0	7		
ES 24	Sunday automatic shutdown time band	0	7		
ES 25	Maximum unit working time in OFF from RTC if forced ON via a key	0	250	Min	10 Min
Auxiliary heating					
Parameter	Description	min	max	um	Resolution
AH 1	Auxiliary heating function 0 = Disabled 1 = enabled with control in integration mode 2 = enabled with control in heating mode	0	2		
AH 2	External air set point auxiliary heating activation	-50.0 -58	110 230	°C °F	Dec int
AH 3	External air differential auxiliary heating deactivation	0.1 1	25.0 45	°C °F	Dec int
AH 4	Auxiliary heating activation delay time	0	250		
AH 5	External air set point that deactivates the compressors working in integration mode	-50.0	110	°C °F	Dec int

AH 6	External air differential that activates the compressors in integration mode	0.1 1	25.0 45	°C °F	Dec int
AH 7	Off compressors delay time in integration mode	0	250		
AH 8	Thermoregulation selection set 0 = uses the set point (ST04) and the differential (ST08) of the HP 1 = uses the set point and the differential of the auxiliary heating function 2 = add the parameters AH9/AH11 to HP set point (ST04) and use the differentials AH10/AH12	0	2		
AH 9	Auxiliary heating set point on / off	-50.0 -58	110 230	°C °F	Dec int
AH 10	Band proportional auxiliary heating ON / OFF	0.1 1	25.0 45	°C °F	Dec int
AH 11	Auxiliary modulating heating set point	-50.0 -58	110 230	°C °F	Dec int
AH 12	Auxiliary modulating heating proportional band	0.1 1	25.0 45	°C °F	Dec int
AH 13	Auxiliary heating modulating minimum output value	0	AH14	%	
AH 14	Auxiliary heating modulating maximum output value	AH13	100	%	
AH 15	Auxiliary Output heating minimum maintaining value of to higher temperatures modulating the set point 0 = Not enabled 1 = Enabled	0	1		
AH 16	Enable the auxiliary heater in defrost 0 = Not enabled 1 = Enabled	0	1		
Compressor					
Parameter	Description	min	max	um	Resolution
CO 1	Compressor minimum ON time Determines the length of time the compressor must remain active after being switched on, even if the request ceases.	0	250	Sec	10 sec
CO 2	Minimum compressor OFF time Determines the length of time the compressor must remain deactivated even if a request is transmitted for it to switch on again. During this stage, the LED pertaining to the compressor will flash.	0	250	Sec	10 sec
CO 3	Minimum time between one activation and another on the same compressor	0	250	Sec	10 sec
CO 4	Activation delay between 2 compressors/steps With two compressors this establishes the start-up delay between the two, to reduce absorption at peaks. During this stage, the LED pertaining to the compressor will flash. (only for the compressor) With units with partialised compressor. This determines switch-on time of the unloader solenoid for start-up at minimum capacity (see compressors start-up)	1	250	Sec	
CO 5	Shut off delay between 2 compressors / steps This establishes the shut off delay between the two compressors two unloader steps	1	250	Sec	
CO 6	Not used				
CO 7	Compressor switch-on delay from power ON (power from the mains). Delays activation of all the outputs in order to distribute the mains consumption and protect the compressors from repeated activation in case of frequent power failures	0	250	Sec	10 sec
Unloaders					
CO 8	Unloaders operation (see unloaders operation) 0 = ON/OFF step insertion 1 = continuous insertion with direct action steps 2 = continuous insertion with inverse action steps 3 = Insertion with continuous direct global steps	0	3		
CO 9	Enabling upon operation of the minimum power of the compressor / idle start-up management 0 = Enables minimum power only upon compressor start-up (start-up upon minimum capacity/idle valve start-up in OFF with compressor off) 1 = Screw valves enable the minimum power at compressor start-up and in temperature control (start-up with minimum capacity / idle start-up valve in OFF with compressor off) 2 = Screw valves enable the minimum power at compressor start-up (start-up with minimum capacity / idle start-up valve in ON with compressor off) 3 = Screw valves enable the minimum power at compressor start-up and in temperature control (start-up with minimum capacity / idle start-up valve in ON with compressor off)	0	3		
Intermittent valve function					
CO 10	Screw compressor intermittent valve control relay ON time 0 = function is disabled	0	250	Sec	
CO 11	Screw compressor intermittent valve control relay OFF time	0	250	Sec	
Compressor start-up					

CO 12	Compressor start-up (see compressor start-up) 0 = direct 1 = part - winding 2 = star delta	0	2		
CO 13	If CO12 = 1 part - winding start-up time applies. This allows you to vary the attachment of the two relays that supply the two motor coils. If CO12 = 2 star triangle start-up time applies. This allows you to vary the simultaneous operation time of the line 1 relay and the relay that closes the star centre connection. (see start-up par.)	0	250	Tenths of sec	0.1 sec
CO 14	If CO12 = 2 star triangle start-up time applies. This allows you to vary the time from unhooking the star centre relay from the hook on the relay of line 2 (see start-up par.)	0	250	Hund. of sec	0.01 sec
CO 15	Switch-on time with gas bypass valve / idle compressor start-up valve (see unloader mode)	0	250	Sec	
Compressors rotation – balancing – temperature control					
CO 16	Selection criteria of compressors in the circuit 0 = Fixed sequence 1 = FIFO 2 = Balance 3 = Saturation	0	4		
CO 17	Selection criteria of circuits 0 = Fixed sequence 1 = FIFO 2 = Balance 3 = Saturation	0	4		
CO 18	Balance/saturation criteria 0= Hours 1= Starts	0	1		
CO 19	Not used				
CO 20	Not used				
CO 21	Not used				
CO 22	Not used				
CO 23	Not used				
CO 24	Not used				
CO 25	Not used				
CO 26	Not used				
CO 27	Not used				
CO 28	Not used				
CO 29	Not used				
CO 30	Not used				
CO 31	Not used				
CO 32	Not used				
CO 33	Not used				
CO 34	Not used				
CO 35	Maximum n° of compressor starts after 15 minutes ON 0 = function disabled	0	15		
Resource control in proportional/neutral zone mode					
CO 36	Max time with no resources being inserted with at least one resource active	0	250	Min	10 Min
CO 37	Max time in a neutral zone with no resources rotating	0	999	Hr	1Hr
Compressor in tandem forced rotation function					
CO 38	Maximum continuous working time for individual compressor in the circuit.	0	250	Min	
Compressor with modulating control					
CO 39	Compressor operation time at maximum speed requested by temperature control 0 = function is disabled	0	250	Sec	
CO 40	Minimum value for digital scroll 0-10V analogue output at peak	0	100	%	
CO 41	Power implementation interval at peak	0	250	Sec	
CO 42	Determines the minimum continuative operation percentage of the modulating compressor below which the CO43 time count starts 0 = function is disabled	0	100	%	
CO 43	MAX continuative operation time of modulating compressor with operation percentage below CO42 0 = function is disabled	0	250	Min	10 Min
CO 44	Forced working time at maximum speed	0	250	Sec	10sec
CO 45	Maximum continuative operation time of modulating compressor after which the modulating compressor is switched off and insertion of another compressor is forced depending on rotation 0 = function is disabled	0	999	Hr	1Hr
CO 46	Minimum value for circuit 1 inverter 0-10V analogue output	0	CO47	%	
CO 47	Maximum value for circuit 1 inverter 0-10V analogue output	CO46	100	%	
CO 48	Minimum value for circuit 2 inverter 0-10V analogue output	0	CO49	%	
CO 49	Maximum value for circuit 2 inverter 0-10V analogue output	CO48	100	%	
CO 50	Normal power implementation interval	1	250	Sec	
Compressors liquid injection function					

CO 51	Activation set point of the liquid injection solenoid valve	-50.0 -58	150.0 302	°C °F	Dec int
CO 52	Differential deactivation of the liquid injection solenoid valve	0.1 0	25.0 45	°C °F	Dec int
Loads maintenance					
CO 53	Compressor 1 timer setting	0	999	Hr	10 Hr
CO 54	Compressor 2 timer setting	0	999	Hr	10 Hr
CO 55	Compressor 3 timer setting	0	999	Hr	10 Hr
CO 56	Compressor 4 timer setting	0	999	Hr	10 Hr
CO 57	Compressor 5 timer setting	0	999	Hr	10 Hr
CO 58	Compressor 6 timer setting	0	999	Hr	10 Hr
CO 59	Not used				
CO 60	Not used				
CO 61	Not used				
CO 62	Not used				
CO 63	Not used				
CO 64	Not used				
CO 65	Not used				
CO 66	Not used				
CO 67	Not used				
CO 68	Not used				
CO 69	Delay time in enabling Refcomp Inverter compressor relay based on temperature control request	0	250	sec	
CO 70	Delay in VI valves activation from compressor start-up	0	250	sec	
CO 71	Minimum activation time for VI valves	0	250	sec	
Stepless compressor					
Parameter	Description	min	max	um	Resolution
SL 1	Compressors stepless adjustment 0 = not active function 1 = Bitzer compressor active function 2 = Fu Sheng compressor active function	0	2		
SL 2	Pulses number to consider the stepless compressors of circuit 1 to 100%	1	250		
SL 3	Pulses number to consider the stepless compressors of circuit 2 to 100%	1	250		
SL 4	Not used				
SL 5	Not used				
SL 6	Delay pulse valves	1	250		0.1 sec
SL 7	Minimum interval between two consecutive pulses	1	SL8	Sec	
SL 8	Maximum interval between two consecutive pulses	SL7	250	Sec	
SL 9	Dead band in chiller operation	0.1 1	25.0 45	°C °F	Dec int
SL 10	Dead band in heat pump operation	0.1 1	25.0 45	°C °F	Dec int
Water pump					
Evaporator water pump control					
PA 1	Evaporator pump/supply fan operation mode 0 = Absent (pump and supply fan are not controlled). 1 = Continuous operation: the pump/supply fan is activated when the machine is switched on (chiller/h.p. selection). 2 = Working on demand of the compressors: the water pump/supply fan are linked with the compressors being switched on and off.	0	2		
PA 2	Compressor ON delay from pump/ supply fan start	0	250	Sec	10 Sec
PA 3	Evaporator water pump/supply fan OFF delay from when the compressors are shut off	0	250	Sec	10 Sec
PA 4	Deactivation Pump Delay from when the unit is Switched Off	0	250	Sec	10 Sec
PA 5	Pump Activation and Rotation: 0 = No Rotation; 1 = Manual Rotation; 2 = Start Rotation; 3 = Rotation at Hours; 4 = Rotation at Start and Hours	0	4		
PA 6	Manual Pump Inversion: 0= Pump 1 On; 1= Pump 2 On;	0	1		
PA 7	No. of hours for forced evaporator pump rotation	0	999	Hr	10Hr
PA 8	Simultaneous pump running time after forced pump rotation	0	250	Sec	
Evaporator water pump operation with anti-freeze alarm					
PA9	Determines the evaporator water pump/s anti-freeze operation when the device is OFF or on Stand-by 0 = always OFF in remote OFF or Stand-by 1 = ON, parallel with the anti-freeze heaters 2 = on in remote OFF or Stand-by, depending on the temperature control request	0	2		

PA10	Temperature control probe for anti-freeze evaporator water pump/s operation 0 = disabled 1 = evaporator input 2 = evaporator output 1 3 = evaporator output 2 4 = evaporator output 1/2 5 = evaporator output 1/2 and common output 6 = external air temperature	0	6		
PA11	Evaporator water pump activation set point in anti-freeze mode on the temperature control probe	-50.0 -58	110 230	°C °F	Dec int
PA12	Evaporator water pump differential deactivation in anti-freeze mode on the temperature control probe	0.1 0	25.0 45	°C °F	Dec int
Evaporator water pump maintenance request					
PA 13	Main pump/supply fan timer setting	0	999	Hr	10 Hr
PA 14	Evaporator no. 2 pump timer setting	0	999	10 Hr	10 Hr
Hot start function of the supply fan air/air unit					
PA 15	Hot start set-point	-50.0 -58	110 230	°C °F	Dec int
PA 16	Hot start differential	0.1 1	25.0 45	°C °F	Dec int
Condenser water pump management					
PA 17	Condenser pump operation mode 0 = Absent (pump not controlled). 1 = Continuous operation: the pump being switched on and off is linked with the unit being switched on and off. 2 = Working on demand of the compressors: pump switch-on and off is linked with the compressors being switched on and off.	0	2		
PA 18	Compressor ON delay from condenser pump start-up	0	250	Sec	10 Sec
PA 19	Condenser pump OFF delay from compressor shut off	0	250	Sec	10 Sec
PA 20	Deactivation pump delay from when the unit is switched off	0	250	Sec	10 Sec
PA 21	Pump activation and rotation: 0 = No Rotation; 1 = Manual Rotation; 2 = Start Rotation; 3 = Rotation at Hours; 4 = Rotation at Start and Hours	0	4		
PA 22	Manual pump inversion: 0 = Pump 1 On; 1 = Pump 2 On	0	1		
PA 23	No. of hours for forced condenser pump rotation	0	999	Hr	10Hr
PA 24	Simultaneous pump running time after forced condenser pump rotation	0	250	Sec	
Condenser water pump operation with anti-freeze alarm					
PA 25	Condenser water pump/s anti-freeze operation when the device is OFF or on Stand-by 0 = always OFF in remote OFF or Stand-by 1 = ON, parallel with the anti-freeze heaters 2 = on in remote OFF or Stand-by, depending on the temperature control request	0	2		
PA 26	Condenser anti-freeze temperature control probe alarm 0 = disabled 1 = common condenser water input probe 2 = common condenser water input probe and condenser input 1 3 = common condenser water input probe and condenser input 2 4 = condenser water output probe 1 5 = condenser water output probe 2 6 = condenser output 1/2 7 = condenser output 1/2 and common output 8 = external air temperature	0	8		
PA 27	Condenser water pump activation set point in anti-freeze mode on the temperature control probe	-50.0 -58	110 230	°C °F	Dec int
PA 28	Condenser water pump differential deactivation in anti-freeze mode on the temperature control probe	0.1 1	25.0 45	°C °F	Dec int
Condenser water pump maintenance request					
PA 29	Condenser pump timer setting	0	999	Hr	10 Hr
PA 30	Condenser no. 2 pump timer setting	0	999	Hr	10 Hr
Pump down function					
Pump down					
Pd 1	Pump down operation 0= function disabled 1= disabled with pump down 2= disabled and enabled with pump down 3= disabled with pump down only in chiller mode 4= enabled with pump down and disabled with pump down only in chiller mode	0	4		

Pd 2	Pump down pressure setting (see pump down chapter)	0.0 0	50.0 725	Bar psi	Dec int
Pd 3	Pump down pressure differential (see pump down chapter)	0.1 1	14.0 203	Bar Psi	Dec int
Pd 4	Maximum time in Pump down when started-up and stopped (see pump down chapter)	0	250	Sec	
Timed pump down					
Pd 5	Pump down time upon start-up 0 = function disabled	0	250	Sec	
Pd 6	Pump down time upon shutdown 0 = function disabled	0	250	Sec	
Pump down alarm					
Pd 7	Maximum number of pump down alarm interventions per hour, at stopped. When exceeded, the alarm is recorded and displayed on the screen with a code and the relay alarm + buzzer is activated Reset is always manual if Pd7 = 0 Reset is always automatic if Pd7 =60 Reset switches from automatic to manual if Pd7 falls between 1 and 59	0	60		
Pd 8	Maximum number of pump down alarm interventions per hour, at started-up. Exceeding this limit, the alarm must be reset manually, it will be saved in the log and the alarm relay + buzzer will be activated Reset is always manual if Pd8 = 0 Reset is always automatic if Pd8 =60 Reset switches from automatic to manual if Pd8 falls between 1 and 59 and based on the configuration of Par. Pd9	0	60		
Pd 9	Pump down alarm automatic or manual reset activation upon start-up 0= the alarm remains in automatic reset even if the number of interventions per hour is met 1=enables manual reset when the number of interventions per hour is met	0	1		
Unloading Function					
Evaporator water high temperate unloading					
Un 1	Comp. unloading set point of the evaporator input high water temperature in chiller mode	-50.0 -58	110.0 230	°C °F	Dec int
Un 2	Compressor unloading differential from the evaporator input high water temperature	0.1 0	25.0 45	°C °F	Dec int
Un 3	Delay for the compressor unloading function to be inserted by an evaporator input high water temperature	0	250	Sec	10 sec
Un 4	MAX time in compressor unloading function by an evaporator input high water temperature	0	250	Min	
Un 5	Analogue input configuration for control of the unloading function of the evaporator high water temperature	1	29		
Evaporator water low temperate unloading					
Un 6	Compressor unloading set point from the evaporator low water temperature	-50.0 -58	110.0 230	°C °F	Dec int
Un 7	Compressor unloading differential from the evaporator low water temperature	0.1 0	25.0 45	°C °F	Dec int
Un 8	Delay for the compressor unloading function to be inserted by an evaporator input low water temperature	0	250	Sec	10 sec
Un 9	MAX time in compressor unloading status due to the evaporator low water temperature	0	250	Min	
Un 10	Analogue input configuration for control of the unloading function of the evaporator low water temperature	1	29		
Chiller condensation unloading					
Un 11	Condensing temperature/pressure compressor unloading set point	-50.0 -58 0.0 0	110.0 230 50.0 725	°C °F Bar Psi	Dec int Dec int
Un 12	Condensing temperature/pressure compressor unloading differential	0.1 0 0.1 1	25.0 45 14.0 203	°C °F Bar Psi	Dec int Dec int
Evaporation unloading					
Un 13	Evaporation pressure compressor unloading set point	-1.0 -14	50.0 725	Bar Psi	Dec int
Un 14	Evaporation pressure compressor unloading differential	0.1 1	14.0 203	Bar Psi	Dec int
Un 15	MAX time in temperature / pressure compressor unloading status	0	250	Min	
Un 16	Choice of steps for circuit to insert in unloading mode	1	8		
Un 17	Not used				
Condensing fan					
Parameter	Description	min	max	um	Resolution

FA1	Fan regulation 0= absent 1= always ON 2 =ON/OFF step insertion 3= continuous ON/OFF step insertion 4= speed proportional regulator	0	4		
FA2	Fan working mode 0= depending on the compressor 1= independent from the compressor	0	1		
FA3	MAX speed fan peak time after ON (TRIAC) At every start-up the fan is powered at maximum voltage for time FA03, irrespective of the condensation temperature/pressure. When this elapses, the fan continues at the speed set by the regulator.	0	250	Sec	
FA4	Fan phase displacement analog output 5 (only if configured as PWM / phase cut)	0	8	micro sec	250µs
FA5	Fan phase displacement analog output 6 (only if configured as PWM / phase cut)	0	8	micro sec	250µs
FA6	Single or separate condensation fan 0= unique condensation (1 / 2) 1= separate condensers	0	1		
FA7	Pre ventilation before switching compressor ON. It allows you to set a start up time for the fans at the maximum speed in chiller mode before the compressor is switched on, in order to prepare for the sudden increase in condensation temperature / pressure (that starting up the compressor entails) and improving regulation. (only if FA01 = 4)	0	250	Sec	
Chiller mode					
FA8	Minimum operation speed of the chiller fans. This allows you to set a minimum value for proportional fan regulation in chiller mode. It is expressed as a percentage of the maximum voltage allowed.	0	FA16	%	
FA9	Maximum operation speed of the chiller fans. This allows you to set a maximum value for proportional fan regulation in chiller mode. It is expressed as a percentage of the maximum voltage allowed.	FA16	100	%	
FA10	Proportional regulation Minimum fan speed Set temperature/pressure in chiller mode. This allows you to set the condensation temperature / pressure value in chiller that corresponds to the minimum fan speed. Step regulation SET 1st STEP This allows you to set the condensation temperature / pressure value in chiller mode that corresponds to operation in ON of the relay output, configured as the 1st condensation fan speed step.	-50.0 -58 0.0 0	110 230 50.0 725	°C °F Bar Psi	Dec int Dec int
FA11	Proportional regulation Set maximum fan speed temperature/pressure in chiller mode. This allows you to set the condensation temperature / pressure value in chiller that corresponds to the maximum fan speed. Step regulation SET 2nd STEP This allows you to set the condensation temperature / pressure value in chiller mode that corresponds to the operation in ON of the relay output, configured as the 2nd condensation fan speed step.	-50.0 -58 0.0 0	110 230 50.0 725	°C °F Bar Psi	Dec int Dec int
FA12	Proportional regulation Proportional band regulation of fans in chiller mode This allows you to set a temperature / pressure differential that corresponds to a variation from minimum to maximum fan speed. Step regulation With Par. FA01=2/3 becomes the differential on the step itself of circuit 1 in chiller (see fans regulation graph).	0.1 0 0.1 1	25.0 45 14.0 203	°C °F Bar Psi	Dec int Dec int
FA13	Proportional regulation Differential CUT- OFF in chiller. This allows you to set a temperature / pressure differential in chiller mode to shut off the fan. Step regulation With Par. FA01=2/3 becomes the differential on the step itself of circuit 2 in chiller (see fans regulation graph).	0.1 0 0.1 1	25.0 45 14.0 203	°C °F Bar Psi	Dec int Dec int
FA14	Over ride CUT- OFF in chiller. This allows you to set a temperature / pressure differential in chiller mode, where the fan maintains minimum speed.	0.1 0 0.1 1	25.0 45 14.0 203	°C °F Bar Psi	Dec int Dec int
FA15	CUT-OFF delay when fans are activated. This allows you to set a delay time for the activation of the CUT - OFF function at fan start-up. If at compressor start-up the proportional regulator requests the fans to be shut off and FA15 <> 0, the fan will be forced at minimum speed for the set time. If FA15=0, the function is not enabled.	0	250	Sec	

FA16	Night function speed in chiller mode. This allows you to set a maximum value for proportional regulation of the fans in chiller mode. It is expressed as a percentage of the maximum voltage allowed.	FA8	FA9	%	
Heat pump mode					
FA17	Minimum fan speed in heat pump mode. This allows you to set a minimum value for the proportional regulation of the fans in h.p. It is expressed as a percentage of the maximum voltage allowed.	0	FA24	%	
FA18	Maximum fan speed in heat pump mode. This allows you to set a maximum value for the proportional regulation of the fans in h.p. It is expressed as a percentage of the maximum voltage allowed.	FA24	100	%	
FA19	Proportional regulation Set temperature / pressure for maximum fan speed in h.p. mode. This allows you to set the condensation temperature / pressure value in h.p. mode that corresponds to minimum fan speed. Step regulation SET 4th STEP This allows you to set the condensation temperature / pressure value in heat pump mode that corresponds to the operation of the relay output in ON configured as the 4th condensation fan speed step.	-50.0 -58 0.0 0	110 230 50.0 725	°C °F Bar Psi	Dec int Dec int
FA20	Proportional regulation Set temperature / pressure for minimum fan speed in h.p. mode. This allows you to set the condensation temperature / pressure value in h.p. mode that corresponds to maximum fan speed. Step regulation SET 3rd STEP This allows you to set the condensation temperature / pressure value in heat pump mode that corresponds to the operation of the relay output in ON configured as the 3rd condensation fan speed step.	-50.0 -58 0.0 0	110 230 50.0 725	°C °F Bar Psi	Dec int Dec int
FA21	Proportional regulation Proportional band regulation of fans in heat pump mode This allows you to set a temperature / pressure differential that corresponds to a variation from minimum to maximum fan speed. Step regulation With Par. FA01=2/3 becomes the differential on the step itself of circuit 1 in heat pump (see fans regulation graph).	0.1 0 0.1 1	25.0 45 14.0 203	°C °F Bar Psi	Dec int Dec int
FA22	Proportional regulation Differential CUT- OFF in heat pump. This allows you to set a temperature / pressure differential in h.p. mode to shut off the fan. Step regulation With Par. FA01=2/3 becomes the differential on the step itself of circuit 2 in heat pump mode (see fans regulation graph).	0.1 0 0.1 1	25.0 45 14.0 203	°C °F Bar Psi	Dec int Dec int
FA23	Over ride CUT- OFF in h.p. This allows you to set a temperature / pressure differential in h.p. mode, where the fan maintains minimum speed.	0.1 0 0.1 1	25.0 45 14.0 203	°C °F Bar Psi	Dec int Dec int
FA24	Night function speed in HP mode. This allows you to set a maximum value for the proportional regulation of the fans in h.p. It is expressed as a percentage of the maximum voltage allowed.	FA17	FA18	%	
Condensation fan step 3 / 4 in chiller mode					
FA25	Third step setting in chiller mode SET 3rd STEP This allows you to set the condensation temperature / pressure value in chiller mode that corresponds to the operation in ON of the relay output, configured as the 3rd condensation fan speed step.	-50.0 -58 0.0 0	110 230 50.0 725	°C °F Bar Psi	Dec int Dec int
FA26	Fourth step setting in chiller mode SET 4th STEP This allows you to set the condensation temperature / pressure value in chiller mode that corresponds to operation in ON of the relay output, configured as the 4th condensation fan speed step.	-50.0 -58 0.0 0	110 230 50.0 725	°C °F Bar Psi	Dec int Dec int
FA27	Not used				
FA28	Not used				
Condensation fan step 3 / 4 in heat pump mode					
FA29	SET 2nd STEP This allows you to set the condensation temperature / pressure value in heat pump mode that corresponds to the operation of the relay output in ON configured as the 2nd condensation fan speed step.	-50.0 -58 0.0 0	110 230 50.0 725	°C °F Bar Psi	Dec int Dec int
FA30	SET 1st STEP This allows you to set the condensation temperature / pressure value in heat pump mode that corresponds to the operation of the relay output in ON configured as the 1st condensation fan speed step.	-50.0 -58 0.0 0	110 230 50.0 725	°C °F Bar Psi	Dec int Dec int
FA31	Not used				
FA32	Not used				
Operation in defrost (df33 = 2)					
FA33	Minimum fan speed in defrost mode. This allows you to set a minimum value for proportional regulation of the fans in defrost mode. It is expressed as a percentage of the maximum voltage allowed.	0	FA40	%	

FA34	Maximum fan speed in defrost mode. This allows you to set a maximum value for proportional regulation of the fans in defrost mode. It is expressed as a percentage of the maximum voltage allowed.	FA40	100	%	
FA35	Proportional regulation Set maximum fan speed temperature/pressure in defrost mode. This allows you to set the condensation temperature / pressure value in defrost mode that corresponds to the minimum fan speed. Step regulation SET 4th STEP This allows you to set the condensation temperature / pressure value in defrost mode that corresponds to operation in ON of the relay output, configured as the 4th condensation fan speed step.	-50.0 -58 0.0 0	110 230 50.0 725	°C °F Bar Psi	Dec int Dec int
FA36	Proportional regulation Set minimum fan speed temperature/pressure in defrost mode. This allows you to set the condensation temperature / pressure value in defrost mode that corresponds to the maximum fan speed. Step regulation SET 3rd STEP This allows you to set the condensation temperature / pressure value in defrost mode that corresponds to operation in ON of the relay output, configured as the 3rd condensation fan speed step.	-50.0 -58 0.0 0	110 230 50.0 725	°C °F Bar Psi	Dec int Dec int
FA37	Proportional regulation Proportional band regulation of fans in defrost. This allows you to set a temperature / pressure differential that corresponds to a variation from minimum to maximum fan speed. Step regulation With Par. FA01=2/3 becomes the differential on the step itself of circuit 1 in defrost mode (see fans regulation graph).	0.1 0 0.1 1	25.0 45 14.0 203	°C °F Bar Psi	Dec int Dec int
FA38	Proportional regulation Differential CUT- OFF in defrost. This allows you to set a temperature / pressure differential in defrost mode to shut off the fan. Step regulation With Par. FA01=2/3 becomes the differential on the step itself of circuit 2 in defrost mode (see fans regulation graph).	0.1 0 0.1 1	25.0 45 14.0 203	°C °F Bar Psi	Dec int Dec int
FA39	Over ride CUT- OFF in defrost. This allows you to set a temperature / pressure differential in defrost where the fan maintains minimum speed.	0.1 0 0.1 1	25.0 45 14.0 203	°C °F Bar Psi	Dec int Dec int
FA40	Night function speed in defrost mode. This allows you to set a maximum value for proportional regulation of the fans in defrost mode. It is expressed as a percentage of the maximum voltage allowed.	FA33	FA34	%	
FA41	Third step setting in defrosting mode SET 2nd STEP This allows you to set the condensation temperature / pressure value in defrost mode that corresponds to relay output operation in ON configured as the 2nd condensation fan speed step.	-50.0 -58 0.0 0	110 230 50.0 725	°C °F Bar Psi	Dec int Dec int
FA42	Fourth step setting in defrosting mode SET 1st STEP This allows you to set the condensation temperature / pressure value in defrost mode that corresponds to relay output operation in ON configured as the 1st condensation fan speed step.	-50.0 -58 0.0 0	110 230 50.0 725	°C °F Bar Psi	Dec int Dec int
FA43	Not used				
FA44	Not used				
Anti-freeze heaters – support					
Parameter	Description	min	max	um	Resolution
Ar 1	Antifreeze/support heaters (air/air units) set point in chiller mode. The temperature value below which the heaters start up.	-50.0 -58	110 230	°C °F	Dec int
Ar 2	Anti-freeze/support heaters band regulation in chiller mode	0.1 1	25.0 45	°C °F	Dec int
Ar 3	Antifreeze/support heaters (air/air units) set point in heat pump mode The temperature value below which the heaters start up.	-50.0 -58	110 230	°C °F	Dec int
Ar 4	Anti-freeze/support heaters band regulation in heat pump mode	0.0 1	25.0 45	°C °F	Dec int
Ar 5	Anti-freeze/support heaters operation in defrosting mode 0 = activated according to temperature control demand 1 = activated according to temperature control demand and during defrost cycle	0	1		
Ar 6	Anti-freeze/support heaters alarm temperature control probe in chiller mode 0 = disabled 1 = evaporator input 2 = evaporator output 1 3 = evaporator output 2 4 = evaporator output 1 / 2 5 = evaporator output 1 / 2 and common output	0	5		

Ar 7	Anti-freeze/support heaters temperature control probe in heat pump mode 0 = disabled 1 = evaporator input 2 = evaporator output 1 3 = evaporator output 2 4 = evaporator output 1 / 2 5 = evaporator output 1 / 2 and common output	0	5		
Ar 8	Condenser anti-freeze heaters temperature control probe 0 = disabled 1 = common condenser water input probe 2 = common condenser water input probe and condenser input 1 3 = common condenser water input probe and condenser input 2 4 = condenser water output probe 1 5 = condenser water output probe 2 6 = condenser output 1 / 2 7 = condenser output 1 / 2 and common output	0	7		
Ar 9	Determines the evaporator/condenser anti-freeze heaters function if a probe that is set to control them malfunctions 0 = OFF if the probe malfunctions 1 = ON if the probe malfunctions	0	1		
Ar 10	Determines the anti-freeze heaters operation when the device is in chiller or heat pump mode. 0 = always OFF (chiller and h.p.) 1 = ON only in chiller mode, depending on the temperature control request 2 = ON only in h.p. mode, depending on the temperature control request 3 = ON in chiller and h.p. mode, depending on the temperature control request	0	3		
Ar 11	Determines the evaporator/condenser anti-freeze heaters operation depending on the remote Off Stand-by mode 0 = Always OFF 1 = ON via temperature control	0	1		
Defrost					
Parameter	Description	min	max	um	Resolution
dF 1	Defrost mode: 0 = defrost disabled 1 = temperature / pressure 2 = starts according to the value of parameter dF28 and ends according to the time 3 = starts according to the value of parameter dF28 and ends due to an external contact 4 = with a condensation fan	0	4		
dF 2	Defrost begins by temperature/pressure	-50.0 -58 0.0 0	110 230 50.0 725	°C °F bar psi	Dec int Dec Int
dF 3	Defrost ends by temperature/pressure	-50.0 -58 0.0 0	110 230 50.0 725	°C °F bar psi	Dec int Dec Int
dF 4	Minimum defrost duration	0	250	Sec	
dF 5	Maximum defrost duration	1	250	Min	
dF 6	Defrost delay between two circuits	0	250	Min	
dF 7	Idle time in compressor OFF mode before defrosting	0	250	Sec	
dF 8	Idle time in compressor OFF mode after defrosting	0	250	Sec	
dF 9	Defrost interval in the same circuit	1	99	Min	
dF 10	Defrosting cycle start temperature setting together with circuit 1 after the count of parameter dF09 elapses	-50.0 -58	110 230	°C °F	Dec Int
dF 11	Defrosting cycle start temperature setting together with circuit 2 after the count of parameter dF09 elapses	-50.0 -58	110 230	°C °F	Dec Int
dF 12	Not used				
dF 13	Not used				
dF 14	End temperature setting of circuit 1 with defrost cycle The actual defrost cycle on circuit 1 terminates when the temperature sensed by the combined defrost temperature probe exceeds the dF14 limit.	-50.0 -58	110 230	°C °F	Dec int
dF 15	End temperature setting of circuit 2 with defrost cycle	-50.0 -58	110 230	°C °F	Dec int
dF 16	Not used				
dF 17	Not used				
dF 18	Forcing by switching ON activates all steps in defrosting mode in circuit 1 0 = disabled 1 = enabled	0	1		
dF 19	Forcing by switching ON activates all steps in defrosting mode in circuit 2	0	1		

dF 20	Not used				
dF 21	Not used				
dF 22	ON delay between two compressors in defrosting mode	1	250	Sec	
dF 23	Fan ON activation during defrosting/dripping 0 = disabled 1 = enabled only during defrost 2 = enabled during defrosting/dripping	0	2		
dF 24	Temperature/pressure setting that forces the fan ON in defrosting mode	-50.0 -58 0.0 0	110 230 50.0 725	°C °F bar psi	Dec int Dec Int
Defrost with condensation fans					
dF 25	Defrost activation setting with condensation fans The function defrost with outdoor fans is enabled if the external temperature is above the dF25 level.	-50.0 -58	110 230	°C °F	Dec int
Defrost Start/Stop					
dF 26	Defrosting cycle start in unit 0 = independent 1 = if both have reached the request for defrosting to start 2 = if at least one has reached the request for defrosting to start	0	2		
dF 27	Defrosting cycle end in unit 0 = independent 1 = if both have reached the defrost end status 2 = if at least one has reached the defrost end status	0	2		
Begin end defrost from analog input					
dF 28	Probe that determines the defrost start and end 0= start and end with condensation temperature / pressure probe 1= start with evaporation pressure probe - end with condensation temperature / pressure probe 2= start with condensation temperature / pressure probe - end with evaporation pressure probe 3= start and end by evaporation pressure 4=start and end by auxiliary probe 1	0	4		
Forced defrost					
dF 29	Minimum idle time before forced defrosting The device wait the delay time dF29 before starting a forced defrost cycle after the relevant conditions have reached	0	250	Sec	
dF 30	Forced defrosting temperature/pressure setting	-50.0 -58 0.0 0	110 230 50.0 725	°C °F bar psi	Dec int Dec Int
dF 31	Forced defrosting differential	0.1 1 0.1 1	25.0 45 14.0 203	°C °F Bar Psi	Dec int Dec int
Supply fan working in defrost mode					
dF 32	Supply fan block in defrosting mode 0 = Not enabled – Supply fan works during defrost 1 = Enabled – Supply fan doesn't work during defrost	0	1		
Anti-freeze security for multi circuit units					
dF 33	Forcing circuits that are not defrosting ON 0 –function is disabled 1 –function is enabled with the fan off 2 –function is enabled with fan controlled by HP circuit	0	2		
Heat recovery					
Parameter	Description	min	max	um	Resolution
rC 1	Recovery function 0 = Disabled 1 = separate hydraulic circuits 2 = hydraulic circuits in parallel 3 = total recovery gas side	0	3		
rC 2	Choice of recovery function priority 0 = user side 1 = recovery side	0	1		
rC 3	Forced step deactivation time	0	250	Sec	
rC 4	Forced step deactivation time after rotation of recovery valve	0	250	Sec	
rC 5	Minimum operation time in recovery mode Minimum activation time of heat recovery function once enabled	0	250	Min	
rC 6	Minimum delay between recovery end and next recovery Minimum time between disabling and following reactivation of heat recovery function	0	250	Min	

rC 7	Recovery function disabling setting Condensing pressure/temperature level for disabling heat recovery function If the condensing pressure exceeds the rC07 level the heat recovery function is automatically disabled.	-50.0 -58 0.0 0	110 230 50.0 725	°C °F Bar Psi	Dec int Dec Int
rC 8	Recovery function enabling differential Heat recovery function is reactivated if the condensing pressure/temperature drops below the rC07 – rC08 level	0.1 1 0.1 1	25.0 45 14.0 203	°C °F Bar Psi	Dec int Dec Int
rC 9	Maximum condensation pressure / temperature recovery disabling time After expiration of the rC09 delay the heat recovery function is reactivated regardless the condensing pressure/temperature level.	0	250	Min	
rC 10	Condensation ventilation operation in recovery mode 0 = enabled 1 = not enabled	0	1		
rC 11	Minimum recovery setting Defines the minimum limit for the working set-point in heat recovery mode	-50.0 -58	rC12	°C °F	Dec Int
rC 12	Maximum recovery setting Defines the maximum limit for the working set-point in heat recovery mode	rC11	110 230	°C °F	Dec Int
rC 13	Recovery set point Defines the working set-point for heat recovery function (active only in cooling mode)	rC11	rC12	°C/°F	Dec / int
rC 14	Recovery differential Defines the working set-point for heat recovery function	0.1 0	25.0 45	°C °F	Dec Int
rC 15	Defines the temperature control probe of the machine in recovery mode 0 = condenser water common inlet 1 = circuit 1 condenser water input NTC 2 = circuit 2 condenser water input NTC 3 = circuit 1 condenser water output NTC 4 = circuit 2 condenser water output NTC 5 = condenser water common output NTC	0	5		

Function for production of domestic hot water

Parameter	Description	min	max	um	Resolution
FS 1	Activation of domestic hot water production 0 = Disabled 1 = with common return – User and domestic hot water heat exchanger and water piping are physically the same 2 = with dedicated return – User and domestic hot water heat exchanger and water piping are physically separated	0	2		
FS 2	Operation priorities 0 = domestic water 1 = heating / cooling	0	1		
FS 3	Domestic water set point. Defines the working set point for the production of domestic hot water.	FS05	FS06	°C °F	dec int
FS 4	Domestic water regulation steps intervention band	0.1 1	25.0 45	°C °F	dec int
FS 5	Minimum domestic water set point value. Minimum limit for the domestic water set point	-50.0 -58	FS06	°C °F	dec int
FS 6	Maximum domestic water set point value. Maximum limit for the domestic water set point	FS05	110 230	°C °F	dec int
FS 7	Activation of the steps to reach the domestic water set point 0 = activates all the compressors 1 = activates the compressors and heaters	0	1		
FS 8	Connection of the domestic water temperature control heaters 0 = no 1 = yes	0	1		
FS 9	Time to activate maximum power/heaters insertion Delay time from domestic hot water production and electric heaters activation for reaching the domestic hot water set point	0	250	min	
FS 10	Delay in activating outputs for domestic water production	0	999	sec	
FS 11	Delay in cycle inversion during domestic water production	0	999	sec	
FS 12	Type of Anti-legionella activation 0 = timed. The antilegionella cycle is activated every FS13 time period. 1 = time band. The antilegionella cycle occurs on the day defined on FS18 and hour defined on FS17	0	1		
FS 13	Delay between two Anti-legionella production cycles. 0 = function disabled	0	250	Hr	
FS 14	Anti legionella set point.	FS15	FS16	°C °F	dec int
FS 15	Minimum Anti-legionella set point value	-50.0 -58	FS16	°C °F	dec int
FS 16	Maximum Anti-legionella set point value	FS15	110 230	°C °F	dec int
FS 17	Anti-legionella activation time	0.00	24.00	Hr	10 min

FS 18	Day of activation Anti-legionella 0 = Disabled 1 = Sunday... 7 = Saturday	0	7		
FS 19	Time in anti-legionella production Once reached the antilegionella set point the antilegionella function is kept active for the FS19 time.	0	250	min	
FS 20	Maximum idle time in Anti-legionella mode The antilegionella cycle is disabled after the time FS20 even though the working set point is not achieved.	0	250	min	
FS 21	Heaters OFF band in Anti-legionella mode The electric heaters activated for the antilegionella function are disabled (before expiration of FS20) if the water temperature exceeds FS14 (antilegionella set)+FS21	0.1 1	25.0 45	°C °F	dec int
FS 22	Water set point for solar panel integration	FS24	FS25	°C °F	dec int
FS 23	Intervention band for solar panel integration.	0.1 1	25.0 45	°C °F	Dec int
FS 24	Solar panel water minimum setting	-50.0 -58	FS25	°C °F	Dec int
FS 25	Solar panel water maximum setting	FS24	110 230	°C °F	Dec int
FS 26	Domestic water output inversion delay from when the domestic water pump is activated	0	250	sec	
FS 27	Domestic water pump deactivation delay from when the domestic water output is inverted	0	250	sec	
FS 28	Domestic water pump operation mode 0 = operation on demand. The pump is activated only when domestic hot water is required. 1 = continuous operation. The pump is always active when the unit is active. FS26 and FS27 delays are ignored	0	1		
FS 29	Minimum interruption (time) during domestic water production by probe no. 2 and minimum time between two interruptions	0	250	sec	
FS 30	Domestic water probe set point no. 2 to interrupt domestic water production	-50.0 -58	110 230	°C °F	dec int
FS 31	Domestic water probe differential no. 2 to interrupt domestic water production	0.1 1	25.0 45	°C °F	dec int
FS 32	Overheating set point to activate the charge modulating valve. After activation of the cooling + sanitary water function the circuit charge modulating valve is activated if the superheating is higher than FS32	-50.0 -58	110 230	°C °F	dec int
FS 33	Overheating band for the charge modulating valve	0.1 1	25.0 45	°C °F	dec int
FS 34	Maximum charge modulating valve time	1	250	min	10 min
FS 35	Water set point to change activation setting and band of the charge modulating valve	-50.0 -58	110 230	°C °F	dec int
FS 36	Water band to change activation setting and band of the charge modulating valve	0.1 1	25.0 45	°C °F	dec int
FS 37	New overheating set point	-50.0 -58	110 230	°C °F	dec int
FS 38	New overheating band	0.1 1	25.0 45	°C °F	dec int
FS 39	Charge modulating valve ON time	1	250	sec	
FS 40	Charge modulating valve OFF time	1	250	sec	
FS 41	Condensation fan forced ON during the production of domestic water 0 = function is disabled 1 = during the FS26 time, the ventilation modulates according to the condensing temperature/pressure 2 = during the FS26 time, the ventilation is forced to operate at the night function speed	0	2		
FS 42	Low condensing temperature/pressure threshold to by-pass the ON time of the domestic water pump before the commutation of the valves. If the condensing pressure/temperature drops below the FS42 level during outdoor fans forced activation the same is disabled	-50.0 -58 0.0 0	110 230 50.0 725	°C °F Bar Psi	dec int dec int
FS 43	Low evaporating pressure threshold to bypass the ON time of the domestic water pump before the commutation of the valves. If the evaporating pressure/temperature drops below the FS42 level during outdoor fans forced activation the same is disabled	-50.0 -58 0.0 0	110 230 50.0 725	°C °F Bar Psi	dec int dec int
FS 44	Evaporator anti-freeze prevention during domestic water production with a single-circuit machine. 0= function is disabled 1=function is enabled For preventing for possible antifreeze alarms due to defrost cycles, if the evaporator water outlet temperature drops below the value defined on parameter FS45 and the external temperature is lower than FS47 the unit is switched to heating function until the water temperature goes higher than FS45+FS46	0	1		

FS 45	Evaporator outlet water set point to prevent anti-freeze	-50.0 -58	110 230	°C °F	dec int
FS 46	Band to prevent anti-freeze	0.1 1	25.0 45	°C °F	dec int
FS 47	External air set point to prevent anti-freeze	-50.0 -58	110 230	°C °F	dec int
FS 48	Do not turn the valves in production of domestic water only with dedicated return. 0= function is disabled 1=function is enabled If the function is active during production of domestic hot water only (no cooling or heating demand) the solenoid valves remain in their standard position and only the domestic hot water pump is activated.	0	1		
FS 49	Switch off evaporator water pump in production of domestic water only with dedicated return. 0= function is disabled 1=function is enabled If the function is active during production of domestic hot water only (no cooling or heating demand) the evaporator pump is switched OFF.	0	1		
FS 50	Overlapping time between evaporator water pump and domestic water pump. If the evaporator water pump is disabled during domestic hot water production only (FS49=1) it is switched OFF FS50 seconds after the activation of the domestic hot water pump	0	250	sec	
FS 51	Standby time before switching inversion valves from chiller to heat pump .Delay time before actual begin of a domestic hot water production	0	250	sec	
FS 52					
FS 53	Minimum operation time in chiller mode before switching to domestic water production. In case of demand of both domestic hot water and cooling the unit is forced to work for FS53 in cooling mode only to ensure enough refrigerant is stored in the condenser.	0	250	sec	10 sec
FS 54	Minimum chiller demand threshold (power steps) before starting in chiller + domestic water mode. Defines the number of cooling demand capacity steps necessary for activation of cooling + domestic hot water production. In case the domestic hot water production function is active any cooling demand for less than the number of steps defined on FS54 is neglected.	1	16		
FS 55	Minimum heat pump demand threshold (power steps) before stopping the domestic water production (with HP priority). In case the domestic hot water production function is active any heating demand for less than the number of steps defined on FS55 is neglected.	1	16		
FS 56	Power modulation if the user side and domestic water side are demanded simultaneously. 0 = the temperature control satisfies the domestic water demand 1 = enabling of max number of steps between domestic water and user side 2 = 100% enabling of power available (only HP)	0	2		
Free-cooling					
Parameter	Description	min	max	um	Resolution
FC 1	Activation of free cooling 0 = Disabled 1 = enabled fan control with condensing priority 2 = enabled fan control priority with free cooling priority 3 = enabled with external free cooling ventilation 4 = enabled in water/water unit	0	4		
FC 2	Free cooling mode input/output differential The FC function is enabled if the external temperature drops at least FC02 below the evaporator inlet water temperature for at least FC03	0.1 1	25.0 45	°C °F	Dec int
FC 3	Free cooling input/output delay	0	250	sec	10 sec
FC 4	Damper closing/3-way water valve differential/free cooling ON-OFF relay with temperature control being satisfied	0.1 1	25.0 45	°C °F	Dec int
FC 5	Band regulation steps/ventilation modulating output in free cooling mode	0.1 1	25.0 45	°C °F	Dec int
FC 6	Regulation steps/ventilation modulating output in free cooling mode 0 = 100% on demand 1 = with step/proportional regulation	0	1		
FC 7	Anti-freeze prevention setting with unit in free cooling mode	-50.0 -58	110 230	°C °F	Dec int
FC 8	Free cooling anti-freeze alarm prevention differential	0.1 1	25.0 45	°C °F	Dec int
FC 9	Minimum operation speed of the fans in free cooling mode	0	100	%	
FC 10	Maximum operation speed of the fans in free cooling mode	0	100	%	
FC 11	Peak time at maximum speed after switch-on	0	250	sec	

FC 12	Circuit 1 - 2 1st step split coil setting	-50.0 -58 0.0 0	110 230 50.0 725	°C °F Bar Psi	Dec int Dec int
FC 13	Circuit 1 - 2 1st step split coil differential	0.1 1 0.1 1	25.0 45 14.0 203	°C °F Bar Psi	Dec int Dec int
FC 14	Circuit 1 - 2 2nd step split coil setting	-50.0 -58 0.0 0	110 230 50.0 725	°C °F Bar Psi	Dec int Dec int
FC 15	Circuit 1 - 2 2nd step split coil differential	0.1 1 0.1 1	25.0 45 14.0 203	°C °F Bar Psi	Dec int Dec int
FC 16	Delay for valve exchange of the split coils	0	250	sec	
FC 17	Outside Set point temperature air for free cooling enable	-50.0 -58	110 230	°C °F	Dec int
FC 18	Condenser water temperature set point for activation free cooling FC	-50.0 -58	110 230	°C °F	Dec int
FC 19	Delayed activation of the water probe condenser FC free cooling	0	250	sec	
FC 20	Delay switching on / off valves free cooling	0	250	sec	
FC 21	Free cooling set point	-50.0 -58	110 230	°C °F	Dec int
FC 22	Free cooling differential	0.1 1	25.0 45	°C °F	Dec int
FC 23	Free cooling delay for the end	0	250	sec	
FC 24	Delay for the activation of preventing frost free cooling	0	250	sec	
FC 25	Free cooling setpoint valve in chillers	-50.0 -58	110 230	°C °F	Dec int
FC 26	Differential valve free cooling in chiller	0.1 1	25.0 45	°C °F	Dec int
FC 27	Free cooling valve regulation minimum percentage	0	FC28	%	
FC 28	Free cooling valve regulation maximum percentage	FC27	100	%	
FC 29	Maintaining minimum valve opening 0 = no 1 = yes	0	1		
FC 30	Time to force the Free Cooling starting after start-up (0=function disabled)	0	250	sec	10 sec
FC 31	Set temperature external air to force the Free Cooling status during the start up	-50.0 -58	ST01	°C °F	Dec int
Auxiliary relays menu					
Parameter	Description	min	max	um	Resolution
Auxiliary relay n° 1					
US 1	Auxiliary relay 1 operation 0 = not enabled 1 = always enabled with direct action 2 = enabled with direct action only with the unit ON 3 = always enabled with inverse action 4 = enabled with inverse action only with the unit ON	0	4		
US 2	Analogue input configuration for control of the auxiliary relay 1	1	36		
US 3	Set point of auxiliary relay 1	-50.0 -58 0.0 0	110 230 50.0 725	°C °F Bar Psi	Dec int Dec Int
US 4	Auxiliary relay 1 differential	0.1 1 0.1 1	25.0 45 14.0 203	°C °F Bar Psi	Dec int Dec Int
Auxiliary relay n° 2					
US 5	Auxiliary relay 2 operation 0 = not enabled 1 = always enabled with direct action 2 = enabled with direct action only with the unit ON 3 = always enabled with inverse action 4 = enabled with inverse action only with the unit ON	0	4		
US 6	Analogue input configuration for control of the auxiliary relay 2	1	36		
US 7	Set point of auxiliary relay 2	-50.0 -58 0.0 0	110 230 50.0 725	°C °F Bar Psi	Dec int Dec Int

US 8	Auxiliary relay 2 differential	0.1	25.0	°C	Dec
		1	45	°F	int
		0.1	14.0	Bar	Dec
		1	203	Psi	Int
Auxiliary relay n° 3					
US 9	Auxiliary relay 3 operation 0 = not enabled 1 = always enabled with direct action 2 = enabled with direct action only with the unit ON 3 = always enabled with inverse action 4 = enabled with inverse action only with the unit ON	0	4		
US 10	Analogue input configuration for control of the auxiliary relay 3	1	36		
US 11	Set point of auxiliary relay 3	-50.0	110	°C	Dec
		-58	230	°F	int
		0.0	50.0	Bar	Dec
		0	725	Psi	Int
US 12	Auxiliary relay 3 differential	0.1	25.0	°C	Dec
		1	45	°F	int
		0.1	14.0	Bar	Dec
		1	203	Psi	Int
Auxiliary relay n° 4					
US 13	Auxiliary relay 4 operation 0 = not enabled 1 = always enabled with direct action 2 = enabled with direct action only with the unit ON 3 = always enabled with inverse action 4 = enabled with inverse action only with the unit ON	0	4		
US 14	Analogue input configuration for control of the auxiliary relay 4	1	36		
US 15	Set point of auxiliary relay 4	-50.0	110	°C	Dec
		-58	230	°F	int
		0.0	50.0	Bar	Dec
		0	725	Psi	Int
US 16	Auxiliary relay 4 differential	0.1	25.0	°C	Dec
		1	45	°F	int
		0.1	14.0	Bar	Dec
		1	203	Psi	Int
Auxiliary proportional output n°1 (0÷10V DC)					
US 17	Proportional auxiliary output 1 operation 0 = not enabled 1 = always enabled with direct action 2 = enabled with direct action only with the unit ON 3 = always enabled with inverse action 4 = enabled with inverse action only with the unit ON	0	4		
US 18	Analogue input configuration for control of the proportional auxiliary relay 1	1	36		
US 19	Set point of proportional auxiliary output 1	-50.0	110	°C	Dec
		-58	230	°F	int
		0.0	50.0	Bar	Dec
		0	725	Psi	Int
US 20	Differential of proportional auxiliary output 1	0.1	25.0	°C	Dec
		1	45	°F	int
		0.1	14.0	Bar	Dec
		1	203	Psi	Int
US 21	Minimum value for 0-10V analogue 1 output	0	US22	%	
US 22	Maximum value for 0-10V 1 analogue 1 output	US21	100	%	
US 23	Analog output 1 maintaining minimum value 0 = no 1 = yes	0	1		
Auxiliary proportional output n°2 (0÷10V DC)					
US 24	Proportional auxiliary output 2 operation 0 = not enabled 1 = always enabled with direct action 2 = enabled with direct action only with the unit ON 3 = always enabled with inverse action 4 = enabled with inverse action only with the unit ON	0	4		
US 25	Analogue input configuration for control of the proportional auxiliary relay 2	1	36		
US 26	Set point of proportional auxiliary output 2	-50.0	110	°C	Dec
		-58	230	°F	int
		0.0	50.0	Bar	Dec
		0	725	Psi	Int
US 27	Differential of proportional auxiliary output 2	0.1	25.0	°C	Dec
		1	45	°F	int
		0.1	14.0	Bar	Dec
		1	203	Psi	Int
US 28	Minimum value for 0-10V analogue 2 output	0	US29	%	
US 29	Maximum value for 0-10V 1 analogue 2 output	US28	100	%	

US 30	Analog output 2 maintaining minimum value 0 = no 1 = yes	0	1		
Auxiliary proportional output n°3 (0÷10V DC)					
US 31	Proportional auxiliary output 3 operation 0 = not enabled 1 = always enabled with direct action 2 = enabled with direct action only with the unit ON 3 = always enabled with inverse action 4 = enabled with inverse action only with the unit ON	0	4		
US 32	Analogue input configuration for control of the proportional auxiliary relay 3	1	36		
US 33	Set point of proportional auxiliary output 3	-50.0 -58 0.0 0	110 230 50.0 725	°C °F Bar Psi	Dec int Dec int
US 34	Differential of proportional auxiliary output 3	0.1 1 0.1 1	25.0 45 14.0 203	°C °F Bar Psi	Dec int Dec int
US 35	Minimum value for 0-10V analogue 3 output	0	US36	%	
US 36	Maximum value for 0-10V 1 analogue 3 output	US35	100	%	
US 37	Analog output 3 maintaining minimum value 0 = no 1 = yes	0	1		
Auxiliary proportional output n°4 (0÷10V DC)					
US 38	Proportional auxiliary output 4 operation 0 = not enabled 1 = always enabled with direct action 2 = enabled with direct action only with the unit ON 3 = always enabled with inverse action 4 = enabled with inverse action only with the unit ON	0	4		
US 39	Analogue input configuration for control of the proportional auxiliary relay 4	1	36		
US 40	Set point of proportional auxiliary output 4	-50.0 -58 0.0 0	110 230 50.0 725	°C °F Bar Psi	Dec int Dec int
US 41	Differential of proportional auxiliary output 4	0.1 1 0.1 1	25.0 45 14.0 203	°C °F Bar Psi	Dec int Dec int
US 42	Minimum value for 0-10V analogue 4 output	0	US43	%	
US 43	Maximum value for 0-10V 1 analogue 4 output	US42	100	%	
US 44	Analog output 4 maintaining minimum value 0 = no 1 = yes	0	1		
Alarms					
Parameter	Description	min	max	um	Resolution
Low pressure alarm					
AL 1	Low pressure alarm delay from a digital/analogue input	0	250	Sec	
AL 2	Defines low pressure alarm operation with pump-down enabled 0 = independent from the pump down 1 = blocks the compressors until the pressure switch is disabled 2 = lets the compressors reach peak values	0	2		
AL 3	Low pressure alarm set point from an analogue input	-50.0 -58 -1.0 14	110 230 50.0 725	°C °F bar psi	Dec int Dec int
AL 4	Low pressure alarm differential from an analogue input	0.1 1 0.1 1	25.0 45 14.0 203	°C °F bar psi	Dec int Dec Int
AL 5	Maximum number of interventions per hour of the low pressure alarm from a digital/analogue input. If the number exceeds AL05 the alarm becomes manual reset. Reset is always manual if AL05 = 0 Reset is always automatic if AL05 = 60 Reset moves from automatic to manual if AL05 moves from 1 to 59	0	60		
AL 6	Low temperature / pressure alarm in defrost mode 0 = not enabled 1 = enabled	0	1		
AL 7	Low temperature / pressure alarm delay in defrost mode Delay time between alarm condition occurrence and reaction by device	0	250	Sec	

AL 8	Low temperature/pressure alarm with the unit in remote OFF or Stand-by mode 0 = alarm detection disabled 1 = alarm detection enabled	0	1		
High pressure alarm					
AL 9	High condensing pressure/temperature alarm set point from an analogue input	-50.0 -58 0.0 0	110 230 50.0 725	°C °F bar psi	Dec int Dec Int
AL 10	High condensing pressure/temperature differential from an analogue input	0.1 1 0.1 1	25.0 45 14.0 203	°C °F bar psi	Dec int Dec Int
AL 11	Maximum number of high condensing pressure/temperature interventions per hour from a digital/analogue input. If the number exceeds AL11 the alarm becomes manual reset. Reset is always manual if AL11 = 0 Reset is always automatic if AL11 = 60 Reset moves from automatic to manual if AL11 moves from 1 to 59	0	60		
Oil pressure/level alarm					
AL 12	Low pressure / oil level alarm delay from a digital input	0	250	Sec	
AL 13	Low pressure / oil level alarm input duration from digital input in normal working conditions. After expiration of AL12 the unit waits further AL13 delay before detecting the alarm	0	250	Sec	
AL 14	Low pressure/oil level maximum number of interventions per hour Reset is always manual if AL14 = 0 Reset is always automatic if AL14 = 60 Reset moves from automatic to manual if AL14 moves from 1 to 59	0	60		
AL 15	Oil pressure switch/float alarm with compressor OFF 0 = alarm detection disabled 1 = alarm detection enabled	0	1		
Evaporator flow / supply fan overload alarm working mode					
AL 16	Evaporator flow switch/thermal overload supply fan alarm by-pass by activating the evaporator pump/supply fan	0	250	Sec	
AL 17	Maximum time in evaporator flow switch alarm before switching to manual mode and blocking the evaporator water pump.	0	250	Sec	
AL 18	Evaporator flow switch / thermal overload supply fan input active duration	0	250	Sec	
AL 19	Evaporator flow switch / thermal overload supply fan input not active duration (disabled if the alarm has turned to manual reset)	0	250	Sec	
AL 20	Evaporator flow switch alarm operating logic. If the polarity detection is enabled the alarm occurs if the polarity doesn't change after the pump start regardless the polarity configuration. 0 = polarity control enabled 1 = polarity control disabled	0	1		
Condenser flow alarm working mode					
AL 21	Condenser flow switch operation 0 = disabled 1 = chiller only 2 = heat pump only 3 = chiller and heat pump	0	3		
AL 22	Condenser flow switch alarm delay from when condenser water pump is activated	0	250	Sec	
AL 23	Maximum time in condenser flow switch alarm before switching to manual mode and blocking the condenser water pump	0	250	Sec	
AL 24	Active condenser flow switch input duration	0	250	Sec	
AL 25	Non-active condenser flow switch input duration (disabled if the alarm has turned to manual reset)	0	250	Sec	
AL 26	Condenser flow switch alarm operating logic. If the polarity detection is enabled the alarm occurs if the polarity doesn't change after the pump start regardless the polarity configuration. 0 = polarity control enabled 1 = polarity control disabled	0	1		
Compressors thermal overload alarm					
AL 27	Compressor thermal overload alarm delay at start-up	0	250	Sec	
AL 28	Maximum number of compressor thermal overload interventions per hour Reset is always manual if AL28 = 0 Reset is always automatic if AL28 = 60 Reset moves from automatic to manual if AL28 moves from 1 to 59	0	60		
AL 29	Compressor thermal overload alarm function 0 = blocks the individual compressor 1 = blocks the circuit	0	1		

AL 30	Compressor thermal overload alarm with compressor OFF 0 = alarm detection disabled 1 = alarm detection enabled	0	1		
AL 31	Compressor thermal overload alarm reset password value (see procedures)	0	999		
Antifreeze / Low room air temperature / Low outlet air temperature alarm working in cooling mode					
AL 32	Anti-freeze minimum set point limit in chiller mode	-50.0 -58	AL33	°C °F	Dec int
AL 33	Anti-freeze maximum set point limit in chiller mode	AL32	110 230	°C °F	Dec int
AL 34	Chiller anti-freeze alarm setting Defines the temperature value below which the antifreeze / low room air temperature / low outlet air temperature alarm is activated	AL32	AL33	°C/°F	Dec / int
AL 35	Anti-freeze alarm differential in chiller-low environmental air temperature-low air temperature output	0.1 1	25.0 45	°C °F	Dec int
AL 36	Alarm delay anti-freeze -low environmental air temperature-low air temperature output in chiller mode. Delay on activation of the antifreeze / low room air temperature / low outlet air temperature alarm from the occurrence of the alarm condition (temperature below alarm set point)	0	250	Sec	
AL 37	Maximum number of interventions per hour of the anti-freeze-low environmental air temperature in chiller mode alarm. Defines the maximum number of antifreeze / low room air temperature / low outlet air temperature alarms per hour. When this number is exceeded the alarm moves from automatic to manual reset. Reset is always manual if AL37 = 0 Reset is always automatic if AL37 = 60 Reset moves from automatic to manual if AL37 moves from 1 to 59	0	60		
AL 38	Anti-freeze alarm operation in chiller mode 0 = it switches off ONLY the compressors, indicates the alarm but does not trigger the buzzer or the alarm relay 1 = shuts off compressors and activates the buzzer and alarm relay	0	1		
Antifreeze alarm working in heating mode					
AL 39	Anti-freeze minimum set point limit in heat pump mode	-50.0 -58	AL40	°C °F	Dec int
AL 40	Anti-freeze maximum set point limit in heat pump mode	AL39	110 230	°C °F	Dec int
AL 41	Anti-freeze alarm setting in heat pump mode	AL39	AL40	°C/°F	Dec / int
AL 42	Anti-freeze alarm differential in heat pump-low environmental air temperature-low air temperature output	0.1 1	25.0 45	°C °F	Dec int
AL 43	Anti-freeze alarm delay when unit starts in heat pump mode Warning In case of alarm condition (control probe temperature lower than AL41) in Stand-by or remote OFF status and AL43 not zero, if the unit is activated in heating mode the antifreeze condition is neglected in order to allow the compressors to start at least for the delay AL43 as the unit heats-up the water or the air. On expiry of the AL43 delay time, if the antifreeze condition is still active the AL44 counter is activated.	0	250	Sec	
AL 44	Alarm delay of the anti-freeze-low environmental air temperature-low air temperature output in normal operation in heat pump mode.	0	250	Sec	
AL 45	Maximum number of interventions per hour of the anti-freeze-low environmental air temperature in heat pump mode alarm. When this number is exceeded the alarm moves from automatic to manual reset. Reset is always manual if AL45 = 0 Reset is always automatic if AL45 = 60 Reset moves from automatic to manual if AL45 moves from 1 to 59	0	60		
AL 46	Anti-freeze alarm operation in heat pump mode 0 = it switches off ONLY the compressors, indicates the alarm but does not trigger the buzzer or the alarm relay 1 = shuts off compressors and activates the buzzer and alarm relay	0	1		
Control probe for antifreeze alarm					
AL 47	Anti-freeze temperature control probe alarm in chiller mode 0 = disabled 1 = evaporator input 2 = evaporator output 1 3 = evaporator output 2 4 = evaporator output 1 / 2 5 = evaporator output 1 / 2 and common output	0	5		
AL 48	Anti-freeze temperature control probe alarm in heat pump mode 0 = disabled 1 = evaporator input 2 = evaporator output 1 3 = evaporator output 2 4 = evaporator output 1 / 2 5 = evaporator output 1 / 2 and common output	0	5		

AL 49	Condenser anti-freeze temperature control probe alarm 0 = disabled 1 = common condenser water input probe 2 = common condenser water input probe and condenser input 1 3 = common condenser water input probe and condenser input 2 4 = condenser water output probe 1 5 = condenser water output probe 2 6 = condenser output 1 / 2 7 = condenser output 1 / 2 and common output	0	7		
Compressors high discharge temperature					
AL 50	Compressor high discharge temperature alarm setting	-50 -58	150 302	°C °F	Dec / Int
AL 51	Compressor high discharge temperature alarm differential	0.1 1	25.0 45	°C °F	Dec Int
AL 52	Maximum number of compressor high discharge temperature alarm interventions per hour When this number is exceeded the alarm moves from automatic to manual reset. Reset is always manual if AL52 = 0 Reset is always automatic if AL52 = 60 Reset moves from automatic to manual reset if AL52 moves from 1 to 59	0	60		
Unit general block alarm n°1					
AL 53	Maximum number of unit general block alarm interventions per hour. Reset is always manual if AL53 = 0 Reset is always automatic if AL53 = 60 Reset moves from automatic to manual reset if AL53 moves from 1 to 59	0	60		
AL 54	Unit general block alarm delay with digital input activated	0	250	Sec	
AL 55	Unit general block alarm delay with digital input deactivated	0	250	10 Sec	10 sec
Unit general block alarm n° 2					
AL 56	General alarm no. 2 operation 0 = only signals; it does not depend on AL57 (alarm relay and buzzer activated); always resets automatically 1 = the alarm blocks the unit; alarm reset depends on the value of par AL57	0	1		
AL 57	Maximum number of unit general block alarm no. 2 interventions per hour When this number is exceeded the alarm moves from automatic to manual reset. Reset is always manual if AL57 = 0 Reset is always automatic if AL57 = 60 Reset moves from automatic to manual reset if AL57 moves from 1 to 59	0	60		
AL 58	Unit general block alarm no. 2 delay with digital input activated	0	250	Sec	10 sec
AL 59	Unit general block alarm no. 2 delay with digital input deactivated	0	250	Sec	10 sec
Evaporator inlet high temperature alarm					
AL 60	Maximum number of system input high water temperature probe alarm interventions per hour Reset is always manual if AL60 = 0 Reset is always automatic if AL60 = 60 Reset moves from automatic to manual if AL60 moves from 1 to 59	0	60		
AL 61	System input high water temperature probe alarm delay from compressor activation	0	250	Sec	10 sec
AL 62	System input high water temperature probe alarm set point	-50.0 -58	110 230	°C °F	Dec Int
AL 63	System input high water temperature probe alarm differential	0.1 1	25.0 45	°C °F	Dec Int
AL 64	NTC/PTC analogue input configuration for control of the system input high water temperature alarm 0 = function disabled	0	51		
Alarm relay					
AL 65	Activation of the alarm relay output in remote OFF or Stand-by mode 0 = alarm output enabled 1 = alarm output disabled	0	1		
AL 66	Alarm log reset password (see procedure)	0	999		
Anti-freeze alarm in free cooling					
AL 67	Alarm delay from signal frost in free cooling.	0	250	Sec	
AL 68	Maximum number hours alarm frost interventions in free cooling	0	60		
Auxiliary heating alarms					
AL 69	Compressor status in case in heating auxiliary alarm 0 = Keep Off 1 = ON again	0	1		
AL 70	Maximum number hours alarm interventions of thermal heaters	0	60		
AL 71	Maximum number interventions alarm time of block heaters	0	60		
Electronic thermostatic driver					
Parameter	Description	min	max	um	Resolution

Et 1	Configuration of probes Pb1 and Pb2 connected to the driver 0 = NTC temperature 1 = PTC temperature 2 = PT1000 temperature	0	2		
Et 2	Configuration of probes Pb3 and Pb4 connected to the driver 0 = NTC temperature 1 = PTC temperature 2 = PT1000 temperature 3 = pressure 4÷20mA 4 = pressure 0÷5V 5 = not present (low pressure defined transducers are used)	0	5		
Et 3	Type of valve: 1 = Unipolar 2 = Bipolar	1	2		
Et 4	Selection of the bipolar valve body connected to the driver (WARNING the unique and valid reference has to be considered the datasheet made by valve manufacturer;) 0 = Custom 1 = Alco EX4 – EX5 – EX6 2 = Alco EX7 3 = Alco EX8 4 = Carel E2V* 5 = Carel E2V*P 6 = Danfoss ETS – 25/50 7 = Danfoss ETS – 100 8 = Danfoss ETS – 250/400 9 = Sporlan SEI 0.5 – 11 10 = Sporlan SEI 30 11 = Sporlan SEH 50/100/175	0	11		
Et 5	Selection of the unipolar valve body connected to the driver 0 = Custom	0	0		
Et 6	Valve driving 0 = drives both valves 1 = drives only valve 1	0	1		
Et 7	Valve 1 output operation mode 0 = chiller 1 = heat pump 2 = chiller and heat pump 3 = not used 4 = not used 5 = not used	0	5		
Et 8	Valve 2 output operation mode 0 = chiller 1 = heat pump 2 = chiller and heat pump 3 = not used 4 = not used 5 = not used	0	5		
Et 9	Selection of output circuit valve 1 driver 1 0 = Not present 1 = Circuit 1 2 = Circuit 2	0	2		
Et 10	Selection of output circuit valve 2 driver 1 0 = Not present 1 = Circuit 1 2 = Circuit 2	0	2		
Et 11	Selection of output circuit valve 1 driver 2 0 = Not present 1 = Circuit 1 2 = Circuit 2	0	2		
Et 12	Selection of output circuit valve 2 driver 2 0 = Not present 1 = Circuit 1 2 = Circuit 2	0	2		
Et 13	Not used				
Et 14	Not used				
Et 15	Not used				
Et 16	Not used				
Et 17	Number of additional steps to achieve complete closure. When a closing request is received, the valve starts from the current number of steps and moves to 0, then closes for the set number of steps	0	250		
Et 18	Number of return steps in opening mode after the valve has been closed completely. These decompress any closing spring inside the valve or to prevent sealing the circuit	0	250		
Et 19	Maximum number of adjusting steps of the valve	Et20	8000		

Et 20	Minimum number of adjusting steps of the valve	0	Et19		
Et 21	Maximum current value per phase of the stepper motor	0	100	mA	x10 mA
Et 22	Current stand-by value	0	100	mA	x10 mA
Et 23	Maximum number of steps per second of the valve	0	600	Hz	
Et 24	Indicates the number of steps the valve has to move before compressor start-up. 0 = function is disabled	0	Et19		
Et 25	Sets valve manual operation mode 0= Automatic 1= Manual	0	1		
Et 26	Absolute number of steps the valve has to move in manual mode	0	Et19		
Et 27	Low pressure alarm activation delay (LOP)	0	250	Sec	
Et 28	High pressure alarm activation delay (MOP)	0	250	Sec	
Et 29	High overheating alarm activation delay	0	250	Sec	10 Sec
Et 30	Low overheating alarm activation delay	0	250	Sec	10 Sec
PID regulation in chiller mode					
Et 31	PID proportional constant in chiller mode	0.0	50.0	°C	Dec
Et 32	PID integral time in chiller mode	0	500	Sec	
Et 33	PID derivative constant in chiller mode	0	250	Sec	
Et 34	Overheating regulation set point during chiller mode	0.0	25.0	°C	dec
Et 35	Overheating regulation dead band in chiller mode	0.0	5.0	°C	dec
Et 36	High overheating threshold. The alarm status is signaled after the high overheating alarm activation delay	Et34	80.0	°C	dec
Et 37	Low overheating threshold. The alarm status is signaled after the low overheating alarm activation delay	0.0	Et34	°C	dec
Et 38	PID proportional constant in defrost if ET7/8 = 3/5	0.0	50.0	°C	dec
Et 39	MOP Protection activation threshold. High evaporating temperature threshold. The alarm status is signaled after the high evaporating temperature alarm activation delay	0.0	50.0	°C	dec
Et 40	STEP RATE during MOP or LOP protection (number of steps every second)	0	ET19		
Et 41	LOP Protection activation threshold. Low evaporating temperature threshold. The alarm status is signaled after the low evaporating temperature alarm activation delay	-50.0	50.0	°C	dec
Et 42	Max Valve Opening in CH mode (percentage)	0	100	%	
Et 43	Min Valve Opening in CH mode (percentage)	0	100	%	
Et 44	Pressure measure Filter in CH mode	1	250	Sec	
Et 45	Interval of updating the valve output in CH mode	0	250	Sec	
Et 46	Delay of alarm in case of probe error in CH mode	0	250	Sec	
Et 47	% of valve during the ET46 time in CH mode	0	100	%	
PID regulation in Heat pump mode					
Et 48	PID proportional constant in HP mode	0.0	50.0	°C	dec
Et 49	PID integral time in HP mode	0	500	Sec	
Et 50	PID derivative constant in HP mode	0	250	Sec	
Et 51	Overheating regulation set point during HP mode	0.0	25.0	°C	dec
Et 52	Overheating regulation dead band in HP mode	0.0	5.0	°C	dec
Et 53	High overheating threshold. The alarm status is signaled after the high overheating alarm activation delay	Et54	80.0	°C	dec
Et 54	Low overheating threshold. The alarm status is signaled after the low overheating alarm activation delay	0.0	Et53	°C	dec
Et 55	PID proportional constant in defrost if ET7/8 = 4	0.0	50.0	°C	Dec
Et 56	MOP Protection activation threshold. High evaporating temperature threshold. The alarm status is signaled after the high evaporating temperature alarm activation delay	0.0	50.0	°C	dec
Et 57	STEP RATE during MOP or LOP protection (number of steps every second)	0	100		
Et 58	LOP Protection activation threshold. Low evaporating temperature threshold. The alarm status is signaled after the low evaporating temperature alarm activation delay	-50.0	50.0	°C	dec
Et 59	Max Valve Opening in HP mode (percentage)	0	100	%	
Et 60	Min Valve Opening in HP mode (percentage)	0	100	%	
Et 61	Pressure measure Filter in HP mode	1	250	Sec	
Et 62	Interval of updating the valve output in HP mode	0	250	Sec	
Et 63	Delay of alarm in case of probe error in HP mode	0	250	Sec	
Et 64	% of valve during the ET46 time in HP mode	0	100	%	
Input/output					
Parameter	Description	min	max	mu	Resolution
Local I/O					
IO 1	Pb1 configuration	0 o1	37 c62		
IO 2	Pb2 configuration	0 o1	37 c62		

IO 3	Pb3 configuration	0 o1	37 c62		
IO 4	Pb4 configuration	0 o1	37 c62		
IO 5	Pb5 configuration	0 o1	37 c62		
IO 6	Pb6 configuration	0 o1	37 c62		
IO 7	Not used				
IO 8	Not used				
IO 9	Not used				
IO 10	Not used				
IO 11	DI1 configuration	0	c62		
IO 12	DI2 configuration	0	c62		
IO 13	DI3 configuration	0	c62		
IO 14	DI4 configuration	0	c62		
IO 15	DI5 configuration	0	c62		
IO 16	DI6 configuration	0	c62		
IO 17	DI7 configuration	0	c62		
IO 18	DI8 configuration	0	c62		
IO 19	DI9 configuration	0	c62		
IO 20	DI10 configuration	0	c62		
IO 21	DI11 configuration	0	c62		
IO 22	Not used				
IO 23	Not used				
IO 24	Not used				
IO 25	Not used				
IO 26	Not used				
IO 27	Not used				
IO 28	Not used				
IO 29	Not used				
IO 30	Not used				
IO 31	RL1 configuration	0	c91		
IO 32	RL2 configuration	0	c91		
IO 33	RL3 configuration	0	c91		
IO 34	RL4 configuration	0	c91		
IO 35	RL5 configuration	0	c91		
IO 36	RL6 configuration	0	c91		
IO 37	RL7 configuration	0	c91		
IO 38	RL8 configuration	0	c91		
IO 39	Not used				
IO 40	Not used				
IO 41	Not used				
IO 42	Not used				
IO 43	Not used				
IO 44	Not used				
IO 45	Not used				
IO 46	AO1 configuration	0 o1	22 c91		
IO 47	AO2 configuration	0 o1	22 c91		
IO 48	AO3 configuration	0 o1	22 c91		
IO 49	AO4 configuration	0 o1	22 c91		
IO 50	Not used				
IO 51	Not used				
XEV I/O					
IO 52	1st XEV Pb1 configuration	0	37		
IO 53	1st XEV Pb2 configuration	0	37		
IO 54	1st XEV Pb3 configuration	0	37		
IO 55	1st XEV Pb4 configuration	0	37		
IO 56	2nd XEV Pb1 configuration	0	37		
IO 57	2nd XEV Pb2 configuration	0	37		
IO 58	2nd XEV Pb3 configuration	0	37		
IO 59	2nd XEV Pb4 configuration	0	37		
IO 60	Not used				
IO 61	Not used				
IO 62	Not used				
IO 63	Not used				
IO 64	Not used				
IO 65	Not used				
IO 66	Not used				

IO 67	Not used				
1st Expansion I/O					
IO 68	1st Expansion Pb1 configuration	0 o1	37 c62		
IO 69	1st Expansion Pb2 configuration	0 o1	37 c62		
IO 70	1st Expansion Pb3 configuration	0 o1	37 c62		
IO 71	1st Expansion Pb4 configuration	0 o1	37 c62		
IO 72	1st Expansion Pb5 configuration	0 o1	37 c62		
IO 73	1st Expansion Pb6 configuration	0 o1	37 c62		
IO 74	1st Expansion Pb7 configuration	0 o1	37 c62		
IO 75	1st Expansion DI1 configuration	0	c62		
IO 76	1st Expansion DI2 configuration	0	c62		
IO 77	1st Expansion DI3 configuration	0	c62		
IO 78	1st Expansion RL1 configuration	0	c91		
IO 79	1st Expansion RL2 configuration	0	c91		
IO 80	1st Expansion RL3 configuration	0	c91		
IO 81	1st Expansion RL4 configuration	0	c91		
IO 82	1st Expansion RL5 configuration	0	c91		
IO 83	1st Expansion RL6 configuration	0	c91		
IO 84	1st Expansion AO1 configuration	0 o1	22 c91		
IO 85	1st Expansion AO2 configuration	0 o1	22 c91		
IO 86	1st Expansion AO3 configuration	0 o1	22 c91		
Analog Input Calibration					
Parameter	Description	min	max	mu	Resolution
Local I/O					
CA 1	Pb1 calibration	-12.0 -21 -5.0 -72	12.0 21 5.0 72	°C °F bar PSI	decimal whole decimal whole
CA 2	Pb2 calibration	-12.0 -21 -5.0 -72	12.0 21 5.0 72	°C °F bar PSI	decimal whole decimal whole
CA 3	Pb3 calibration	-12.0 -21 -5.0 -72	12.0 21 5.0 72	°C °F bar PSI	decimal whole decimal whole
CA 4	Pb4 calibration	-12.0 -21 -5.0 -72	12.0 21 5.0 72	°C °F bar PSI	decimal whole decimal whole
CA 5	Pb5 calibration	-12.0 -21 -5.0 -72	12.0 21 5.0 72	°C °F bar PSI	decimal whole decimal whole
CA 6	Pb6 calibration	-12.0 -21 -5.0 -72	12.0 21 5.0 72	°C °F bar PSI	decimal whole decimal whole
CA 7	Not used				
CA 8	Not used				
CA 9	Not used				
CA 10	Not used				
XEV I/O					
CA 11	1st XEV Pb1 calibration	-12.0 -21	12.0 21	°C °F	decimal whole
CA 12	1st XEV Pb2 calibration	-12.0 -21	12.0 21	°C °F	decimal whole
CA 13	1st XEV Pb3 calibration	-12.0 -21 -5.0 -72	12.0 21 5.0 72	°C °F bar PSI	decimal whole decimal whole

CA 14	1st XEV Pb4 calibration	-12.0	12.0	°C	decimal
		-21	21	°F	whole
		-5.0	5.0	bar	decimal
		-72	72	PSI	whole
CA 15	2nd XEV Pb1 calibration	-12.0	12.0	°C	decimal
		-21	21	°F	whole
CA 16	2nd XEV Pb2 calibration	-12.0	12.0	°C	decimal
		-21	21	°F	whole
CA 17	2nd XEV Pb3 calibration	-12.0	12.0	°C	decimal
		-21	21	°F	whole
		-5.0	5.0	bar	decimal
		-72	72	PSI	whole
CA 18	2nd XEV Pb4 calibration	-12.0	12.0	°C	decimal
		-21	21	°F	whole
		-5.0	5.0	bar	decimal
		-72	72	PSI	whole
CA 19	Not used				
CA 20	Not used				
CA 21	Not used				
CA 22	Not used				
CA 23	Not used				
CA 24	Not used				
CA 25	Not used				
CA 26	Not used				
1st Expansion I/O					
CA 27	1st Expansion Pb1 calibration	-12.0	12.0	°C	decimal
		-21	21	°F	whole
		-5.0	5.0	bar	decimal
		-72	72	PSI	whole
CA 28	1st Expansion Pb2 calibration	-12.0	12.0	°C	decimal
		-21	21	°F	whole
		-5.0	5.0	bar	decimal
		-72	72	PSI	whole
CA 29	1st Expansion Pb3 calibration	-12.0	12.0	°C	decimal
		-21	21	°F	whole
		-5.0	5.0	bar	decimal
		-72	72	PSI	whole
CA 30	1st Expansion Pb4 calibration	-12.0	12.0	°C	decimal
		-21	21	°F	whole
		-5.0	5.0	bar	decimal
		-72	72	PSI	whole
CA 31	1st Expansion Pb5 calibration	-12.0	12.0	°C	decimal
		-21	21	°F	whole
		-5.0	5.0	bar	decimal
		-72	72	PSI	whole
CA 32	1st Expansion Pb6 calibration	-12.0	12.0	°C	decimal
		-21	21	°F	whole
		-5.0	5.0	bar	decimal
		-72	72	PSI	whole
CA 33	1st Expansion Pb7 calibration	-12.0	12.0	°C	decimal
		-21	21	°F	whole
		-5.0	5.0	bar	decimal
		-72	72	PSI	whole
Analog Input Ranges					
Parameter	Description	min	max	mu	Resolution
Local I/O					
RA 1	Pb1 Pressure value at 0,5V / 4mA	-1.0 -14	50.0 725	bar PSI	decimal whole
RA 2	Pb1 Pressure value at 4,5V / 20mA	-1.0 -14	50.0 725	bar PSI	decimal whole
RA 3	Pb2 Pressure value at 0,5V / 4mA	-1.0 -14	50.0 725	bar PSI	decimal whole
RA 4	Pb2 Pressure value at 4,5V / 20mA	-1.0 -14	50.0 725	bar PSI	decimal whole
RA 5	Pb3 Pressure value at 0,5V / 4mA	-1.0 -14	50.0 725	bar PSI	decimal whole
RA 6	Pb3 Pressure value at 4,5V / 20mA	-1.0 -14	50.0 725	bar PSI	decimal whole
RA 7	Pb4 Pressure value at 0,5V / 4mA	-1.0 -14	50.0 725	bar PSI	decimal whole
RA 8	Pb4 Pressure value at 4,5V / 20mA	-1.0 -14	50.0 725	bar PSI	decimal whole
RA 9	Pb5 Pressure value at 0,5V / 4mA	-1.0 -14	50.0 725	bar PSI	decimal whole

RA 10	Pb5 Pressure value at 4,5V / 20mA	-1.0 -14	50.0 725	bar PSI	decimal whole
RA 11	Pb6 Pressure value at 0,5V / 4mA	-1.0 -14	50.0 725	bar PSI	decimal whole
RA 12	Pb6 Pressure value at 4,5V / 20mA	-1.0 -14	50.0 725	bar PSI	decimal whole
RA 13	Not used				
RA 14	Not used				
RA 15	Not used				
RA 16	Not used				
RA 17	Not used				
RA 18	Not used				
RA 19	Not used				
RA 20	Not used				
XEV I/O					
RA 21	1st XEV Pb3 Pressure value at 0,5V / 4mA	-1.0 -14	50.0 725	bar PSI	decimal whole
RA 22	1st XEV Pb3 Pressure value at 4,5V / 20mA	-1.0 -14	50.0 725	bar PSI	decimal whole
RA 23	1st XEV Pb4 Pressure value at 0,5V / 4mA	-1.0 -14	50.0 725	bar PSI	decimal whole
RA 24	1st XEV Pb4 Pressure value at 4,5V / 20mA	-1.0 -14	50.0 725	bar PSI	decimal whole
RA 25	2nd XEV Pb3 Pressure value at 0,5V / 4mA	-1.0 -14	50.0 725	bar PSI	decimal whole
RA 26	2nd XEV Pb3 Pressure value at 4,5V / 20mA	-1.0 -14	50.0 725	bar PSI	decimal whole
RA 27	2nd XEV Pb4 Pressure value at 0,5V / 4mA	-1.0 -14	50.0 725	bar PSI	decimal whole
RA 28	2nd XEV Pb4 Pressure value at 4,5V / 20mA	-1.0 -14	50.0 725	bar PSI	decimal whole
RA 29	Not used				
RA 30	Not used				
RA 31	Not used				
RA 32	Not used				
RA 33	Not used				
RA 34	Not used				
RA 35	Not used				
RA 36	Not used				
1st Expansion I/O					
RA 37	1st Expansion Pb1 Pressure value at 0,5V / 4mA	-1.0 -14	50.0 725	bar PSI	decimal whole
RA 38	1st Expansion Pb1 Pressure value at 4,5V / 20mA	-1.0 -14	50.0 725	bar PSI	decimal whole
RA 39	1st Expansion Pb2 Pressure value at 0,5V / 4mA	-1.0 -14	50.0 725	bar PSI	decimal whole
RA 40	1st Expansion Pb2 Pressure value at 4,5V / 20mA	-1.0 -14	50.0 725	bar PSI	decimal whole
RA 41	1st Expansion Pb3 Pressure value at 0,5V / 4mA	-1.0 -14	50.0 725	bar PSI	decimal whole
RA 42	1st Expansion Pb3 Pressure value at 4,5V / 20mA	-1.0 -14	50.0 725	bar PSI	decimal whole
RA 43	1st Expansion Pb4 Pressure value at 0,5V / 4mA	-1.0 -14	50.0 725	bar PSI	decimal whole
RA 44	1st Expansion Pb4 Pressure value at 4,5V / 20mA	-1.0 -14	50.0 725	bar PSI	decimal whole
RA 45	1st Expansion Pb5 Pressure value at 0,5V / 4mA	-1.0 -14	50.0 725	bar PSI	decimal whole
RA 46	1st Expansion Pb5 Pressure value at 4,5V / 20mA	-1.0 -14	50.0 725	bar PSI	decimal whole
RA 47	1st Expansion Pb6 Pressure value at 0,5V / 4mA	-1.0 -14	50.0 725	bar PSI	decimal whole
RA 48	1st Expansion Pb6 Pressure value at 4,5V / 20mA	-1.0 -14	50.0 725	bar PSI	decimal whole
RA 49	1st Expansion Pb7 Pressure value at 0,5V / 4mA	-1.0 -14	50.0 725	bar PSI	decimal whole
RA 50	1st Expansion Pb7 Pressure value at 4,5V / 20mA	-1.0 -14	50.0 725	bar PSI	decimal whole

10. ANALOGUE - DIGITAL INPUTS/OUTPUTS CONFIGURATIONS

On board of the controller, it allows to configure 11 DI, 8 DO, 6 AI and 4 AO in maximum. If more I/O needed, please use expansion module IPROEX60D. For one IPROEX60D, it can connect with 3 DI, 6 DO, 7 AI and 3 AO. It can has 1 IPROEX60D at most. In addition, 2 electronic thermostatic drivers XEV20D can provide 8 more AI (4 for each).

Use parameters in group IO to configure analogue-digital inputs/outputs.

DIGITAL INPUTS CONFIGURATION

- IO11 – IO21: On board DI (1 - 11)
- IO75 – IO77: 1st expansion DI (1 - 3)

DIGITAL OUTPUTS CONFIGURATION

- IO31 – IO38: On board relays (1 - 8)
- IO78 – IO83: 1st expansion relays (1 - 6)

ANALOGUE INPUTS CONFIGURATION

- IO01 – IO06: On board probes (1 - 6)
- IO52 – IO55: 1st XEV20D probes (1 - 4)
- IO56 – IO59: 2nd XEV20D probes (1 - 4)
- IO68 – IO74: 1st expansion probes (1 - 7)

ANALOGUE OUTPUTS CONFIGURATION

- IO46 – IO49: On board AO (1 - 4)
- IO84 – IO86: 1st expansion AO (1 - 3)

Note:

For digital inputs/outputs, it is possible to select polarity. In I/O configuration, use prefix “o” to indicate “open” polarity which means the DI/DO is activated when contact is open; use prefix “c” to indicate “close” polarity which means the DI/DO is activated when contact is closed.

For example:

IO11 = o1 - Remote ON/OFF

IO11 = c1 - Remote ON/OFF

They all mean DI01 is configured as “Remote ON/OFF” but with different polarity. And the DI type is 1.

In the paragraphs below, we will use “**DI type**”, “**DO type**”, “**AI type**” and “**AO type**” to indicated function index of all the I/O.

For analogue inputs/outputs, it is also possible to configured as digital inputs/outputs. For example an AI can assume values from 0 to 37 (if configured as analog) and from 38 (that correspond to o1) to 161 (that correspond to c62).

Remember that:

- AO1, AO2, AO3 and AO4 can be configured as 0-10V and 4-20mA;
- in the expansions modules, the AO can be configured only as 0-10V.

10.1 DI1 – DI11 DIGITAL INPUTS CONFIGURATION (DI TYPE)

0. Disabled
1. Remote ON/OFF
2. Remote chiller / heat pump
3. Evaporator flow switch
4. Condenser flow switch hot side
5. Domestic water flow switch
6. Antifreeze alarm circuit 1
7. Antifreeze alarm circuit 2
8. High pressure pressure switch circuit 1
9. High pressure pressure switch circuit 2
10. Low pressure pressure switch circuit 1
11. Low pressure pressure switch circuit 2

12. High pressure compressor 1
13. High pressure compressor 2
14. High pressure compressor 3
15. High pressure compressor 4
16. High pressure compressor 5
17. High pressure compressor 6
18. Thermal overload compressor 1
19. Thermal overload compressor 2
20. Thermal overload compressor 3
21. Thermal overload compressor 4
22. Thermal overload compressor 5
23. Thermal overload compressor 6
24. Condensation fan thermal overload circuit 1
25. Condensation fan thermal overload circuit 2
26. Condensation fan thermal overload common 1 / 2
27. Thermal overload water pump 1 evaporator / thermal overload supply fan
28. Evaporator support water pump thermal overload
29. Thermal overload water pump 1 condenser
30. Condenser support water pump thermal overload
31. Request for recovery operation circuit 1
32. Request for recovery operation circuit 2
33. End defrost circuit 1
34. End defrost circuit 2
35. Energy Saving
36. Compressor 1 oil pressure switch/float
37. Compressor 2 oil pressure switch/float
38. Compressor 3 oil pressure switch/float
39. Compressor 4 oil pressure switch/float
40. Compressor 5 oil pressure switch/float
41. Compressor 6 oil pressure switch/float
42. Pump down pressure switch circuit 1
43. Pump down pressure switch circuit 2
44. Digital input general block alarm unit 1
45. Digital input general alarm alert / block unit 2
46. Digital input working in RTC automatic activation (time band)/manual
47. Digital input working with supply fan only
48. Digital input temperature control request (motor-condensing unit)
49. Chiller request digital input (motor-condensing unit)
50. Heat pump request digital input (motor-condensing unit)
51. Digital input power step 1 request (motor-condensing unit)
52. Digital input power step 2 request (motor-condensing unit)
53. Digital input power step 3 request (motor-condensing unit)
54. Digital input power step 4 request (motor-condensing unit)
55. Digital input power step 5 request (motor-condensing unit)
56. Digital input power step 6 request (motor-condensing unit)
57. Digital input power step 7 request (motor-condensing unit)
58. Digital input power step 8 request (motor-condensing unit)
59. Solar panels flow switch
60. Incorrect sequence of phases
61. Auxiliary heating thermal overload
62. Auxiliary heating block

10.2 RL1- RL15 DIGITAL OUTPUTS CONFIGURATION (DO TYPE)

0. Disabled
1. Alarm
2. Evaporator water pump/supply fan
3. Evaporator support water pump
4. Anti-freeze heaters circuit 1
5. Anti-freeze heaters circuit 2
6. Recovery condenser water pump
7. Recovery condenser support water pump
8. Chiller / heat pump inversion valve circuit 1
9. Chiller / heat pump inversion valve circuit 2
10. 1st step ON/OFF condensation fan circuit 1
11. 2nd step ON/OFF condensation fan circuit 1
12. 3rd step ON/OFF condensation fan circuit 1
13. 4th step ON/OFF condensation fan circuit 1
14. 1st step ON/OFF condensation fan circuit 2
15. 2nd step ON/OFF condensation fan circuit 2
16. 3rd step ON/OFF condensation fan circuit 2
17. 4th step ON/OFF condensation fan circuit 2
18. Pump-down solenoid circuit 1
19. Pump-down solenoid circuit 2
20. Recovery valve circuit 1
21. Recovery valve circuit 2
22. Free cooling ON/OFF valve / valve 1 free cooling water-water unit
23. Fan relay output ON/OFF valve / valve 2 free cooling water-water unit
24. 1st step split coil circuit 1
25. 2nd step split coil circuit 1
26. 1st step split coil circuit 2
27. 2nd step split coil circuit 2
28. Auxiliary output n° 1
29. Auxiliary output n° 2
30. Auxiliary output n° 3
31. Auxiliary output n° 4
32. Intermittent valve for screw comp/increase valve for stepless compr. (compressor 1)
33. Intermittent valve for screw comp/increase valve for stepless compr. (compressor 2)
34. Liquid injection solenoid valve compressor 1
35. Liquid injection solenoid valve compressor 2
36. ON/OFF valve 1 for domestic water production
37. ON/OFF valve 2 for domestic water production
38. Heaters (first step) for domestic water production
39. Heaters (second step) for domestic water production
40. Heaters (third step) for domestic water production
41. Solar panel pump
42. Solar coil activation/deactivation ON/OFF valve
43. Domestic water pump
44. Compressor 1 Direct start-up
Compressor 1 Winding 1 Part Winding start-up
Compressor 1 Line 1 Star Delta start-up
45. Compressor 1 Winding 2 Part Winding start-up
Compressor 1 Line 2 Star Delta start-up
46. Compressor 1 Star Delta start-up: Star centre
47. Compressor 1 Unloader 1
48. Compressor 1 Unloader 2
49. Compressor 1 Unloader 3
50. Compressor 1 gas by-pass valve during start-up
51. Compressor 2 Direct start-up
Compressor 2 Winding 1 Part Winding start-up
Compressor 2 Line 1 Star Delta start-up
52. Compressor 2 Winding 2 Part Winding start-up
Compressor 2 Line 2 Star Delta start-up

53. Compressor 2 Star Delta start-up: Star centre
54. Compressor 2 Unloader 1
55. Compressor 2 Unloader 2
56. Compressor 2 Unloader 3
57. Compressor 2 gas by-pass valve during start-up
58. Compressor 3 Direct start-up
59. Compressor 4 Direct start-up
60. Compressor 5 Direct start-up
61. Compressor 6 Direct start-up
62. Circuit 1 charge modulating valve
63. Circuit 2 charge modulating valve
64. Operating unit
65. APS Alarm (phase sequence)
66. HP1 Alarm
67. HP2 Alarm
68. LP1 Alarm
69. LP2 Alarm
70. AEFL Alarm
71. ACFL Alarm
72. AHFL Alarm
73. APFL Alarm
74. ALC1 Alarm
75. ALC2 Alarm
76. C1tr Alarm
77. C2tr Alarm
78. C3tr Alarm
79. C4tr Alarm
80. C5tr Alarm
81. C6tr Alarm
82. B1A Alarm
83. B2A Alarm
84. Auxiliary heating 1st step
85. Auxiliary heating 2nd step
86. Auxiliary heating 3rd step
87. Auxiliary heating 4th step
88. Refcomp Inverter Power
89. IV management valve 14
90. IV management valve 15
91. IV management valve 16

10.3 ANALOGUE INPUTS PB1 - PB10 CONFIGURATION (AI TYPE)

0. Disabled
1. Compressor 1 PTC supply temperature probe
2. Compressor 2 PTC supply temperature probe
3. Compressor 3 PTC supply temperature probe
4. Compressor 4 PTC supply temperature probe
5. Compressor 5 PTC supply temperature probe
6. Compressor 6 PTC supply temperature probe
7. Evaporator common input NTC temperature probe
8. Evaporator 1 output NTC temperature probe
9. Evaporator 2 output NTC temperature probe
10. Evaporator common outlet NTC temperature probe
11. Condenser hot water common input NTC temperature probe
12. Circuit 1 condenser hot water input NTC temperature probe
13. Circuit 2 condenser hot water input NTC temperature probe
14. Circuit 1 condenser hot water output NTC temperature probe
15. Circuit 2 condenser hot water output NTC temperature probe
16. Condenser hot water common output NTC temperature probe
17. System water inlet NTC temperature probe (free-cooling)
18. External air / condenser water (free cooling) temperature NTC temperature probe

19. External air temp / dynamic set point / auxiliary heating / change over NTC temperature probe
20. Circuit n° 1 combined defrost NTC temperature probe
21. Circuit n° 2 combined defrost NTC temperature probe
22. Auxiliary output 1 NTC temperature probe
23. Auxiliary output 2 NTC temperature probe
24. Domestic water temperature regulation NTC temperature probe (num. 1)
25. Domestic water temperature safety NTC temperature probe (num. 2)
26. Supply temperature NTC temperature probe
27. Solar panel NTC temperature probe
28. Circuit 1 condensation probe (NTC temperature)
29. Circuit 2 condensation probe (NTC temperature)
30. Circuit 1 condensation probe (pressure 4÷20 mA / ratiometric 0÷ 5Volt)
31. Circuit 2 condensation probe (pressure 4÷20 mA / ratiometric 0÷ 5Volt)
32. Circuit 1 evaporation pressure probe (pressure 4÷20 mA / ratiometric 0÷ 5Volt)
33. Circuit 2 evaporation pressure probe (pressure 4÷20 mA / ratiometric 0÷ 5Volt)
34. Circuit 1 auxiliary output pressure probe (pressure 4÷20 mA / ratiometric 0÷ 5Volt)
35. Circuit 2 auxiliary output pressure probe (pressure 4÷20 mA / ratiometric 0÷ 5Volt)
36. Dynamic set-point 4÷20 mA probe

Digital input (o1-c62, see relevant configurations)

10.4 CONFIGURATION OF THE OUT1 / OUT4 PROPORTIONAL OUTPUTS (AO TYPE)

0÷10V - 4÷20mA output signal

0. Output disabled
1. proportional output 0÷10V condensation control circuit 1
2. proportional output 0÷10V condensation control circuit 2
3. proportional output 0÷10V damper / mixing valve free cooling direct action
4. 0÷10V hot water three-way valve control 0÷10V proportional output
5. auxiliary output 1 0÷10V
6. auxiliary output 2 0÷10V
7. auxiliary output 3 0÷10V
8. auxiliary output 4 0÷10V
9. modulating output 0÷10V compressor 1 circuit 1
10. modulating output 0÷10V compressor 1 circuit 2
11. modulating output 0÷10V auxiliary heating
12. proportional output 4÷20mA condensation control circuit 1
13. proportional output 4÷20mA condensation control circuit 2
14. proportional output 4÷20mA damper / mixing valve free cooling direct action
15. proportional output 4÷20mA damper / mixing valve free cooling inverse action
16. auxiliary output 1 4÷20mA
17. auxiliary output 2 4÷20mA
18. auxiliary output 3 4÷20mA
19. auxiliary output 4 4÷20mA
20. modulating output 4÷20mA compressor 1 circuit 1
21. modulating output 4÷20mA compressor 1 circuit 2
22. modulating output 4÷20mA auxiliary heating

External relay driving ON/OFF output (o1-c91, see relevant configurations)

10.5 ANALOGUE INPUTS CALIBRATION

In case of analogue input value is not very precise, you can use parameters in group CA to set a offset to probe value to make the measurement more close to the actual value.

AI value used for controlling = AI measured value + calibration

- CA01 – CA06: On board probes calibration (1 - 6)
- CA11 – CA14: 1st XEV20D probes calibration (1 - 4)
- CA15 – CA18: 2nd XEV20D probes calibration (1 - 4)
- CA27 – CA33: 1st expansion probes calibration (1 - 7)

10.6 ANALOGUE INPUTS RANGE

When an AI is configured as a pressure probe (4÷20 mA / 0÷ 5 Volt), the value is restrained to range set by parameters in group RA.

- RA01 – RA06: On board probes range (1 - 6)
- RA21 – RA24: 1st XEV20D probes range (3 - 4)
- RA25 – RA28: 2nd XEV20D probes range (3 - 4)
- RA37 – RA50: 1st expansion probes range (1 - 7)

The probe type is determined by parameter SP01.

If SP01=0/1, the probe is current type (4÷20 mA).

If SP01=2/3, the probe is voltage type (0÷ 5 Volt).

For example, suppose:

IO01 = 52 - Circuit n° 1 condensing pressure probe (4÷20 mA / 0÷ 5 Volt)

RA01 = 1.0 Bar

RA02 = 10.0 Bar

SP01 = 2

So probe 1 measured pressure will be:

If AI01 = 0V, probe 1 pressure = 1.0 Bar (RA01)

If AI01 = 5V, probe 1 pressure = 10.0 Bar (RA02)

If AI01 = 2.5V, probe 1 pressure = 6.0 Bar ($RA01 + (RA02 - RA01) / 2$)

See graph below:

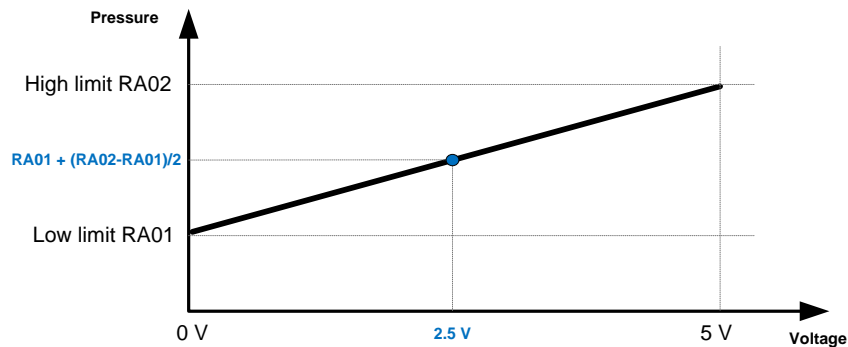

10.7 FURTHER CONNECTIONS

- 1 USB
- 1 Network
- 1 connector for/GSM modem /XWEB modem
- 1 RS485 master
- 1 RS485 slave
- 1 CANbus

11. ALARMS

The alarm codes and signals are made up from letters and numbers that identify the different types.
Types of alarm:

- Letter **A** = unit alarm
- Letter **B** = circuit alarm
- Letter **C** = compressor alarm

11.1 PROBE BREAKDOWN

Alarm code	AP1 ...AP46 (probe1 alarm -... probe46 alarm)
Display in keyboard	Pb AL1 ... Pb AL6 (probe1-...probe6 alarm) Pb1 AL e1 ...Pb7 AL e1 (Expansion1 probe1...probe7 alarm) Pb1 AL V1... Pb4 AL V1 (XEV20D 1 probe1... XEV20D 1 probe4) Pb1 AL V2... Pb4 AL V2 (XEV20D 2 probe1... XEV20D 2 probe4)
Cause of activation	Probe is configured and converted value out of range
Reset	Probe is not configured or converted value within range
Reset	Automatic
Icon	 flashing
Action	Alarm relay + buzzer activated
Regulators	
Alarm	Relay + buzzer activated
Reverse valve	It follows its regulation
Recovery valve	It follows its regulation
Free-cooling on/off valve	It follows its regulation
Auxiliary relay	It follows its regulation
0-10V auxiliary outputs	It follows its regulation
Idle running valve	It follows its regulation
Supply ventilation	It follows its regulation
Condensation ventilation	*Off
Support	*Off
boiler/anti-freeze	*With Ar09 = 1 on if at least 1 probe is configured for control
Pump/and water evaporator and condenser	*It follows/they follow its/their regulation
Compressors	*Off
Pump down solenoid valve	*Off

WARNING:

Symbol "*" means that the component is only forced to switch-off when the broken probe is a regulation probe. If the alarm comes from a display probe, the unit continues to follow normal regulation.

11.2 HIGH PRESSURE PRESSURE SWITCH ALARM

Alarm code	b1HP-...b2HP (circuit n° 1...2 high pressure pressure switch alarm)
Display in keyboard	Hi press circ1-... Hi press circ2
Cause of activation	With unit in ON and circuit high pressure pressure switch input active Circuit1: DI High pressure pressure switch circuit 1 (DI type=8) active Circuit2: DI High pressure pressure switch circuit 2 (DI type=9) active
Reset	Input not activated

Reset	Reset is always manual if AL11 = 0 Reset is always automatic if AL11 = 60 Reset passes from automatic to manual if AL11 goes from 1 to 59 (reset procedure in functions menu)
Icon	 flashing
Action	Alarm relay (DO type=66...67) + buzzer activated
Regulators	
Alarm	Relay + buzzer activated
Reverse valve	it follows its regulation
Recovery valve	it follows its regulation
Free-cooling on/off valve	it follows its regulation
Auxiliary relay	It follows/they follow its/their regulation
0÷10V proportional output	It follows/they follow its/their regulation
Idle running valve	It follows its regulation
Supply ventilation	It follows its regulation
Condensation ventilation	If the Par. FA02= 0, fan working mode dependent on the compressor. With alarm active the fans are forced to maximum speed for 60 seconds before switching-off If the Par. FA02= 1, fan working mode independent from the compressor. With alarm active the fans are forced to maximum speed for 60 seconds and then follow their regulation
Support/boiler/anti-freeze	It follows its regulation
Pump/and water evaporator and condenser	It follows its regulation
Affected circuits compressors	Off
Unaffected circuits compressors	They follow its regulation
Unaffected circuits pump down solenoid valves	They follow its regulation
Affected circuits pump down solenoid valves	Off

11.3 COMPRESSOR HIGH DISCHARGE THERMOSTAT ALARM FROM DIGITAL INPUT

Alarm code	C1dt...C6dt (compressor 1...6 high discharge thermostat alarm)
Display in keyboard	Hi temp C1...Hi temp C6
Cause of activation	With unit in ON and compressor discharge thermostat digital input active. From DI: Compressor 1...6 discharge thermostat (DI type=12...17)
Reset	Input deactivation
Reset	Reset is always manual if AL11 = 0 Reset is always automatic if AL11 =60 Reset passes from automatic to manual if AL11 goes from 1 to 59 (reset procedure in functions menu)
Icon	 flashing
Action	Alarm relay + buzzer activated
Regulators	
Alarm	Relay + buzzer activated
Reverse valve	it follows its regulation
Recovery valve	it follows its regulation
Free-cooling on/off valve	it follows its regulation
Auxiliary relay	It follows/they follow its/their regulation
0÷10V proportional output	It follows/they follow its/their regulation

Idle running valve	It follows its regulation
Supply ventilation	It follows its regulation
Condensation ventilation	It follows its regulation
Support/boiler/anti-freeze	It follows its regulation
Pump/and water evaporator and condenser	It follows its regulation
Compressor affected	Off
Compressor not affected	It follows its regulation
Pump down solenoid valve	It switches-off if there is only 1 compressor per circuit, otherwise it follows its regulation

11.4 LOW PRESSURE PRESSURE SWITCH ALARM

AL 1	Low pressure alarm delay from a digital/analogue input	0	250	Sec	
AL 2	Defines low pressure alarm operation with pump-down enabled 0 = independent from the pump down 1 = blocks the compressors until the pressure switch is disabled 2 = lets the compressors reach peak values	0	2		
AL 5	Maximum number of interventions per hour of the low pressure alarm from a digital/analogue input. If the number exceeds AL05 the alarm becomes manual reset. Reset is always manual if AL05 = 0 Reset is always automatic if AL05 = 60 Reset moves from automatic to manual if AL05 moves from 1 to 59	0	60		
AL 6	Low temperature / pressure alarm in defrost mode 0 = not enabled 1 = enabled	0	1		
AL 7	Low temperature / pressure alarm delay in defrost mode Delay time between alarm condition occurrence and reaction by device	0	250	Sec	
AL 8	Low temperature/pressure alarm with the unit in remote OFF or Stand-by mode 0 = alarm detection disabled 1 = alarm detection enabled	0	1		

Alarm code	b1LP-...b2LP (circuit n° 1...2 low pressure pressure switch alarm)
Display in keyboard	Low press circ1-... Low press circ2
Cause of activation	<ul style="list-style-type: none"> With circuit low pressure pressure switch active. From DI Low pressure pressure switch circuit 1...2 (DI type=10...11) If AL08=1, also with unit in stand-by or OFF remote, if circuit low pressure pressure switch input active In defrost if AL06=1 if compressor low pressure pressure switch input active <p>The alarm is not signalled:</p> <ol style="list-style-type: none"> in defrost for time AL07 in correspondence with activation of the reverse valve cycle On compressor switch-on for the time AL01 AL02 = 0 the low pressure alarm is inhibited during compressor stopping in pump down mode and with compressor at a standstill AL02 ≠ 0 the low pressure alarm is inhibited during compressor stopping in pump down mode and with compressor at a standstill for the time set
Reset	Input deactivation
Reset	Automatic – it becomes manual after AL05 interventions/hour (reset procedure in functions menu)
Icon	 flashing
Action	Alarm relay(DO type=68...69) + buzzer activated
Regulators	
Alarm	Relay + buzzer activated
Reverse valve	it follows its regulation

Recovery valve	it follows its regulation
Free-cooling on/off valve	it follows its regulation
Auxiliary relay	It follows/they follow its/their regulation
0÷10V proportional output	It follows/they follow its/their regulation
Idle running valve	It follows its regulation
Supply ventilation	It follows its regulation
Condensation ventilation	Off
Support/boiler/anti-freeze	It follows its regulation
Pump/and water evaporator and condenser	It follows its regulation
Compressors	Off
Pump down solenoid valve	off

11.5 OIL FLOAT/PRESSURE SWITCH ALARM

Alarm code	OPC1-...OPC6 (compressor n°1...6 oil pressure switch alarm)
Display in keyboard	AL oil C1-...AL oil C6
Cause of activation	DI configured as Compressor x oil pressure switch / float (DI type=36...41) activated. The alarm is not signalled: on compressor switch-on for the time AL12. After time AL12 it is not signalled with unit in normal working conditions for time AL13. If AL15 = 0 the alarm is not detected with the compressor off
Reset	Input deactivation
Reset	Automatic – it becomes manual after AL14 interventions/hour (reset procedure in functions menu)
Icon	 flashing
Action	Alarm relay + buzzer activated
Regulators	
Alarm	Relay + buzzer activated
Reverse valve	it follows its regulation
Recovery valve	it follows its regulation
Free-cooling on/off valve	it follows its regulation
Auxiliary relay	It follows/they follow its/their regulation
0÷10V proportional output	It follows/they follow its/their regulation
Idle running valve	It follows its regulation
Flow ventilation	It follows its regulation
Condensation ventilation	It follows its regulation
Support/boiler/anti-freeze	It follows its regulation
Pump/water evaporator and condenser	It follows its regulation
Compressors affected	Off
Compressor not affected	It follows its regulation
Pump down solenoid valve	It switches-off if there is only 1 compressor per circuit, otherwise it follows its regulation

OIL ALARM WORKING DUE TO PRESSURE SWITCH OR FLOAT (SCREW)

It is possible that both safety systems can exist together in certain applications. The delay, the active input duration and the number of interventions per hour are used to correctly manage the two safety devices.

Par. **AL12**

Oil alarm delay due to compressor activation.

Allows to set a delay in recognising the alarm of the pressure switch and the float from compressor start-up.

Par. **AL13**

Float pressure switch input active duration in normal working conditions.

Allows to set a time during which the oil alarm must remain active in normal working conditions. The alarm is signalled after this time. The count starts after the **AL13** time. It allows to filter any pressure or oil level drops that may occur for brief moments, e.g. with the activation of a compressor unloader step.

Par. **AL14**

Maximum number of oil alarm interventions per hour.

It determines a maximum number of oil alarm interventions per hour. When these are exceeded the alarm passes from automatic to manual reset.

Par. **AL15**

Oil float/pressure switch alarm with compressor in OFF if a differential oil pressure switch is used.

0 = alarm detection not enabled

1= alarm detection enabled

11.6 CONDENSATION HIGH TEMPERATURE/ PRESSURE ALARM

Alarm code	b1hp...b2hp (circuit n° 1...2 condensation high temperature/pressure alarm)
Display in keyboard	Hi t/p.cond.circ1...Hi t/p.cond.circ2
Cause of activation	With unit working in chiller or heat pump mode, if the condensation control probe value \geq AL09 set. The condensation control probes' AI type can be 28...31, depending on SP01.
Reset	If the condensation control probe value \leq AL09 set – AL10 differential
Reset	Reset is always manual if AL11 = 0 Reset is always automatic if AL11 =60 Reset passes from automatic to manual if AL11 goes from 1 to 59 (reset procedure in functions menu)
Icon	 flashing
Action	Alarm relay + buzzer activated
Regulators	
Alarm	Relay + buzzer activated
Reverse valve	it follows its regulation
Recovery valve	it follows its regulation
Free-cooling on/off valve	it follows its regulation
Auxiliary relay	It follows/they follow its/their regulation
Idle running valve	It follows its regulation
Supply ventilation	It follows its regulation
Condensation ventilation	If the Par. FA02= 0 fan working mode dependent on the compressor. With alarm active the fans are forced to maximum speed for 60 seconds before switching-off If the Par. FA02= 1 fan working mode independent from the compressor. With alarm active the fans are forced to maximum speed for 60 seconds and then follow their regulation
Support/boiler/anti-freeze	It follows its regulation
Pump/and water evaporator and condenser	It follows its regulation
Affected circuits compressors	Off
Unaffected circuits compressors	It follows its regulation
Unaffected circuits pump down solenoid valve	It follows its regulation
Affected circuits pump down solenoid valve	off

11.7 LOW CONDENSATION TEMPERATURE/PRESSURE ALARM (IF THE EVAPORATOR PRESSURE PROBES ARE NOT CONFIGURED)

Alarm code	b1lp-...b2lp (circuit n° 1-...circuit n° 2 condensation low temp/pressure alarm)
Display in keyboard	Low press circuit1-...Low press circuit2
Cause of activation	<p>The alarm is activated when the probe configures as condensation control probes (AI type=28...31) < AL03 set in the following conditions. And evaporator pressure probes (AI type=32...33) are not configured.</p> <ul style="list-style-type: none"> • working in cooling or heating mode • stand-by or OFF-remote if AL08 = 1 <ul style="list-style-type: none"> ▪ In defrost if AL06=1 <p>The alarm is not signalled:</p> <ul style="list-style-type: none"> • in defrost for time AL07 in correspondence with valve inversion • on compressor switch-on for the time AL01
Reset	If the condensation control probe's temperature/pressure > AL03 + differential AL04
Reset	Automatic – it becomes manual after AL05 interventions/hour (reset procedure in functions menu)
Icon	 flashing
Action	Alarm relay + buzzer activated
Regulators	
Alarm	Relay + buzzer activated
Reverse valve	it follows its regulation
Recovery valve	it follows its regulation
Free-cooling on/off valve	it follows its regulation
Auxiliary relay	It follows/they follow its/their regulation
Idle running valve	It follows its regulation
Supply ventilation	It follows its regulation
Condensation ventilation	Off
Support/boiler/anti-freeze	It follows its regulation
Pump/and water evaporator and condenser	It follows its regulation
Compressors	Off
Pump down solenoid valve	off

11.8 LOW EVAPORATION PRESSURE ALARM (IF THE EVAPORATOR PRESSURE PROBES ARE CONFIGURED)

Alarm code	b1Ip-...b2IP (circuit n° 1-...circuit n°2 evaporator low pressure alarm)
Display in keyboard	Low press circuit1-...Low press circuit2
Cause of activation	<p>The alarm is activated when the probe configures as the evaporator pressure (AI type=32...33) < AL03 set in the following conditions.</p> <ul style="list-style-type: none"> • working in cooling or heating mode • stand-by or OFF-remote if AL08 = 1 <ul style="list-style-type: none"> ▪ In defrost if AL06=1 <p>The alarm is not signalled:</p> <ul style="list-style-type: none"> • in defrost for time AL07 in correspondence with valve inversion • on compressor switch-on for the time AL01
Reset	If the evaporation control probe measures a temperature > of the AL03 set + differential AL04
Reset	Automatic – it becomes manual after AL05 interventions/hour (reset procedure in functions menu)
Icon	 flashing
Action	Relay + buzzer activated
Regulators	
Alarm	Relay + buzzer activated
Reverse valve	it follows its regulation
Recovery valve	it follows its regulation
Free-cooling on/off valve	it follows its regulation
Auxiliary relay	It follows/they follow its/their regulation
Idle running valve	It follows its regulation
Supply ventilation	It follows its regulation
Condensation ventilation	Off
Support/boiler/anti-freeze	It follows its regulation
Pump/and water evaporator and condenser	It follows its regulation
Affected compressors	Off
Unaffected compressors	It follows its regulation
Unaffected circuits pump down solenoid valve	It follows its regulation
Affected circuits pump down solenoid valve	off

11.9 AIR/AIR UNIT LOW TEMPERATURE ALARM & ANTI-FREEZE ALARM IN CHILLER MODE

Alarm code	b1AC-...b2AC (Low temperature/anti-freeze alarm in circuit n°1..2 chiller mode)
Display in keyboard	From DI: Antif/lo temp.C1 (DI - CH)-...Antif/lo temp.C2 (DI - CH) From AI: Antif/lo temp.C1 (AI - CH)-...Antif/lo temp.C2 (AI - CH)
Cause of activation	In air/air unit, the low temperature alarm is detected. In other types of unit, antifreeze alarm is detected. It is detected both in chiller working mode and stand-by/OFF-remote mode. And the circuit must be configured with compressors. From DI: Antifreeze alarm circuit 1...2 (DI type=6...7). If only one DI configured, it will be used for all the 2 circuits. From AI: Select probes between evaporator probes(AI type=7...10) by par AL47 and check: <ul style="list-style-type: none"> • If the unit is working in chiller mode, when the selected probes value \leq AL34 set for AL36 time, alarm occur. • If the unit is in stand-by/OFF-remote mode, chose the highest value between AL34 and AL41 as SET, when the selected probes value \leq SET set for AL36/AL44 time, alarm occur.
Reset	From DI: DI deactive From AI: <ul style="list-style-type: none"> • Unit ON: Regulation probe for Pbr anti-freeze temperature \geq AL34 set + AL35 differential. • Unit OFF: Regulation probe for Pbr anti-freeze temperature \geq (AL34/AL41) set + (AL35/AL42) differential.
Reset	Automatic – becomes manual after certain number of interventions/hour (reset procedure in functions menu) This number can be: <ul style="list-style-type: none"> • Chiller: AL37 • Unit OFF: the minimum between AL37 and AL45
Icon	 flashing
Action	If AL38 = 0 only the compressors are switched off. The label alarm is signalled by the alarm relay, buzzer and the heaters are not activated If AL38 = 1 the compressors are switched off. The label alarm is signalled and the alarm relay + buzzer are activated. If the anti-freeze alarm comes from DI the anti-freeze heaters are also activated. Alarm relay DO type=82...83
Regulators	
Alarm	If AL38 = 1 Relay + buzzer activated + anti-freeze heaters
Reverse valve	it follows its regulation
Recovery valve	it follows its regulation
Free-cooling on/off valve	it follows its regulation
Auxiliary relay	It follows/they follow its/their regulation
Idle running valve	It follows its regulation
Supply ventilation	If air/air unit off
Condensation ventilation	It follows its regulation
Support/boiler/anti-freeze	If air/air unit off otherwise follows its regulation
Support/boiler/anti-freeze	With DI alarm activated
Pump/and water evaporator and condenser	They follow their regulation
Compressors	Off
Pump down solenoid valve	Off

11.10 AIR/AIR UNIT LOW TEMPERATURE ALARM & ANTI-FREEZE ALARM IN HEAT PUMP MODE

Alarm code	b1AH-...b2AH (anti-freeze alarm in circuit n° 1..2 heat pump mode)
Display in keyboard	From DI: Antif/lo temp.C1 (DI - HP)-...Antif/lo temp.C2 (DI - HP) From AI: Antif/lo temp.C1 (AI - HP)-...Antif/lo temp.C2 (AI - HP)
Cause of activation	In air/air unit, the low temperature alarm is detected. In other types of unit, antifreeze alarm is detected. It is detected both in heat pump working mode and stand-by/OFF-remote mode. And the circuit must be configured with compressors. When unit just switch on, this alarm is detected only after AL43 delay past. From DI: Antifreeze alarm circuit 1...2 (DI type=6...7). If only one DI configured, it will be used for all the 2 circuits. From AI: Select probes between evaporator probes(AI type=7...10) by par AL48 and check: <ul style="list-style-type: none"> • If the unit is working in heat pump mode, when the selected probes value \leq AL41 set for AL44 time, alarm occur. • If the unit is in stand-by/OFF-remote mode, chose the highest value between AL34 and AL41 as SET, when the selected probes value \leq SET set for AL36/AL44 time, alarm occur.
Reset	From DI: DI deactive From AI: <ul style="list-style-type: none"> • Unit ON: Regulation probe for anti-freeze temperature \geq A41 set + AL42 differential. • Unit OFF: Regulation probe for anti-freeze temperature \geq (AL34/AL41) set + (AL35/AL42) differential.
Reset	Automatic – becomes manual after certain number of interventions/hour (reset procedure in functions menu) This number can be: <ul style="list-style-type: none"> • Heat pump: AL45 • Unit OFF: the minimum between AL37 and AL45
Icon	 flashing
Action	If AL46=0 only the compressors are switched off. The label alarm is signalled by the alarm relay, buzzer and the heaters are not activated If AL46=1 the compressors are switched off. The label alarm is signalled and the alarm relay + buzzer are activated. If the anti-freeze alarm comes from DI the anti-freeze heaters are also activated
Regulators	
Alarm	If AL46 = 1 Relay + buzzer activated + anti-freeze heaters
Reverse valve	it follows its regulation
Recovery valve	it follows its regulation
Free-cooling on/off valve	it follows its regulation
Auxiliary relay	It follows/they follow its/their regulation
Idle running valve	It follows its regulation
Supply ventilation	If air/air unit off
Condensation ventilation	It follows its regulation
Support/boiler/anti-freeze	If air/air unit off otherwise follows its regulation
Support/boiler/anti-freeze	With DI alarm activated
Pump/and water evaporator and condenser	It follows its regulation
Compressors	Off
Pump down solenoid valve	off

WARNING

Par. AL43 anti-freeze alarm delay (air/air unit low outlet air temperature) on unit start-up in heating working mode.

If in stand-by/OFF remote working, the unit has an anti-freeze alarm and the time set in the Par. AL43 is different to zero; by selecting working in heating mode from the key or digital input the anti-freeze situation is reset and the compressors can be switched-on for the time set in the Par. AL35 as the unit heats the water or the air. On expiry of the AL43 delay time, if the Pbr anti-freeze regulation probe still measures a temperature \leq AL41 set for at least AL44 seconds, the unit is blocked and an anti-freeze alarm is generated.

11.11 AIR/AIR UNIT LOW TEMPERATURE ALARM & ANTI-FREEZE ALARM

Alarm code	b1A...b2A (Low temperature/anti-freeze alarm in circuit n° 1..2)
Display in keyboard	Antif/lo temp.C1 (AI)-...Antif/lo temp.C2 (AI)
Cause of activation	<p>In air/air unit, the low temperature alarm is detected. In other types of unit, antifreeze alarm is detected.</p> <p>It is detected both in heat pump working mode and stand-by/OFF-remote mode. And the circuit must be configured with compressors.</p> <p>(For heat pump mode, when unit just switch on, this alarm is detected only after AL43 delay past.)</p> <p>Select probes between condenser probes(AI type=11...16) by par AL49 and check:</p> <ul style="list-style-type: none"> • If the unit is working in chiller mode, when the selected probes value \leq AL34 set for AL36 time, alarm occur. • If the unit is working in heat pump mode, when the selected probes value \leq AL41 set for AL44 time, alarm occur. • If the unit is in stand-by/OFF-remote mode, chose the highest value between AL34 and AL41 as SET, when the selected probes value \leq SET set for AL36/AL44 time, alarm occur.
Reset	<ul style="list-style-type: none"> • Unit ON in chiller mode: Regulation probe for Pbr anti-freeze temperature \geq AL34 set + AL35 differential. • Unit ON in heat pump mode: Regulation probe for anti-freeze temperature \geq A41 set + AL42 differential. • Unit OFF: Regulation probe for anti-freeze temperature \geq (AL34/AL41) set + (AL35/AL42) differential.
Reset	<p>Automatic – becomes manual after certain number of interventions/hour (reset procedure in functions menu)</p> <p>This number can be:</p> <ul style="list-style-type: none"> • Chiller: AL37 • Heat pump: AL45 • Unit OFF: the minimum between AL37 and AL45
Icon	 flashing
Action	<p>If AL38 = 0 only the compressors are switched off. The label alarm is signalled by the alarm relay, buzzer and the heaters are not activated</p> <p>If AL38 = 1 the compressors are switched off. The label alarm is signalled and the alarm relay + buzzer are activated. If the anti-freeze alarm comes from DI the anti-freeze heaters are also activated</p>
Regulators	
Alarm	If AL38 = 1 Relay + buzzer activated + anti-freeze heaters
Reverse valve	it follows its regulation
Recovery valve	it follows its regulation
Free-cooling on/off valve	it follows its regulation
Auxiliary relay	It follows/they follow its/their regulation
Idle running valve	It follows its regulation
Supply ventilation	If air/air unit off
Condensation ventilation	It follows its regulation

Support/boiler/anti-freeze	If air/air unit off otherwise follows its regulation
Support/boiler/anti-freeze	With DI alarm activated
Pump/and water evaporator and condenser	They follow their regulation
Compressors	Off
Pump down solenoid valve	Off

11.12 EVAPORATOR SIDE FLOW SWITCH ALARM (DIFFERENTIAL PRESSURE SWITCH)

Alarm code	AEFL (Evaporator side flow switch alarm)
Display in keyboard	Plant side flow AL
Cause of activation	Detect DI configured as Evaporator flow switch (DI type=3). If pumps are not managed (PA01=0), when DI active, alarm occur. If pumps are managed and polarity check not required (AL20=1), after a delay of AL16 from pump start-up, if DI keeps active for AL18, alarm occur. If pumps are managed and polarity check required (AL20≠1), after a delay of AL16 from pump start-up, if DI still keeps the same status as that when pump not working for AL18, alarm occur.
Reset	DI not active. If pumps are managed, wait for time AL19 after DI deactive.
Reset	Automatic – it becomes manual if this alarm active for time AL17 (reset procedure in functions menu)
Icon	 flashing
Action	Alarm (DO type=70) + buzzer relays only activated if the flow switch alarm is activated in normal working phase
Regulators	
Alarm	Relay + buzzer only activated if the flow switch alarm is activated in normal working phase
Reverse valve	It follows its regulation
Recovery valve	It follows its regulation
Free-cooling on/off valve	It follows its regulation
Anti-freeze/Support/boiler	Off
Auxiliary relay	It follows its regulation
Supply ventilation	Off
Condensation ventilation	It follows its regulation
Evaporator water pump	With PA1=1 always on; off when the alarm becomes manual reset
Evaporator water pump	With PA1=2 follows its regulation; off when the alarm becomes manual reset
Condenser water pump	It follows its regulation
Compressors	Off
Pump down solenoid valve	Off

Flow Switch Alarm

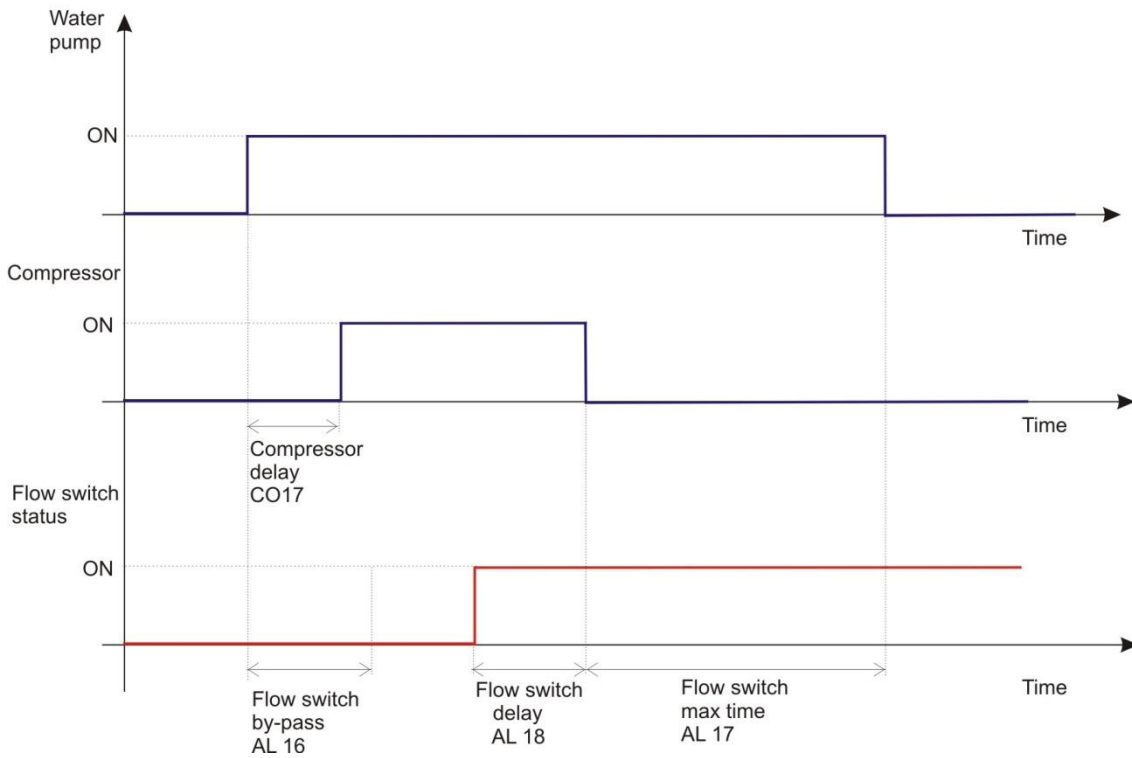

Air in the pipe (no flow switch alarm)

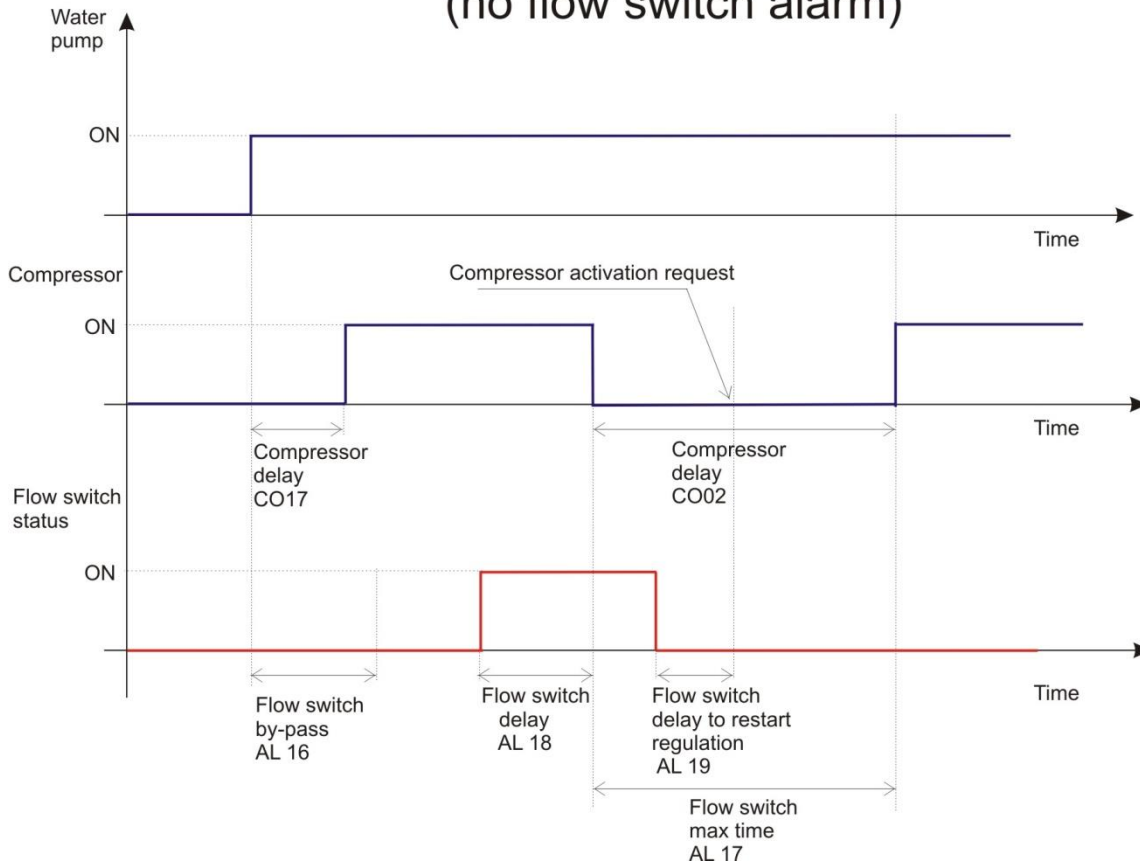

11.13 HOT SIDE FLOW SWITCH ALARM (DIFFERENTIAL PRESSURE SWITCH)

Alarm code	ACFL (Condenser side flow switch alarm)
Display in keyboard	Source side flow AL
Cause of activation	<p>Not in air/air unit (CF01 ≠ 0). Detect DI configured as Condenser flow switch (DI type=4):</p> <p>If pumps are not managed (PA17=0), when DI active, alarm occur.</p> <p>If pumps are managed and polarity check not required (AL26=1), after a delay of AL22 from pump start-up, if DI keeps active for AL24, alarm occur.</p> <p>If pumps are managed and polarity check required (AL26≠1), after a delay of AL22 from pump start-up, if DI still keeps the same status as that when pump not working for AL24, alarm occur.</p> <p>Note:</p> <p>When pumps are managed, check AL21 to determine if alarm detection is available in chiller mode or heat pump mode.</p> <p>Alarm only enabled in chiller mode if AL21=1</p> <p>Alarm only enabled in heat pump mode if AL21=2</p> <p>Alarm enabled in chiller and heat pump mode if AL21=3</p>
Reset	DI not active. If pumps are managed, wait for time AL25 after DI deactive.
Reset	Automatic – it becomes manual if this alarm active for time AL23 (reset procedure in functions menu)
Icon	 flashing
Action	Relay(DO type=71) + buzzer only activated if the flow switch alarm is activated in normal working phase
Regulators	
Alarm	Relay + buzzer only activated if the flow switch alarm is activated in normal working phase
Reverse valve	It follows its regulation
Recovery valve	It follows its regulation
Free-cooling on/off valve	It follows its regulation
Anti-freeze/Support/boiler	Off
Auxiliary relay	It follows its regulation
Supply ventilation	Off
Condensation ventilation	It follows its regulation
Condenser water pump	With PA17=1 always on; off when the alarm becomes manual reset
Condenser water pump	With PA17=2 follows its regulation; off when the alarm becomes manual reset
Evaporator water pump	It follows its regulation
Compressors	Off
Pump down solenoid valve	Off

WARNING

Relay + buzzer are only activated if the flow switch alarm is activated in normal working phase.

11.14 SUPPLY FAN OVERLOAD ALARM

Alarm code	AtSF (Supply fan overload alarm)
Display in keyboard	Overl supply fan
Cause of activation	If CF01 = 0 (air/air unit), with DI Thermal overload water pump 1 evaporator / thermal overload supply fan (DI type=27) active. On fan start-up, the alarm is ignored for time AL16
Reset	DI not active
Reset	Always manual
Icon	 flashing
Action	Alarm relay + buzzer activated
Regulators	
Alarm	Relay + buzzer activated
Reverse valve	it follows its regulation
Recovery valve	it follows its regulation
Free-cooling on/off valve	it follows its regulation
Auxiliary relay	it follows its regulation
Idle running valve	it follows its regulation
Supply ventilation	off
Condensation ventilation	off
Support/boiler/anti-freeze	off
Evaporator and condenser water pump	off
Compressors	off
Pump down solenoid valve	off

11.15 DOMESTIC HOT WATER PUMP FLOW SWITCH ALARM

Alarm code	AHFL (domestic hot water pump flow switch alarm)
Display in keyboard	Sanitary water flow AL
Cause of activation	(the flow switch alarm is only active with FS01 ≠ 0) Check DI configured as Sanitary water flow switch (DI type=5). If polarity check not required (AL20=1), after domestic hot water pump active for AL16 time, if DI active for AL18 time, alarm occur. If polarity check required (AL20≠1), after domestic hot water pump active for AL16 time, if DI still keeps the same status as that when domestic hot water pump is not working for AL18 time, alarm occur.
Reset	DI not active for the time AL19
Reset	Automatic – it becomes manual if this alarm active for time AL17 (reset procedure in functions menu)
Icon	 flashing
Action	Alarm (DO type=72) + buzzer relays only activated if the flow switch alarm is activated in normal working phase
Regulators	
Alarm	Relay + buzzer only activated if the flow switch alarm is activated in normal working phase
Domestic hot water pump	Off when the alarm becomes with manual reset
Production of domestic hot water function	Off
Other loads	They follow their regulation

11.16 SOLAR PANELS WATER PUMP FLOW SWITCH ALARM

Alarm code	APFL (solar panels pump flow switch alarm)
Display in keyboard	Solar panel flow AL
Cause of activation	(the flow switch alarm is only active with FS01 ≠ 0) Check DI configured as Solar panels flow switch (DI type=59). If polarity check not required (AL20=1), after solar panel pump active for AL16 time, if DI active for AL18 time, alarm occur. If polarity check required (AL20≠1), after domestic hot water pump active for AL16 time, if DI still keeps the same status as that when solar panel pump is not working for AL18 time, alarm occur.
Reset	DI not active for the time AL19
Reset	Automatic – it becomes manual if this alarm active for time AL17 (reset procedure in functions menu)
Icon	 flashing
Action	Alarm (DO type=73) + buzzer relays only activated if the flow switch alarm is activated in normal working phase
Regulators	
Alarm	Relay + buzzer only activated if the flow switch alarm is activated in normal working phase
Solar panels water pump	Off when the alarm becomes with manual reset
Solar coil on/off valve	Active
Other loads	They follow their regulation

11.17 COMPRESSOR OVERLOAD ALARM

Alarm code	C1tr (compressor n° 1 overload alarm) ... C6tr (compressor n° 6 overload alarm)
Display in keyboard	C1 overl...C6 overl
Cause of activation	The alarm is detected after AL27 delay from compressor switch-on. If AL30=1, the detection also enabled when compressor is off. With DI configured as Thermal overload compressor 1...6 (DI type=18...23) active, alarm occur.
Reset	If DI not active
Reset	Always manual. If more than AL28 compressor interventions occur per hour, password is request to do reset operation. The password is set in par AL31.
Icon	 flashing
Action	Alarm relay (DO type=76...81) + buzzer activated
Regulators	
Alarm	Relay + buzzer activated
Reverse valve	it follows its regulation
Recovery valve	it follows its regulation
Free-cooling on/off valve	it follows its regulation
Auxiliary relay	It follows its regulation
Idle running valve	It follows its regulation
Supply ventilation	It follows its regulation
Condensation ventilation	It follows its regulation
Support/boiler/anti-freeze	It follows/they follow its/their regulation
Pump/and water evaporator and condenser	It follows its regulation
Compressor affected	Always off

Compressors not affected	If Par. AL29 = 0 following their regulation If Par. AL29 = 1 off
Pump down solenoid valve	It switches-off if there is only 1 compressor per circuit, otherwise it follows its regulation

11.18 COMPRESSOR HIGH DISCHARGE TEMPERATURE ALARM FROM ANALOGUE INPUT

Alarm code	C1dt...C6dt (compressor n° 1...6 high discharge temperature alarm)
Display in keyboard	Hi Disch temp.C1...Hi Disch temp.C6
Cause of activation	The temperature measured by the probe configured as Compressor 1...6 PTC supply temperature probe (AI type=1...6) \geq AL50 set
Reset	The temperature measured by the probe configured as Compressor 1...6 PTC supply temperature probe (AI type=1...6) \leq AL50 set – AL51 differential
Reset	Automatic - Manual. If more than AL52 interventions per hour occur. Enter the functions menu to reset the alarm
Icon	 flashing
Action	Alarm relay (DO type=1)+ buzzer activated
Regulators	
Alarm	Relay + buzzer activated
Reverse valve	it follows its regulation
Recovery valve	it follows its regulation
Free-cooling on/off valve	it follows its regulation
Auxiliary relay	It follows its regulation
Idle running valve	It follows its regulation
Supply ventilation	It follows its regulation
Condensation ventilation	It follows its regulation
Support/boiler/anti-freeze	It follows/they follow its/their regulation
Pump/and water evaporator and condenser	It follows its regulation
Compressor affected	Off
Compressor not affected	It follows its regulation
Pump down solenoid valve	It switches-off if there is only 1 compressor per circuit, otherwise it follows its regulation
Liquid injection solenoid valve	Off with compressor in OFF

11.19 EVAPORATOR WATER INLET HIGH TEMPERATURE ALARM

Alarm code	AEht (evaporator water inlet high temperature alarm)
Display in keyboard	Hi temp.evap.water inlet
Cause of activation	The alarm only detect when CF01>0 (not in air/air unit) and unit is working in chiller mode. After compressors start-up for AL61 time, detect the probe selected by AL64. If the temperature measured by this probe \geq AL62 set, alarm occur.
Reset	The temperature measured by the probe configured in AL64 $<$ AL62 set – AL63 differential
Reset	Automatic - Manual Reset is always manual if AL60 = 0 Reset is always automatic if AL60 = 60 Reset passes from automatic to manual if AL60 goes from 1 to 59
Icon	 flashing
Action	Alarm relay + buzzer activated

Regulators	
Alarm	Relay + buzzer activated
Compressors	Off
Other loads	It follows its regulation

WARNING:

The alarm only appears if the unit is running with compressor on after time **AL61**.
The alarm remains in stand-by, OFF remote or with compressor off due to temperature control only if it was present before and with MANUAL reset.

11.20 CONDENSATION FAN OVERLOAD ALARM

Alarm code	b1tF...b2tF (circuit n° 1...2 condensation fan overload alarm)
Display in keyboard	Cond.fan overl circ1...Cond.fan overl circ2
Cause of activation	b1tF: FA06=1, DI Condensation fan thermal overload circuit 1 (DI type=24) active. b2tF: FA06=1, DI Condensation fan thermal overload Circuit 2(DI type=25) active.
Reset	With DI not active
Reset	Manual
Icon	 flashing
Action	Alarm relay(DO type=1) + buzzer activated
Regulators	
Alarm	Relay + buzzer activated
Reverse valve	it follows its regulation
Recovery valve	it follows its regulation
Free-cooling on/off valve	it follows its regulation
Auxiliary relay	it follows its regulation
Idle running valve	It follows its regulation
Supply ventilation	Off
Condensation ventilation	Off
Support/boiler/anti-freeze	It follows its regulation
Pump/and water evaporator and condenser	It follows its regulation
Compressors	Off
Pump down solenoid valve	Off

11.21 DEFROST ALARM

Alarm code	b1dF...b2dF (circuit n° 1...2 defrost alarm)
Display in keyboard	dF AL circ1...dF AL circ2
Cause of activation	In defrost only, if dF01 = 1/3, defrost should end for temperature/pressure or external contact. But actually, the defrost ends for dF05 time expired.
Reset	<ul style="list-style-type: none"> ▪ If switch to chiller mode or stand-by/ON-OFF remote mode. ▪ At the next defrost cycle, the ending takes place due to temperature/pressure.
Reset	Automatic if at the next defrost cycle the ending takes place due to temperature/pressure. Manual if at the next defrost cycle the ending still takes place due dF05 time expired. (reset procedure in functions menu)
Icon	 flashing

Action	Alarm + buzzer relays NOT activated
Regulators	
Alarm	Relay + buzzer NOT activated
Reverse valve	It follows its regulation
Recovery valve	it follows its regulation
Free-cooling on/off valve	it follows its regulation
Auxiliary relay	It follows its regulation
Idle running valve	It follows its regulation
Supply ventilation	It follows its regulation
Condensation ventilation	It follows its regulation
Support/boiler/anti-freeze	It follows its regulation
Pump/and water evaporator and condenser	It follows its regulation
Compressors	It follows its regulation
Pump down solenoid valve	It follows its regulation

11.22 UNLOADING ALARM DUE TO HIGH CONDENSATION TEMPERATURE/PRESSURE IN COOLING WORKING MODE

(Not available)

Alarm code	b1Cu...b2Cu (circuit n° 1...2 unloading condenser high temperature/pressure alarm)
Display in keyboard	Unload high t/p circ1...Unload high t/p circ2
Cause of activation	When working, if the probe configured as condensation temperature or pressure control measures a value > Un11 set
Reset	<ul style="list-style-type: none"> ▪ of the condensation pressure or temperature measures a value < Un11–Un12 differential ▪ By unloading function inserted after the time set Par. Un15
Reset	Automatic
Icon	 flashing
Action	Alarm relay + buzzer NOT activated
Regulators	
Alarm	Relay + buzzer NOT activated
Reverse valve	It follows its regulation
Recovery valve	it follows its regulation
Free-cooling on/off valve	it follows its regulation
Auxiliary relay	It follows its regulation
Idle running valve	It follows its regulation
Supply ventilation	It follows its regulation
Condensation ventilation	It follows its regulation
Support/boiler/anti-freeze	It follows its regulation
Pump/and water evaporator and condenser	It follows its regulation
Compressors	It follows its regulation
Pump down solenoid valve	It follows its regulation

11.23 HEAT RECOVERY DISABLING SIGNAL DUE TO HIGH CONDENSATION TEMPERATURE/PRESSURE IN COOLING WORKING MODE

Alarm code	b1rC...b2rC (circuit n° 1...2 recovery disabling alarm)
Display in keyboard	Recovery dis.hi t/p C1...Recovery dis.hi t/p C2

Cause of activation	RC01=3, if the probe for disable heat recovery (configured as condensation temperature or pressure) measures a value \geq rC07 set, alarm occur.
Reset	<ul style="list-style-type: none"> ▪ The condensation pressure or temperature probe measures a value \leq rc07 set – rC08 differential ▪ Heat recovery disabling function is intervened due to Par. rC09 time expired.
Reset	Automatic
Icon	 flashing
Action	Alarm relay + buzzer NOT activated
Regulators	
Alarm	Relay + buzzer NOT activated
Reverse valve	It follows its regulation
Recovery valve	Off
Free-cooling on/off valve	it follows its regulation
Auxiliary relay	It follows its regulation
Idle running valve	It follows its regulation
Supply ventilation	It follows its regulation
Condensation ventilation	It follows its regulation
Support/boiler/anti-freeze	It follows its regulation
Pump/and water evaporator and condenser	It follows its regulation
Compressors	It follows its regulation
Pump down solenoid valve	It follows its regulation

11.24 UNLOADING SIGNAL DUE TO LOW EVAPORATION PRESSURE IN HEATING WORKING MODE

(Not available)

Display label meaning	b1Eu (circuit n° 1 unloading from condenser coil signal) b2Eu (circuit n° 2 unloading from condenser coil signal)
Display in keyboard	Unload lo press.circ1...Unload lo press.circ4
Cause of activation	When working, if the probe configured as condensation temperature, configured as pressure control or as evaporation pressure, measures a value $<$ Un13 set
Reset	<ul style="list-style-type: none"> ▪ if the condensation pressure/temperature or the evaporation pressure measures a value $>$ Un13 + Un14 ▪ With unloading function inserted after the time set Par. Un15
Reset	Automatic
Icon	 flashing
Action	Alarm relay + buzzer NOT activated
Regulators	
Alarm	Relay + buzzer NOT activated
Reverse valve	It follows its regulation
Recovery valve	it follows its regulation
Free-cooling on/off valve	it follows its regulation
Auxiliary relay	It follows its regulation
Idle running valve	It follows its regulation
Supply ventilation	It follows its regulation
Condensation ventilation	It follows its regulation
Support/boiler/anti-freeze	It follows its regulation
Pump/and water evaporator and condenser	It follows its regulation
Compressors	It follows its regulation
Pump down solenoid valve	It follows its regulation

11.25 UNLOADING SIGNAL DUE TO EVAPORATOR WATER INLET HIGH TEMPERATURE

(Not available)

Alarm code	AEun (unloading signal from evaporator)
Display in keyboard	Unload notify (evap.)
Cause of activation	In working mode if the evaporator water inlet temperature measured > Un1 set for the time set in the Par. Un3
Reset	<ul style="list-style-type: none"> ▪ if the water temperature measured < Un1 set – Un2 differential ▪ By unloading function inserted after the time set Par. Un4
Reset	Automatic
Icon	 flashing
Action	Alarm relay + buzzer NOT activated
Regulators	
Alarm	Relay + buzzer NOT activated
Reverse valve	It follows its regulation
Recovery valve	it follows its regulation
Free-cooling on/off valve	it follows its regulation
Auxiliary relay	It follows its regulation
Idle running valve	It follows its regulation
Supply ventilation	It follows its regulation
Condensation ventilation	It follows its regulation
Support/boiler/anti-freeze	It follows its regulation
Pump/and water evaporator and condenser	It follows its regulation
Compressors	It follows its regulation
Pump down solenoid valve	It follows its regulation

11.26 PUMP DOWN ALARM WITH LOW PRESSURE PRESSURE SWITCH/TRANSDUCER IN STOPPING

Alarm code	b1PH...b2PH (pump-down alarm in circuit n° 1...2 in stopping)
Display in keyboard	Pump down at stop circ1...Pump down at stop circ2
Cause of activation	<p>With Pd1 ≠ 0, pump-down when compressor stopping:</p> <ul style="list-style-type: none"> ▪ Pressure switch DI configured: with DI configured as Pump down pressure switch circuit 1...2 (DI type = 42-43) or Low pressure pressure switch circuit 1...2 (DI type = 10-11) not active and the pump-down ends by time Pd4. ▪ Transducer configured: the probe configured as Circuit 1...2 evaporation pressure probe (pressure 4÷20 mA / ratiometric 0÷ 5 Volt) (AI type = 32-33) measures the value >= set Pd02 + Pd03 differential and the pump-down ends by time Pd04.
Reset	The circuit has compressor running. User push RESET key from the keyboard.
Reset	Always manual reset
Icon	 flashing
Action	Alarm relay + buzzer activated only when the alarm becomes manual reset
Regulators	
Alarm	Relay + buzzer activated only when the alarm becomes manual reset
Reverse valve	It follows its regulation
Recovery valve	it follows its regulation
Free-cooling on/off valve	it follows its regulation
Auxiliary relay	It follows its regulation
Idle running valve	It follows its regulation
Supply ventilation	It follows its regulation

Condensation ventilation	It follows its regulation
Support/boiler/anti-freeze	It follows its regulation
Pump/and water evaporator and condenser	It follows its regulation
Compressors	Off with manual reset alarm
Pump down solenoid valve	It follows its regulation

11.27 PUMP DOWN ALARM WITH LOW PRESSURE TRANSDUCER IN START-UP

Alarm code	b1PL...b2PL (pump-down alarm in circuit n° 1...2 in start-up)
Display in keyboard	Pump down at start circ1...Pump down at start circ2
Cause of activation	With Pd1 ≠ 0 , pump-down when compressor start-up: <ul style="list-style-type: none"> ▪ Pressure switch DI configured: with DI configured as Pump down pressure switch circuit 1...2 (DI type = 42-43) or Low pressure pressure switch circuit 1...2 (DI type = 10-11) keeps active and the pump-down ends by time Pd4. ▪ Transducer configured: the probe configured as Circuit 1...2 evaporating pressure probe (pressure 4÷20 mA / ratiometric 0÷ 5 Volt) (AI type = 32-33) measures the value ≤ set Pd02 and the pump-down ends by time Pd04.
Reset	DI deactive or probe value > set Pd02
Reset	Automatic/becomes manual after Pd8 interventions per hour if Pd9 =1 (reset procedure in functions menu) If Pd9 = 0 it remains with automatic reset. It is recorded in the historical alarms only with manual reset
Icon	 flashing
Action	Alarm relay + buzzer activated only when the alarm becomes manual reset
Regulators	
Alarm	Relay + buzzer activated only when the alarm becomes manual reset
Reverse valve	It follows its regulation
Recovery valve	it follows its regulation
Free-cooling on/off valve	it follows its regulation
Auxiliary relay	It follows its regulation
Idle running valve	It follows its regulation
Supply ventilation	It follows its regulation
Condensation ventilation	It follows its regulation
Support/boiler/anti-freeze	It follows its regulation
Pump/and water evaporator and condenser	It follows its regulation
Compressors	Off with manual reset alarm
Pump down solenoid valve	It follows its regulation

11.28 EVAPORATOR WATER PUMP OVERLOAD ALARM

Alarm code	AtE1 (evaporator n° 1 water pump overload alarm) AtE2 (evaporator support n° 2 water pump overload alarm)
Display in keyboard	Evap.pump 1 overl Evap.pump 2 overl
Cause of activation	DI configured as Thermal overload water pump 1 evaporator / thermal overload supply fan (DI type=27) active and par CF01≠0. DI configured as Evaporator support water pump thermal overload (DI type=28) active.
Reset	With DI not active

Reset	Manual. (reset procedure in functions menu)
Icon	 flashing
Action	Alarm relay (DO type=1)+ buzzer activated
Regulators	
Alarm	Relay + buzzer activated
Reverse valve	It follows its regulation
Recovery valve	it follows its regulation
Free-cooling on/off valve	it follows its regulation
Auxiliary relay	it follows its regulation
Idle running valve	It follows its regulation
Supply ventilation	Off if no pump is available
Condensation ventilation	Off if no pump is available
Support/boiler/anti-freeze	It follows its regulation
Evaporator water pump	Off if pump is available
Condenser water pump	It follows its regulation
Compressors	Off if pump is available
Pump down solenoid valve	Off if pump is available

11.29 CONDENSER WATER PUMPING OVERLOAD ALARM

Alarm code	AtC1 (condenser n° 1 water pump overload alarm) AtC2 (condenser support n° 2 water pump overload alarm)
Display in keyboard	Cond.pump 1 over! Cond.pump 2 over!
Cause of activation	DI configured as Thermal overload water pump 1 condenser (AI type=29) active. DI configured as Condenser support water pump thermal overload (AI type=30) active.
Reset	With DI not active
Reset	Manual.
Icon	 flashing
Action	Alarm relay (DO type=1) + buzzer activated
Regulators	
Alarm	Relay + buzzer activated
Reverse valve	It follows its regulation
Recovery valve	it follows its regulation
Free-cooling on/off valve	it follows its regulation
Auxiliary relay	it follows its regulation
Idle running valve	It follows its regulation
Supply ventilation	Off if no pump is available
Condensation ventilation	Off if no pump is available
Support/boiler/anti-freeze	It follows its regulation
Evaporator water pump	It follows its regulation
Condenser water pump	Off if no pump is available
Compressors	Off if no pump is available
Pump down solenoid valve	Off if no pump is available

11.30 GENERIC ALARM 1

Alarm code	ALc1 (Generic alarm 1)
Display in keyboard	Generic AL1
Cause of activation	DI configured as Digital input general block alarm unit 1 (DI type=44) active for the time set in the Par AL54
Reset	DI configured as Digital input general block alarm unit 1 (DI type=44) not active for the time set in the Par AL55
Reset	Automatic – becomes manual after AL53 interventions/hour. It is recorded in the historical alarms only with manual reset
Icon	 flashing
Action	Alarm relay (DO type=74) + buzzer activated
Regulators	
Alarm	Relay + buzzer activated
Other loads	Off

11.31 GENERIC ALARM 2

Alarm code	ALc2 (Generic alarm 2)
Display in keyboard	Generic AL2
Cause of activation	DI configured as Digital input general alarm alert / block unit 2 (DI type=45) active for the time set in the Par AL58
Reset	DI configured as Digital input general alarm alert / block unit 2 (DI type=45) not active for the time set in the Par AL59
Reset	If AL56=0, always automatic. If AL56=1, automatic-manual. It becomes manual after AL57 interventions/hour.
Icon	 flashing
Action	Alarm relay (DO type=75) + buzzer activated
Regulators	
Alarm	Relay + buzzer activated
Other loads	Off

11.32 COMPRESSORS MAINTENANCE ALARM

Alarm code	C1Mn ...C6Mn (compressor n° 1...6 maintenance request)
Display in keyboard	C1 maint req. ...C6 maint req.
Cause of activation	Compressor is configured and its working hours > timer set by CO53
Reset	Reset working hours (from keyboard)
Reset	Automatic (after the hours reset)
Icon	 flashing
Action	Alarm relay + buzzer activated
Regulators	
Alarm	Relay(DO type=1) + buzzer activated
Other loads	They follow their regulation

11.33 EVAPORATOR FAN/ PUMPS MAINTENANCE ALARM

Alarm code	AEP1 (evaporator n° 1 water pump maintenance request) AEP2 (evaporator support n° 2 water pump maintenance request)
-------------------	--

Display in keyboard	Evap.pump 1 maint Evap.pump 2 maint
Cause of activation	Water/fan pump working hours >= timer set PA13 Water support pump working hours >= timer set PA14
Reset	Reset working hours (From keyboard)
Reset	Automatic (after the hours reset)
Icon	 flashing
Action	Alarm relay (DO type=1) + buzzer activated
Regulators	
Alarm	Relay + buzzer activated
Other loads	They follow their regulation

11.34 CONDENSER PUMPS MAINTENANCE ALARM

Alarm code	ACP1 (condenser n° 1 water pump maintenance request) ACP2 (condenser n° 2 water pump maintenance request)
Display in keyboard	Cond.pump 1 maint Cond.pump 2 maint
Cause of activation	Condenser water pump 1 working hours >= timer set PA29 Condenser water pump 2 working hours >= timer set PA30
Reset	Reset working hours (in functions menu)
Reset	Automatic (after the hours reset)
Icon	 flashing
Action	Alarm relay (DO type=1) + buzzer activated
Regulators	
Alarm	Relay + buzzer activated
Other loads	They follow their regulation

11.35 XEV20D NOT CONNECT ALARM

Alarm code	AET1 ...AET2 (XEV20D 1... XEV20D 2 not connect alarm)
Display in keyboard	V1 discon...V2 discon
Cause of activation	AET1: Et09+Et10>0, XEV20D 1 lose communication by can bus. AET2: Et11+Et12>0, XEV20D 2 lose communication by can bus.
Reset	Et09...Et12=0 or XEV20D communication is recovered.
Reset	Automatic
Icon	 flashing
Action	Alarm relay (DO type=1) + buzzer activated
Regulators	
Alarm	Relay + buzzer activated
Compressors	Off

11.36 EXPANSION MOUDLE NOT CONNECT ALARM

Alarm code	AEM1 (IPROEX60D 1 not connect alarm)
Display in keyboard	E1 discon
Cause of activation	The expansion IPROEX60D IO (AI/DI/AO/DO) is used and lose communication by can bus.
Reset	IPROEX60D IO is disabled or communication is recovered.
Reset	Automatic
Icon	 flashing

Action	Alarm relay (DO type=1) + buzzer activated
Regulators	
Alarm	Relay + buzzer activated
Other loads	Off

11.37 PHASES SEQUENCE ALARM

Alarm code	APS (Phases sequence alarm)
Display in keyboard	Phases sequ AL
Cause of activation	Digital input Incorrect sequence of phases (DI type=60) active.
Reset	Digital input Incorrect sequence of phases deactive.
Reset	Manual
Icon	 flashing
Action	Alarm relay (DO type=65) + buzzer activated
Regulators	
Alarm	Relay + buzzer activated
Other loads	Off

11.38 ANTI-FREEZE ALARM IN FREE-COOLING

Alarm code	AFFC (Anti-freeze alarm in free-cooling)
Display in keyboard	Antif AL FC
Cause of activation	FC01 = 4, During free-cooling working if External air / condenser water (free cooling)temperature NTC temperature probe (AI type=18) value \leq set FC07 for FC24 times. AFFC alarm will be signal after a delay of AL67.
Reset	External air temperature \geq set FC07 + differential FC08.
Reset	Automatic – becomes manual after AL68 interventions/hour.
Icon	 flashing
Action	Alarm relay (DO type=1) + buzzer activated
Regulators	
Alarm	Relay + buzzer activated
Other loads	Follow their regulation

11.39 BOILER OVERLOAD ALARM

Alarm code	Atrb (Boiler overload alarm)
Display in keyboard	Boiler overl AL
Cause of activation	Digital input Auxiliary heating thermal overload (DI type=61) active.
Reset	Digital input Thermal heaters deactive.
Reset	Automatic – becomes manual after AL70 interventions/hour.
Icon	 flashing
Action	Alarm relay (DO type=1) + buzzer activated
Regulators	
Alarm	Relay + buzzer activated
Auxiliary heaters	Off
Compressor	If AH01=1, compressor working should affected by auxiliary heating request. But when this Atrb alarm occur and AL69=1, compressor will not be affected.
Other loads	Follow their regulation

11.40 BOILER LOCK ALARM

Alarm code	ALcb (Boiler lock alarm)
Display in keyboard	Boiler lock AL
Cause of activation	Digital input Auxiliary heating block (DI type=62) active.
Reset	Digital input Block heaters deactive.
Reset	Automatic – becomes manual after AL71 interventions/hour.
Icon	 flashing
Action	Alarm relay (DO type=1) + buzzer activated
Regulators	
Alarm	Relay + buzzer activated
Auxiliary heaters	Off
Compressor	If AH01=1, compressor working should affected by auxiliary heating request. But when this Atrb alarm occur and AL69=1, compressor will not be affected.
Other loads	Follow their regulation

11.41 UNIT CONFIGURATION

Alarm code	ACF1
	<p>If defrost is enabled (dF01 ≠ 0)</p> <ul style="list-style-type: none"> • dF26=0 (0=Defrosting cycle start in unit independently) and dF27 ≠ 0 (0=Defrosting cycle end in unit independently). • dF26=2 (2 = if at least one has reached the request for defrosting to start) and dF27 ≠ 1 (1=if both have reached the defrost end status). • If more than one circuit is configured, FA06=0 and dF33=0 and dF26/dF27=0. <p>Set par AH16=1(1=Enable the auxiliary heater in defrost) and dF32=1 (1= Supply fan doesn't work during defrost).</p> <p>ACF2</p> <ul style="list-style-type: none"> • Unit configured as ON/OFF or proportional control of the condensation fan (FA01=2/3/4), but the relevant probes and circuits are not configured. (It should has: FA06=1(separate condensation), 1 probe per circuit. FA06=0 (unique condensation), at least 1 probe. • In case of fan with step regulation (FA01=2/3), any one of the following rules is not respected: FA10 < FA11 < FA25 < FA26. FA19 < FA20 < FA29 < FA30. FA35 < FA36 < FA41 < FA42. <p>In addition, make sure the step band <= step n set point – step n-1 set point. For example: FA12 <= FA11-FA10.</p> <ul style="list-style-type: none"> • In the case of proportional regulation (FA01=4) with chiller enabled (CF02 =1/3), at least one of the following rules is not respected: FA10 + FA12 + FA13 < FA11 FA13 < FA14 • In the case of proportional regulation (FA01=4) with heating enabled (CF02=2/3) at least one of the following rules is not respected: FA19 + FA22 + FA21 < FA20 FA22 < FA23 • In the case of proportional regulation (FA01=4) with heating enabled (CF02=2/3) and dF33=2 at least one of the following rules is not respected: FA35 + FA38 + FA37 < FA36 FA38 < FA39 • If heat pump is enabled (CF02=2/3) and defrost enabled (dF>0), but the relevant condensing/evaporating probes are not configured. <p>ACF3</p> <ul style="list-style-type: none"> • Two digital/analogue inputs configured with the same function. • If a compressor is configured, but relative compressor relays (Compressor 1...6 Direct start-up relay) are not configured. • If a compressor is not configured, but configured relative resources. Such as Discharge PTC probe and DI Compressor discharge thermostat and DI Compressor thermal overload and DI Oil pressure/level switch compressor. • If a circuit is not configured, but configured relative resources. For example, for circuit1, configured probes which AI types are 20, 28, 30 and 32. Configured DI which DI types are 6, 8, 10 and 42. • If FA06=0 (Unique condensation), configure redundant DI for fan overload (DI type=25/26). • If FA06=1 (Separate condensation), configure redundant DI for fan overload (DI type=26).

ACF4

- SP09 = 1 and DI Remote cooling/heating (DI type=2) not configured or SP09 = 2 and no NTC probe configured as external air temperature (AI type=19)
- CF04 ≠ 0, but no condensing unit digital input (DI type=48...58) configured.
- CF04 ≠ 0, besides DI Digital input temperature control request (moter-condensing unit) (DI type=48), also configured one DI as Chiller request digital input (DI type=49) or Heat pump request digital input (DI type=50).
- CF04 ≠ 0 and DI cooling/heating capacity request (DI type=51...58) configured incongruently with the configuration of the compressors/unloaders steps (see par CF05-CF10).

ACF5

For circuits n° 2, if a circuit is not configured, but relative resources have been configured (pump down relay, heaters, outdoor fans)

- If Pd01>0 and relays are configured as Pump down solenoid valve circuit 1...2 (DO type=18...19)
- Anti-freeze heaters enabled and relays are configured as Antifreeze heaters circuit 1...2 (DO type=4...5)
- FA01=4, FA06=1, and AO is configured as Proportional output 0÷10V/4÷20mA condensation control circuit 1/ 2 (AO type=1...2 or 12...13)
- FA01>0, FA06=1, and relays are configured as fan steps (DO type=10-17).

ACF6

- If SL01=0 and the total number of compressor power steps in the 2 circuits (set by CF05...CF10) is > 40.
- Compressor 3...6 is configured with more then 1 steps (CF09...CF10>0).

ACF7

If the pump down function is enabled (Pd01>0), but in at least one configured circuit:

- The relevant solenoid valve relay (DO type=18...19) is not configured.
- Pump down pressure switch (DI type=42...43) and circuit evaporating pressure transducer (AI type=32...33) are all not configured, and if the pump down is enabled also at start (Pd01=2/4) even the low pressure pressure switch (DI type=10...11) is configured

If at least one pump-down solenoid valve has been configured, but the pump-down solenoid valve does not correspond with the circuits configuration. For example, if circuit 2 is configured, but pump-down solenoid valve 2 does not exist.

ACF8

One or more compressors have been configured using parameters CF05 and CF08 but the relevant main relays are not configured:

For compressor 1 to 8:

- Intermittent valve relay (DO type=32...33) not configured when enabled by ON/OFF times (CO10 and CO11) $\neq 0$ or vice versa (relay configured but function is not enabled).
- No unloader (e.g. for comp. 1, DO type=47) and no gas by-pass (e.g. for comp.1, DO type=50) configured when by-pass time (CO15) is $\neq 0$ or vice versa (relay configured but function is not enabled).
- If CO12=0, compressor in direct start mode, but configured part-winding/star-delta start-up relays (e.g. for comp.1, DO type=45, 46).
- If CO12=1, compressor in part winding start mode, but relay for part winding start-up is not configured. (e.g. for comp.1, DO type=45). Or configured redundant relay as star-delta (e.g. for comp.1, DO type=46).
- If CO12=2, compressor in Star-delta start mode, but relevant relays are not configured (e.g. for comp.1, DO type=45, 46).
- No full match between relays configuration and unloaders defined on parameters CF09 – CF10.

For compressor 3 to 6:

No direct start-up relays configured (e.g. for comp.3, DO type=58).

For auxiliary heating, if it is disabled (AH01=0), but relevant resource are configured or vice versa (resource not configured but function is enabled). Such as DI for heater (DI type=61/62), relay Auxiliary heating 1...4 step (DO type=84...87), AO modulating auxiliary heating (AO type=11/22).

ACF9

evaporator pumps

- defined (PA01 $\neq 0$) but no relay (DO type=2 and 3) is configured
- not defined (PA01 = 0) but a relay is configured

condenser pump

- defined (PA17 $\neq 0$) but no relay (DO type=6 and 7) is configured
- not defined (PA17 = $\neq 0$) but a relay is configured

Pump rotation

- PA05 ≥ 3 , rotation at working hours, but hours setpoint PA07=0.
- PA21 ≥ 3 , rotation at working hours, but hours setpoint PA23=0.

Evaporator pump for anti-freeze configuration alarm

- if PA09 = 2 and PA10 = 0
- if PA09 = 2 and PA10 $\neq 0$, but no probes selected by PA10 are configured for managing the function

Condenser pump for anti-freeze configuration alarm

- if PA25 = 2 and PA26 = 0
- if PA25 = 2 and PA26 $\neq 0$, but no probes selected by PA26 are configured for managing

ACF10

If CF04=0 (not condensation unit), no temperature control probe (in chiller mode ST09, in heat pump mode ST10) is configured correctly (it does not exist or is not NTC).

ACF11

Heat recovery enabled but

- Not all resources needed are defined in a circuit (condensing probe, heat recovery request d.i. heat recovery relay).
If rC01=3, condensing probe not configured (AI type=28...31).
If rC01≠3, DI heat recovery request not configured (DI type=31...32).
- Free cooling or domestic hot water is enabled (FC01≠0 or FS01≠0).

ACF12

At least one inverter exist in the unit:

- Unit configured as Moto-condensing unit (CF04=1) or not using proportional temperature regulation (ST11≠0).
- For the compressor with inverter, no relevant resource configured. Such as compressor modulating output (AO type=9...10 or 20...21), compressor direct start-up relay (e.g. for comp1, DO type=44).

For relay Management VI valve 14 (DO type=89) and Management VI valve 16 (DO type=91), one relay is configured while another one is not configured.

ACF13

One of 6 compressors weight is different to 0. Parameters CO19...CO24 are not all set to 0.

ACF14

The temperature control has been configured on two circuits (ST12 = 1) but:

- the second circuit is not configured
- free cooling or recovery or domestic hot water are enabled (FC01≠0 or rC01≠0 or FS01≠0)

ACF15

Free cooling enabled but:

If FC01=1/2/3:

- the on/off valve (DO type=22) and the damper proportional output (AO type=3 and 14) are not defined
- the evaporator water inlet (AI type=7) not configured
- if CF01≠0, system water inlet temperature probe not configured (AI type=17)
- 2 external air temperature probes are all not configured (AI type=18 and 19)

If FC01=4, any resource below is not configured:

- system water inlet temperature probe (AI type=17)
- external air temperature probe (AI type=18)
- external air temperature probe (AI type=19)
- on/off valve (DO type=22) and ON/OFF fan (DO type=23)
- free-cooling mixer valve (AO type=3 or 14)

ACF16

Production of domestic hot water enabled (FS01≠0) but:

- the unit is configured as air/air (CF01 = 0)
- the domestic hot water pump outlet relay (DO type=43) or ON/OFF valve 1 for domestic water production (DO type=36) are not defined
- the domestic hot water regulation probe 1(AI type=24) is not defined
- FS01=2 and PA01=2 and FS49=0

	<p>ACF17</p> <ul style="list-style-type: none"> one or more pressure probes defined on a XEV20D module which is not configured by parameters Et09 – Et12 when SP01 <=1 and Et02#3 or when SP01>=2 and Et02#4, configured XEV20D probes as pressure type. <p>ACF18 If stepless compressor is enabled (SL01#0):</p> <ul style="list-style-type: none"> SL06>=SL07*10 ST11 ≠ 2 (2=neutral zone regulation) In one circuit, more than one compressor is configured (CF05...CF06>1) compressor is configured but relevant relay Compressor 1...2 intermittent valve is not configured (DO type=32...33). <p>ACF19 Probe selected by Un05 is not configured. Probe selected by Un10 is not configured.</p>
Display in keyboard	Conf AL1...Conf AL19
Cause of activation	Incorrect programming
Reset	Correct programming
Reset	Automatic
Icon	 flashing
Action	Alarm relay (DO type=1) + buzzer activated
Regulators	
Alarm	Relay + buzzer activated
Other loads	Off

11.42 FUNCTION NOT AVAILABLE ALARM

Alarm code	AfnA (Function not available alarm)
Display in keyboard	Func.not available
Cause of activation	<p>Incorrect parameter configuration, enabled some function that not available yet.</p> <ul style="list-style-type: none"> Set ST11 >2 Set DP05-DP08 value >0 Set SP02 =6 Set SP12=1 Set CO19-CO24 value >0 If CO12=2 (Star-delta start-up), relay Star-delta relay is no configured on board, they are configured in expansion IO board. If SL01 ≠0(stepless compressor enabled) <ul style="list-style-type: none"> CO09=1/3. No relays configured as Compressor 1...2 Unloader 1(DO type=47,54) Relays (Screw) Compressor 1...2 intermittent valve (DO type=32-33) are not configured on board, they are configured in expansion IO board. Relays Compressor 1...2 Unloader 2(DO type=48,55) are not configured on board, they are configured in expansion IO board.
Reset	Correct programming
Reset	Automatic
Icon	 flashing
Action	Alarm relay (DO type=1) + buzzer activated

Regulators	
Alarm	Relay + buzzer activated
Other loads	Off

11.43 NOTE: ALARM RELAY AND BUZZER

The alarm relay working is enabled with at least one relay configured as alarm

Alarm relay/buzzer outlet

ON if...	<ol style="list-style-type: none"> In the presence of active alarms In the presence of alarms not reset
OFF if..	<ol style="list-style-type: none"> In absence of alarms In stand-by or ON - remote OFF if AL65=1 (buzzer) pressing one of the keys even in the presence of non-resettable alarms

12. NO VOLTAGE

On restore:

- The device goes to the status preceding the power cut.
- If a defrost cycle is progress the cycle is reset.
- All timings in progress are annulled and re-initialised.
- If a manual reset alarm is present, the alarm status is maintained until the key is used to restore conditions.

13. AUTOMATIC TO MANUAL RESET ALARMS DIAGNOSTICS

N° OCCURRENCES PER HOUR

The observation interval is a time window. The length is one hour. It is divided into 60 intervals, 1 minute each.

This time window is slidable, it always cover the latest hour. See graph below:

1°Int	2°Int	3°Int	4°Int	5°Int	6°Int	7°Int	8°Int	9°Int	10°Int	...	55°Int	56°Int	57°Int	58°Int	59°Int
-------	-------	-------	-------	-------	-------	-------	-------	-------	--------	-----	--------	--------	--------	--------	--------

During one interval (1 minute), if the alarm is active, this interval will be marked as “active”. Then count all “active” intervals number of the latest hour.

If the total number does not exceeds the threshold set, it means this alarm is not frequently occur. Once it became not active, it will disappear immediately.

For example: See graph below (assume threshold set = 5. Active alarms are marked with ACT):

The total number of active intervals is 3. It is less than 5. So this alarm is automatic reset.

1°Int	2°Int	3°Int	4°Int	5°Int	6°Int	7°Int	8°Int	9°Int	10°Int	...	55°Int	56°Int	57°Int	58°Int	59°Int
	ACT	ACT	ACT												

If the total number exceeds the threshold set, it means this alarm occurs very frequent. There maybe some serious situation lies in the unit. So even when this alarm becomes not active, it does not disappear. It will becomes “Resettable”. Only by pressing a “RST” key in the keyboard can cancel this alarm.

For example: See graph below (assume threshold set = 5. Active alarms are marked with ACT):

The total number of active intervals is 7. It exceeds 5. So this alarm becomes to manual reset.

1°Int	2°Int	3°Int	4°Int	5°Int	6°Int	7°Int	8°Int	9°Int	10°Int	...	55°Int	56°Int	57°Int	58°Int	59°Int
	ACT	ACT	ACT			ACT	ACT	ACT	ACT						

14. OUTPUTS BLOCK TABLE

The alarm codes and signals are made up from letters and numbers that identify the different types.

14.1 CIRCUIT "A" OUTPUTS ALARM BLOCK TABLE

Code Alarm	Alarm description	Comp.	Heaters Anti-freeze boiler	Heaters support	Flow fan evap. pump	Cond. pump	Cond. ventil. Cir1 Cir2	Auxiliary relay
AP1	PB1 probe	Yes	Yes (1)	Yes			Yes	Yes (2)
AP2	PB2 probe	Yes	Yes (1)	Yes			Yes	Yes (2)
AP3	PB3 probe	Yes	Yes (1)	Yes			Yes	Yes (2)
AP4	PB4 probe	Yes	Yes (1)	Yes			Yes	Yes (2)
AP5	PB5 probe	Yes	Yes (1)	Yes			Yes	Yes (2)
AP6	PB6 probe	Yes	Yes (1)	Yes			Yes	Yes (2)
AP11	Expansion1 probe1	Yes	Yes (1)	Yes			Yes	Yes (2)
AP12	Expansion1 probe2	Yes	Yes (1)	Yes			Yes	Yes (2)
AP13	Expansion1 probe3	Yes	Yes (1)	Yes			Yes	Yes (2)
AP14	Expansion1 probe4	Yes	Yes (1)	Yes			Yes	Yes (2)
AP15	Expansion1 probe5	Yes	Yes (1)	Yes			Yes	Yes (2)
AP16	Expansion1 probe6	Yes	Yes (1)	Yes			Yes	Yes (2)
AP17	Expansion1 probe7	Yes	Yes (1)	Yes			Yes	Yes (2)
AP39	XEV20D 1 probe1	Yes	Yes (1)	Yes			Yes	Yes (2)
AP40	XEV20D 1 probe2	Yes	Yes (1)	Yes			Yes	Yes (2)
AP41	XEV20D 1 probe3	Yes	Yes (1)	Yes			Yes	Yes (2)
AP42	XEV20D 1 probe4	Yes	Yes (1)	Yes			Yes	Yes (2)
AP43	XEV20D 2 probe1	Yes	Yes (1)	Yes			Yes	Yes (2)
AP44	XEV20D 2 probe2	Yes	Yes (1)	Yes			Yes	Yes (2)
AP45	XEV20D 2 probe3	Yes	Yes (1)	Yes			Yes	Yes (2)
AP46	XEV20D 2 probe4	Yes	Yes (1)	Yes			Yes	Yes (2)
AEFL	Evaporator flow switch alarm	Yes	Yes (boiler)		Yes (3)		Yes	
ACFL	Condenser flow switch alarm	Yes				Yes (3)	Yes	
AtSF	Supply fan circuit breaker alarm	Yes		Yes	Yes		Yes	
AEUn	Evaporator unloading signalling							
AtE1	Evaporator n° 1 water pump circuit breaker	Yes (4)	Yes (boiler) (5)		Yes		Yes	
AtE2	Support evaporator n° 2 water pump circuit breaker	Yes (4)	Yes (boiler) (5)		Yes		Yes	
AtC1	Condenser n° 1 water pump circuit breaker	Yes (4)				Yes	Yes	
AtC2	Support condenser n° 2 water pump circuit breaker	Yes (4)				Yes	Yes	
AEP1	Evaporator n° 1 water pump maintenance							
AEP2	Support evaporator n° 2 water pump maintenance							
ACP1	Condenser n° 1 water pump maintenance							
ACP2	Support condenser n° 2 water pump maintenance							
AHFL	Domestic hot water pump flow switch alarm							

APFL	Solar panels pump flow switch alarm							
AEht	Evaporator water inlet high temperature alarm	Yes						
AET1	XEV20D 1 not connect alarm	Yes						
AET2	XEV20D 2 not connect alarm	Yes						
AEM1	IProEX60D 1 not connect alarm	Yes						
AFFC	Anti-freeze alarm in free-cooling							
Atrb	Boiler overload alarm	Yes		Yes				
ALcb	Boiler lock alarm	Yes		Yes				
AfnA	Function not available alarm	Yes			Yes	Yes	Yes	Yes
APS	Phases sequence alarm	Yes			Yes	Yes	Yes	Yes
AFr	Network frequency alarm	Yes			Yes	Yes	Yes	Yes
ALc1	Generic alarm 1	Yes			Yes	Yes	Yes	Yes
ALc2	Generic alarm 2	Yes			Yes	Yes	Yes	Yes
ACF1	Configuration alarm	Yes			Yes	Yes	Yes	Yes
ACF2	Configuration alarm	Yes			Yes	Yes	Yes	Yes
ACF3	Configuration alarm	Yes			Yes	Yes	Yes	Yes
ACF4	Configuration alarm	Yes			Yes	Yes	Yes	Yes
ACF5	Configuration alarm	Yes			Yes	Yes	Yes	Yes
ACF6	Configuration alarm	Yes			Yes	Yes	Yes	Yes
ACF7	Configuration alarm	Yes			Yes	Yes	Yes	Yes
ACF8	Configuration alarm	Yes			Yes	Yes	Yes	Yes
ACF9	Configuration alarm	Yes			Yes	Yes	Yes	Yes
ACF10	Configuration alarm	Yes			Yes	Yes	Yes	Yes
ACF11	Configuration alarm	Yes			Yes	Yes	Yes	Yes
ACF12	Configuration alarm	Yes			Yes	Yes	Yes	Yes
ACF13	Configuration alarm	Yes			Yes	Yes	Yes	Yes
ACF14	Configuration alarm	Yes			Yes	Yes	Yes	Yes
ACF15	Configuration alarm	Yes			Yes	Yes	Yes	Yes
ACF16	Configuration alarm	Yes			Yes	Yes	Yes	Yes
ACF17	Configuration alarm	Yes			Yes	Yes	Yes	Yes
ACF18	Configuration alarm	Yes			Yes	Yes	Yes	Yes
ACF19	Configuration alarm	Yes			Yes	Yes	Yes	Yes

0= if configured as temperature control

1= If the probe configured for control of the anti-freeze - boiler and Ar10 = 0

2= If the probe configured for control of the auxiliary relay output

3= With manual reset alarm

4= Compressors off with just n° 1 water pump configured or with n° 2 water pumps configured and both with circuit breaker alarms

5= boiler heaters off only with n° 1 water pump configured or with n° 2 water pumps configured and both circuit breaker alarms (in this case the boiler heaters are only activated by the anti-freeze set protecting the evaporator)

14.2 CIRCUIT "B" OUTPUTS ALARM BLOCK TABLE

Code Alarm	Alarm description	Compressors Circuit (n)	Condensation Ventilation Circuit (n)
b(n)HP	Circuit high pressure pressure switch(n)	Yes	Yes after 60 secs.
b(n)LP	Circuit low pressure pressure switch(n)	Yes	Yes
b(n)AC	Anti-freeze in cooling circuit (n)	Yes	Yes
b(n)AH	Anti-freeze in heating circuit (n)	Yes	Yes
b(n)A	Low temperature/anti-freeze alarm in circuit (n)	Yes	Yes
b(n)hP	Condensation high pressure transducer circuit(n)	Yes	Yes after 60 secs.
b(n)IP	Circuit (n) low condensation/evaporator temperature NTC probe	Yes	Yes
b(n)tF	Circuit ventilation circuit breaker alarm (n)	Yes	Yes
b(n)dF	Circuit defrost alarm signal(n)		
b(n)Cu	Unloading signal due to circuit (n) condensation temp. press.		
b(n)Eu	Unloading signal due to circuit (n) evaporator low temp.		
b(n)rC	Circuit (n) heat recovery disabling signal		
b(n)PH	Circuit pump down stopping alarm (n)	Yes	Yes
b(n)PL	Circuit pump down start-up alarm (n)	Yes	Yes

Where the letter (n) identifies the circuit n° 1 or circuit n° 2

14.3 COMPRESSOR "C" ALARMS OUTPUTS BLOCK TABLE

Code Alarm	Alarm description	Compressor (n)	Circuit compressors not affected
C(n)HP	Compressor high pressure pressure switch(n)	Yes	
C(n)oP	Compressor (n) pressure switch/oil float	Yes	
C(n)tr	Compressor circuit breaker alarm (n) with AL47 = 0 - 1	Yes	
C(n)tr	Compressor circuit breaker alarm (n) with AL47 ≠ from 0	Yes	Yes
C(n)dt	Compressor high discharge temperature	Yes	
C(n)Mn	Compressor maintenance (n)		

Where the letter (n) identifies the compressor n° 1, 2, 3, 4, 5

	
<p>Dixell S.r.l. - Z.I. Via dell'Industria, 27 - 32010 Pieve d'Alpago (BL) ITALY Tel. +39.0437.9833 r.a. - Fax +39.0437.989313 - EmersonClimate.com/Dixell - dixell@emerson.com</p>	