

REFSCALE-S

4688867

EN

INSTRUCTION MANUAL

Electronic Charging Scale

DE

BEDIENUNGSANLEITUNG

Elektronische Füllwaage

FR

MODE D'EMPLOI

Balance électronique

IT

ISTRUZIONE PER L'USO

Bilancia elettrica

ES

MANUAL DE INSTRUCCIONES

Báscula eléctrica



1.0	Introduction	1
2.0	General information	1
3.0	Specification	5
4.0	Product and part description	6
4.1	Product	6
4.2	Buttons and navigation	7
4.3	Display	8
5.0	Transport, packaging and storage	11
5.1	Transport, packaging	11
6.0	Commissioning	12
6.1	Functions	13
6.2	Connections	26
7.0	Battery management	27
8.0	Stable measured	27
9.0	Error	27
9.1	Overload display	28
9.2	Troubleshooting Guide	28
10.0	Garantie	29
11.0	Return disposal	29
12.0	Spare Parts / Accessories	30

1.0 Introduction



Congratulations on your purchase of this device. The REFSCO REFSCALE-S is equipped with a weight sensor equipped with a strain gauge and gives you the ability to connect with the REFSCO REF MESH App and/or with the REFSCO REF MATE.

The latest manual can be downloaded from www.refco.ch.

2.0 General information

Before you start working with the REFSCALE-S, please read the operating instructions carefully. They contain important information for the successful operation, maintenance and disposal of the electronic charging scale.









Conformity

	<p>This device complies with the relevant European directives. The Declaration of Conformity is available from the specified contact details or on the REFSCO website.</p>
	<p>This device complies with Part 15 of the FCC Rules. It should be operated under the following conditions:</p> <ol style="list-style-type: none"> (1) This device may not cause harmful interference, and (2) This device must be able to withstand interference, including interference that may result in errors during operation. <p>FCC ID: XPYNINAB1</p>
	<p>This device complies with Industry Canada's license-exempt RSS standards. It should be operated under the following conditions:</p> <ol style="list-style-type: none"> (1) This device may not cause harmful interference, and

	<p>(2) This device must be able to withstand interference, including interference that may result in errors during operation.</p> <p>IC ID: 8595A-NINAB1</p>
	<p>RCM: Regulatory Compliance Mark</p> <p>This device complies with the requirements of the RCM regulations.</p>
<p>RoHS</p>	<p>RoHS: Restriction of Hazardous Substances</p> <p>This device meets the requirements of the RoHS EU directive.</p> <p>RoHS 2011/65/EU including 2015/863/EU</p> <p>The device does not contain any prohibited substances above the maximum permissible values.</p>
<p>REACH</p>	<p>In accordance with Article 33 of REACH Regulation 1907/2006, we confirm that this device and its packaging complies with Article 57 of REACH Regulation 1907/2006.</p> <p>This device and its packaging do not contain any of the SVHC specified in the current candidate list (Article 59) at concentrations above 0.1%.</p>

Important Safety Instructions

Read all safety instructions thoroughly and comply with them.

	Warning!	
	The symbol <i>Warning!</i> indicates a possible dangerous situation that can lead to serious injury if not avoided.	
	Danger!	
Safety instructions:		
	Do not expose the electronic charging scale to rain.	
	Always wear protective goggles and gloves when working with the electronic charging scale	
		
	REFCO products are specifically designed and manufactured to be handled by trained refrigeration technicians. Due to the high pressures and gases used in refrigeration systems, REFCO declines all responsibility and liability for accidents, injuries and death.	
	REFCO expressly states that the products must only be used by professionally trained experts. No use by children or unqualified persons.	
	The electronic charging scale must not be used in EX zones.	
	If the electronic charging scale falls, it must be calibrated.	

Intended Use

The electronic charging scale has been developed for measuring weights in mobile and stationary refrigeration systems. Only trained refrigeration technicians are permitted to use this REFCO product. Observe the operating conditions from the data sheet.

Humidity can cause surface changes to the aluminum housing, which is harmless. To avoid it, the device must be dried while damp.

3.0 Specification

Property	Value
Capacity	0 - 110 kg / 243 lb
Resolution	2 g
Accuracy	0.05 % or 10 g
Units	kg / lb / oz / lb&oz
Power supply	4 x 1.5 V AA Battery or USB Micro Type B
App	REFMESH
Wireless range	100 m 330 ft
Permissible humidity during operation	0 – 90 %
Operating temperature	-20 °C – 50 °C -4 °F – 122°F
Storage temperature	-40 °C – 60 °C -40 °F – 140 °F
Dimensions	36.5 cm x 26.1 cm x 3.9cm 14.4" x 10.3" x 1.5"
Weight	3.2 kg / 7 lb
Battery runtime	50 h





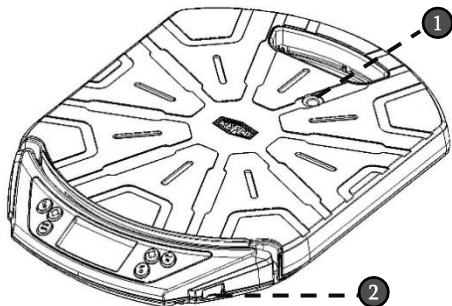

4.0 Product and part description

4.1 Product



- 1 M10 thread for attaching the 10612-REF valve for refrigerant bottles.
- 2 USB-connection micro type B.

4.2 Buttons and navigation

operation	
 <p>On/Off and Backlight Button</p> <p><i>Press for 2 seconds:</i> Device on</p> <p><i>Press briefly</i> Backlight On/Off</p> <p><i>Press long and hold:</i> Device off</p>	 <p>Tara and Zero Button</p> <p><i>Press briefly:</i> Tare</p> <p><i>Press and hold:</i> Zero</p>
 <p>Enter and Menu Button</p> <p><i>Press and hold:</i> Enter/exit the menu</p> <p><i>Press briefly:</i> In menu mode: Enter / confirm. In work mode: save current data.</p>	 <p>Hold and Alarm Button</p> <p><i>Press briefly:</i> <i>Hold function / hold current value</i></p> <p><i>Press and hold</i> Alarm on / off</p>
 <p>Navigation Button left / top</p> <p>Navigate through the screens and settings</p>	 <p>Navigation Button right / bottom</p> <p>Navigate through the screens and settings</p>

4.3 Display



4.3.1 Primary Display



Display of the measured value with the corresponding units and tare display.

4.3.2 Secondary Display with Functional status

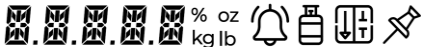

Display of an auxiliary value

% oz
kg lb

Auxiliary display unit



Alarm function is switched on



Alarm triggered



Tank Capacity function is switched on



Valve function: valve open



Valve function: valve closed



Hold function is active

Status bar



“Stable measured value” symbol / displayed when the measured value is stable



“Wireless connection active” symbol / displayed when the radio connection is switched on



“Valve connected” symbol / displayed when the scale is connected to an external valve.



“Error” symbol / displayed when something is not OK



“USB” symbol / displayed when powered via USB



“Battery” symbol / indication of the battery charge status

Menu



Menu symbol / indicates whether the scale is in menu mode.



Alarm symbol / display whether the scale is in the configuration for the alarm function.



Tank capacity symbol / display whether the scale is in the configuration for the tank capacity function. Parameters: 100%, 0%, On/Off



Wireless configuration symbol / indicates that the scale is in the configuration for the radio connection. Parameters: BLE On/OFF/APP/LE



Unit of measurement Symbol / indicates whether the scale is in the configuration for unit of measurement.



Calibration or gravity symbol / indicates that the scale is in the configuration for calibration or gravity.



Valve symbol / indicates whether the scale is in the configuration for valve control.



Memory symbol / indicates whether the scale is in memory mode.



Information symbol / indicates whether the scale is in information mode.

5.0 Transport, packaging and storage

5.1 Transport, packaging

Storage conditions must be adhered during transport. During transport, the REFSCALE-S must be placed in the corresponding suitcase.

5.2 Storage

The storage temperatures (chapter 3) must be adhered. If the REFSCALE-S will not be used for a long period of time, the batteries must be removed from the battery compartment.

6.0 Commissioning

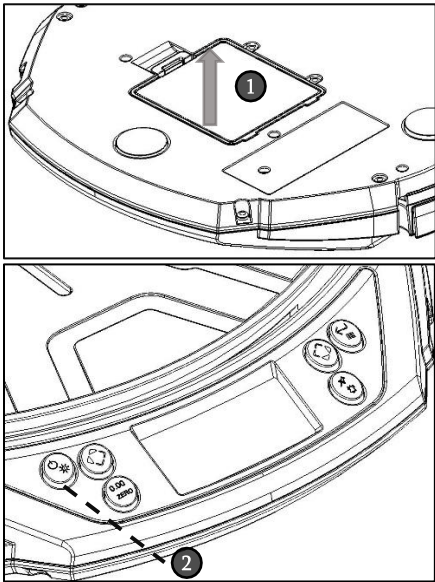

- 1** Remove the battery cover and pull out the contact break.
- 2** Press button for 2 seconds and wait until the display symbols appear.

6.1 Functions

On / Off / Lighting

Press for 2 seconds  to switch on the device.

Long press  to turn off the device.

The backlight can be switched on and off by briefly pressing



Set Tare

Tare / 0.00

Resets the scale to zero, regardless of the weight. This function is used, for example, to subtract the empty cylinder weight.

Net

When taring the scale with a weight on the platform, "Net" appears on the display.



By increasing the number of filled/emptied cylinder, while using the Hold function, the Net display also increases. This is possible up to Net 9. Then it starts again with Net 1.

ZERO

Resets the scale to zero if the weight display deviates from zero by a maximum of 125 grams. This function is used if a small deviation is displayed, when the scale is switched on.

Hold function















A special function on the REFSCALE-S allows you to freeze the value. This function can be used, for example, when filling or emptying the system when in case the gas cylinder is empty or full.

The function is activated by briefly pressing  and the symbol  appears on the display.

To deactivate the function, press again .

Alarm

With the REFSCALE-S a programmable alarm value can be set. The alarm will sound when the required value (either positive for increasing weight, or negative for decreasing weight) is reached. After 90% of the programmed value, an approaching alarm brings to your attention, with an alternating tone, that the required amount is nearly reached. While reaching 100%, a continuous tone sounds.

1.  press , enter the menu
2.  press , navigate to alarm
3.  press , confirm
4.  press , «SET» is displayed
5.  press , confirm «SET»
6.  press , Define the value at which the alarm should be triggered
7.  press , confirm value



The alarm value can only be entered as a positive value, but it counts in positive and negative direction.



If the unit is changed, the programmed value must be reset.











To activate or deactivate a programmed alarm, press and hold



for 3 seconds.











Deactivate / activate Alarm sound

In the Alarm mode, the acoustic sound can be deactivated and only a visual message is triggered on the display..

1.  press ; to enter the menu
2.  press  , navigate to alarm
3.  press  , confirm
4.  press  , navigate to  (sound deactivated)
5.  press  , confirm «sound deactivated»















The following symbol appears on the display, when the alarm is triggered: 

To reactivate the audible alarm/tone:

1.  press  , to enter the menu
2.  press  , navigate to alarm
3.  press  , confirm
4.  press  , navigate to  (sound activated)
5.  press  , confirm «sound activated»

Tank Capacity

It is often convenient to know the relative amount of gas remaining in a gas cylinder (tank). The REFSCALE-S Tank Capacity Mode allows a continuous display of the percentage of gas remaining in a tank. In order to compute the percentage accurately, the REFSCALE must be trained with the weights of an empty and full tank. To train the REFSCALE Tank Capacity Mode, perform the following steps:

1.  press , to enter the menu
2.  press , navigate to Tank Capacity
3.  press , confirm
4.  press , navigate to «SET»
5.  press , confirm
6. The display shows 0%, indicating that the weight of an empty container needs to be registered.
Place an empty gas cylinder (or a load equal to the weight of an empty gas cylinder) on the platform. Wait 5 seconds for the load to stabilize.
7.  press , confirm
8. The display shows 100%, indicating that the weight of a full cylinder needs to be registered.
Place a full gas cylinder (or a load equal to the weight of a full gas cylinder) on the platform. Wait 5 seconds for the load to stabilize.
9.  press , confirm
10. The training process is now completed and the 100% display goes out.

Tank Capacity Display

After 90% of the programmed value, an approaching alarm brings to your attention, with an alternating tone, that the required amount is nearly reached. The following symbol appears on the display, with the top horizontal bar starting to

flash: 

While reaching 100%, a continuous tone sounds and the symbol stops flashing.

Between 10% and 90 the following symbol is displayed: 











While approaching 10%, an approaching alarm brings to your attention, with an alternating tone, that the required amount is nearly reached. The following symbol appears on the display,

with the lowest horizontal bar starting to flash: 













While reaching 0%, the lowest horizontal bar from the symbol no longer visible.

Deactivate / activate Tank Capacity sound











In the Tank Capacity mode, the acoustic sound can be deactivated and only the visual message is triggered on the display..

1.  press ; to enter the menu
2.  press , navigate to Tank Capacity
3.  press , confirm
4.  press , navigate to  (sound deactivated)
5.  press , confirm «sound deactivated»

To reactivate the audible alarm/tone:











6.  press , to enter the menu
7.  press , navigate to Tank Capacity
8.  press , confirm
9.  press , navigate to  ; ;  (sound activated)
10.  press , confirm «sound activated»

Activate Tank Capacity











1.  press  , to enter the menu
2.  press  , navigate to Tank Capacity
3.  press  , confirm
4.  press  , navigate to «On»
5.  press  , confirm

From this point on, the numeric display shows the percentage of material remaining in the gas cylinder from 0% to 100%.

Deactivate Tank Capacity

1.  press  , to enter the menu
2.  press  , navigate to Tank Capacity
3.  press  , confirm
4.  press  , navigate to «OFF»
5.  press  , confirm











Wireless connection

1.  press , to enter the menu
2.  press , navigate to Wireless connection
3.  press , confirm
4.  press , to select «On / OFF»
5.  press , to confirm selection

To establish a connection, the Wireless connection icon must flash, indicating that the scale is searching for a connection. Once a connection to a device is established, the icon lights up continuously.

















The connection to the scale is made via the REFMATE or the REFMESH. While the connection to an external valve (Valve control) takes place via the scale. If the Wireless configuration is Off, incoming and outgoing connections are not possible.

Units (kg / lb / oz / lb&oz)

1.  press , to enter the menu
2.  press , navigate to Units
3.  press , confirm
4.  press , to change the units
5.  press , to confirm the units

Calibration = Cal0











The REFSCALE-S is calibrated at the factory to provide high accuracy. While recalibration should seldom, if ever, be necessary, a field calibration is performed easily without sending the product to the manufacturer for service. A known calibration weight (in kilograms) is required to perform the field calibration the scale, and can be any value between 10 kg and 100 kg. Best accuracy is obtained by using the largest weight available. The calibration must be carried out using standardized weights. The REFSCALE-S must be placed on a firm, flat surface.

1. Remove all items from the platform.
2.  press , to enter the menu
3.  press , navigate to Calibration
4.  press , confirm
5.  press , navigate to «Cal0»
6.  press , confirm
7. Specify calibration weight by using , e.g. 20kg
8.  press , «Set 0kg» is displayed
9.  press , e.g. 20,000 kg is displayed
10. Put a weight of 20 kg on it. Wait 5 seconds for the load to stabilize.
11.  press , confirm
12. Display shows «SAVED»

Restoring Factory Gravitation = Call





If you make a mistake during the field calibrating with the REFSCALE-S, you can always restore the factory calibration of the scale.

To restore the factory settings perform the following steps:

1.  press  , to enter the menu
2.  press  , navigate to Calibration
3.  press  , confirm
4.  press  , navigate to «Call»
5.  press  , confirm











Gravity / GEO

Depending on the earth region where the REFSCALE-S is used, a different gravity prevails. Therefore different gravity values can be selected.

-  press **■**, to enter the menu
-  press **●**, navigate to Gravity
-  press **●**, confirm
-  press **●**, navigate to the desired gravity number / GEOx according to the table below.
-  press **●**, confirm

Gravity-Number	Value	City
GEO1	GEO1 = 9,80669 m/s ²	Zurich
GEO2	GEO2 = 9,81268 m/s ²	Berlin
GEO3	GEO3 = 9,80988 m/s ²	Paris
GEO4	GEO4 = 9,818349 m/s ²	Stockholm
GEO5	GEO5 = 9,81249 m/s ²	Warsaw
GEO6	GEO6 = 9,811897 m/s ²	London
GEO7	GEO7 = 9,80061 m/s ²	Washington
GEO8	GEO8 = 9,78741 m/s ²	Hong Kong
GEO9	GEO9 = 9,79652 m/s ²	Sydney

Valve control (Automatic valve under development)

1.  press  , to enter the menu
2.  press  , navigate to Valve control
3.  press  , confirm
4.  press  , navigate to On / OFF or SCAN
5.  press  , to confirm the desired function

On/OFF: Switching on or off the connection to the valve. The scale automatically tries to connect to a REFCO valve.

SCAN: Search and connect to the REFCO valve via Bluetooth.













If the Valve control is activated, the symbol «Valve connected»  on the display flashes. It now tries to connect to a valve. When it stops flashing, the valve is connected.

If the valve is open, the valve function is displayed with an arrow .









If the valve is closed, the valve function is displayed with an interruption .

Memory

In the work mode, the current data can be saved by pressing the Enter button . A maximum of 10 data can be saved. The data can be subsequently read from the Memory.

1.  press , to enter the menu
2.  press , navigate to Memory
3.  press , confirm
4.  press , navigate to the data
5.  press , to open the desired data
6.  press , to exit from the Memory

Information

1.  press , to enter the menu
2.  press , navigate to Information
3.  press , confirm
4.  press , to move between the information's

SW V: Current software version

HW V: Current hardware version

PAR. C: When recalibrating or changing the GEO value, the display increases.

6.2 Connections

With the REFSCALE-S it is possible to establish a connection to the REFSCO REF MESH App or to the REF MATE digital manifold. To connect to REF MESH or REF MATE, the Wireless connection icon must be flashing, which indicates that the scale is searching for a connection. As soon as a connection is established, the Wireless connection icon lights up continuously.

Connection to REF MESH

With the REF MESH you can easily establish a connection with the REFSCALE-S via the usual "connect" window on the REF MESH. Via REF MESH it is possible to set tare, use the hold function, set an alarm and save a value which can be shown in a report.

Connection to REF MATE

When the connection LED flashes you can easily search for a device with the REF MATE. If the REFSCALE-S is within the range, the device connects automatically. When the devices are connected, you can see the REFSCALE-S values on the REF MATE. On the REF MATE you have access to the additional screen by pressing the SWITCH button.

Recommendation

A connection of the REF MESH and the REF MATE to the REFSCALE-S at the same time is not possible. You can connect the REF MATE to the REFSCALE-S and the REF MESH to the REF MATE. The current measured value is displayed in all devices.

7.0 Battery management

To increase battery life, the REFSCALE-S has two functions:

Automatic shutdown:

After 30 minutes without any button operation and without any changes of the measured value, the device switches off. This only occurs if energy supply via inserted battery is selected.

Alternative power source:

Instead of using batteries, it is possible to power the REFSCALE-S via USB Micro Type B, e.g. B. via a power supply or a power bank.

8.0 Stable measured



Displayed when the measured value is stable and no changes happens.

Only in this state it is possible to calibrated the scale and to use the zero function. If this is not met, the scale must be re-aligned or restarted. The REFSCALE-S must be placed on a firm, flat surface and it must not experience any vibration.

9.0 Error



This is displayed when something is wrong.

The following errors can be the cause:

- Missing calibration
- Zero does not work: Exceeding the maximum permitted deviation limit of 125 grams
- No stable measurement: Scale is not placed on level or steady, the surface is not firm and flat.

9.1 Overload display

If the weight applied to the platform exceeds the maximum capacity of the REFSCALE-S (110 kg / 243 lb), the display will show "OOR", which means "Out of Range". This applies to the absolute weight measurement.



To avoid damage to the REFSCALE-S, remove the weight from the platform immediately.

9.2 Troubleshooting Guide

Failure	Troubleshooting
Device cannot be switched on	Battery inserted incorrectly. Battery contact break was not pulled out.
OOR	Weight over 110 kg. Reduce weight immediately.
Stable measured value is not met	Re-align the device. Restart the device.
Display does not change	Hold function is activated (Hold function symbol is displayed).
Bluetooth connection doesn't work	A device is already connected. This can be seen when the Wireless connection icon lights up continuously.
ZERO doesn't work	Exceeding the maximum permitted deviation limit of 125 g

10.0 Garanty

Your new, state-of-the-art REFSCALE-S has been developed in accordance with the latest findings in occupational physiology and ergonomics. REFCO Manufacturing Ltd has been certified according to DIN EN ISO 9001:2015. Regular quality control checks as well as an accurate manufacturing process guarantee reliable functionality and are the basis for the REFCO guarantee, in accordance with the General Terms and Conditions of Sale and Delivery applicable on the day of delivery. Excluded from the guarantee are damage caused by obvious maltreatment and wear and tear.

11.0 Return disposal

The REFCLAMP-S has been developed for long-term use. Attention was paid to energy saving and environmental compatibility at the material procurement and production stages. REFCO embraces its responsibility towards the environment, and has therefore been certified in accordance with DIN EN ISO 14001:2015. When decommissioning the device, the user must follow local disposal regulations. The housing is made out of Thermoplastic, Aluminum and Rubber.



12.0 Spare Parts / Accessories

Spare Parts	Part no.	Designation
Battery-Cover	4688813	REFSCALE-BATTERY-COVER
Case	4688963	REFSCALE-S-CASE
Accessories	Part no.	Designation
Filling adapter for refrigerant cans	4688637	10612-REF-ACME-LH (1/2"-16G)
	4682773	10612-REF-1/4"SAE
	4677027	10612-REF
Support device for refrigerant cans	4688316	10612-50-ACME-LH
	4682781	10612-50-1/4"SAE
	9885074	10612-50

1.0	Einleitung	3
2.0	Allgemeines	3
3.0	Technische Daten	7
4.0	Produkt und Teilbeschreibung	8
4.1	Produkt	8
4.2	Knöpfe und Navigation	9
4.3	Display	10
4.4	Hauptanzeige	10
4.5	Nebenanzeige mit Funktionsstatus	11
5.0	Transport, Verpackung und Lagerung	13
5.1	Transport, Verpackung	13
5.2	Lagerung	13
6.0	Inbetriebnahme	14
6.1	Funktionen	15
6.2	Verbindungen	28
7.0	Batterie-Management	29
8.0	Stabiler Messwert	29
9.0	Error / Fehler	29
9.1	Überlast-Anzeige	30
9.2	TROUBLESHOOTING-GUIDE	30
10.0	Garantie	31
11.0	Rücksendung und Entsorgung	31
12.0	Ersatzteile und Zubehör	32

1.0 Einleitung



Wir gratulieren recht herzlich zum Kauf dieses Geräts. Die REFCO REFSCALE-S ist mit einem Gewichtssensor mit Dehnmess-Streifen ausgestattet und bietet dir die Möglichkeit, eine Verbindung mit der REFCO REF MESH App und/oder mit dem REFCO REF MATE herzustellen.

Die letztgültige Bedienungsanleitung kann über www.refco.ch herunter geladen werden.

2.0 Allgemeines

Bevor Sie die Arbeit mit der REFSCALE-S beginnst, lies bitte aufmerksam die Bedienungsanleitung. Sie enthält wichtige Informationen für die erfolgreiche Bedienung, Wartung und Entsorgung der elektronischen Füllwaage.











Konformität

	<p>Dieses Gerät erfüllt die Konformität mit den relevanten europäischen Richtlinien. Die Konformitätserklärung ist über den genannten Kontakt oder auf der REFCO Website abrufbar.</p>
	<p>Dieses Gerät erfüllt die Anforderungen gemäss Teil 15 der FCC-Bestimmungen. Der Betrieb erfolgt unter nachstehenden Bedingungen:</p> <ol style="list-style-type: none"> (1) Dieses Gerät darf keine Interferenzen erzeugen, und (2) Dieses Gerät muss Interferenzen verkräften können, einschliesslich Interferenzen, die zu Fehlern im Betrieb führen können. <p>FCC ID: XPYNINAB1</p>
	<p>Dieses Gerät entspricht den lizenzfreien RSS-Standards gemäss Industry Canada. Der Betrieb erfolgt unter nachfolgenden Bedingungen:</p>

<h1>IC</h1>	<p>(1) Dieses Gerät darf keine Interferenzen erzeugen, und</p> <p>(2) Dieses Gerät muss Interferenzen verkräften können, einschliesslich Interferenzen, die zu Fehlern im Betrieb führen können.</p> <p>IC ID: 8595A-NINABI</p>
	<p>RCM: Regulatory Compliance Mark</p> <p>Dieses Gerät entspricht den Anforderungen der RCM-Bestimmungen.</p>
<h1>RoHS</h1>	<p>RoHS: Restriction of Hazardous Substances</p> <p>Dieses Gerät erfüllt die Bestimmungen der EU-Richtlinie RoHS.</p> <p>RoHS 2011/65/EU beinhaltet 2015/863/EU.</p> <p>Das Gerät enthält keine verbotenen Substanzen oberhalb der Grenzwerte.</p>
<h1>REACH</h1>	<p>Gemäss Artikel 33 der REACH-Verordnung 1907/2006 bestätigen wir, dass dieses Gerät und die Verpackung mit Artikel 57 der REACH-Verordnung 1907/2006 übereinstimmen.</p> <p>Dieses Gerät und die Verpackung enthalten keinerlei SVHC, spezifiziert in der aktuellen Kandidatenliste (Artikel 59), mit einer Konzentration von über 0,1 %.</p>

Wichtige Sicherheitshinweise

Bitte lesen Sie alle Sicherheitshinweise gründlich durch und halten Sie diese ein:

	Warnung!	
	... weist auf eine möglicherweise gefährliche Situation hin, die zu schweren Verletzungen führen kann, wenn sie nicht gemieden wird.	
	Gefahr!	
Sicherheitshinweise:		
	Die elektronische Füllwaage darf nicht für andere Zwecke ausserhalb des Klima-Kältebereichs eingesetzt werden.	
	Die elektronische Füllwaage darf nicht Regen ausgesetzt werden.	
	Beim Arbeiten mit der elektronische Füllwaage sind immer eine Schutzbrille und Handschuhe zu tragen.	
		
	REFCO-Produkte werden speziell für die Handhabung durch ausgebildete Kältetechniker entwickelt und hergestellt. Aufgrund der hohen Drücke sowie der Gase, die in Kältesystemen verwendet werden, lehnt REFCO jede Verantwortung und Haftung bei Unfällen, Verletzungen und Tod ab.	
	REFCO weist ausdrücklich darauf hin, dass die Produkte ausschliesslich durch professionell ausgebildete Fachleute einzusetzen sind. Kein Gebrauch für Kinder und nicht befähigte Personen.	
	Die elektronische Füllwaage darf nicht in EX-Zonen verwendet werden.	
	Bei einem Sturz der elektronische Füllwaage muss diese kalibriert werden.	

Bestimmungsgemässer Gebrauch

Die elektronische Füllwaage wurde zur Messung der Gewichtszustände in mobilen und stationären Kühlsystemen und in Wärmepumpen entwickelt. Dieses REFCO-Produkt darf nur von geschulten Kältetechnikern verwendet werden. Beachte die Einsatzbedingungen aus Datenblatt.

Feuchtigkeit verursacht eine Oberflächen-Veränderung am Aluminium Gehäuse, was unbedenklich ist. Um dies zu vermeiden, muss das Gerät im Feuchten Zustand getrocknet werden.

3.0 Technische Daten

Eigenschaft	Wert
Messbereich	0 - 110 kg / 243 lb
Auflösung	2 g
Messgenauigkeit	0.05 % oder 10 g
Einheiten	kg / lb / oz / lb&oz
Stromversorgung	4 x 1.5 V AA Batterien oder USB Micro Typ B
App	REFMESH
Drahtlosreichweite	100 m 330 ft
Zulässige Feuchtigkeit im Betrieb	0 – 90 %
Betriebstemperatur	-20 °C – 50 °C -4 °F – 122 °F
Lagertemperatur	-40 °C – 60 °C -40 °F – 140 °F
Abmessung	36.5 cm x 26.1 cm x 3.9 cm 14.4" x 10.3" x 1.5"
Gewicht	3.2 kg / 7 lb
Batterie Laufzeit	50 h

4.0 Produkt und Teilbeschreibung



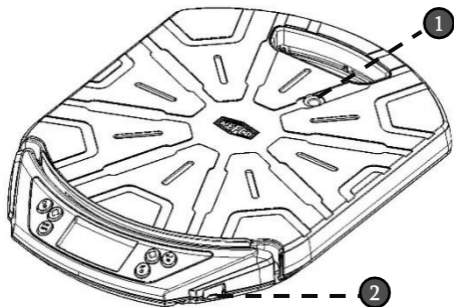

4.1 Produkt



1 M10 Gewinde zum Befestigen des Ventils 10612-REF für Druckdosen.

2 USB-Anschluss Micro Typ B.

4.2 Knöpfe und Navigation

Bedienung	
 <p>Knopf für On/Off und Beleuchtung</p> <p><i>Drücken für 2 Sekunden:</i> Gerät ein</p> <p><i>Kurz drücken:</i> Beleuchtung ein/aus</p> <p><i>Lang drücken:</i> Gerät aus</p>	 <p>Knopf für Tara und Zero</p> <p><i>Kurz drücken:</i> Tara</p> <p><i>Lang drücken:</i> Zero</p>
 <p>Knopf für Enter und Menu</p> <p><i>Lang drücken:</i> Ein-/Austreten vom Menu</p> <p><i>Kurz drücken:</i> Im Menübetrieb, Enter / Bestätigung.</p> <p>Im Arbeitsbetrieb, aktuelle Daten speichern..</p>	 <p>Knopf für Halten und Alarm</p> <p><i>Kurz drücken:</i> Hold Funktion / aktueller Wert halten</p> <p><i>Lang drücken:</i> Alarm an / aus</p>
 <p>Knopf für Navigation links / oben</p> <p>Navigieren durch die Bildschirme und Einstellungen</p>	 <p>Knopf für Navigation rechts / unten</p> <p>Navigieren durch die Bildschirme und Einstellungen</p>

4.3 Display



4.4 Hauptanzeige



Anzeige des Messwerts mit den entsprechenden Einheiten und Tara Anzeige.

4.5 Nebenanzeige mit Funktionsstatus

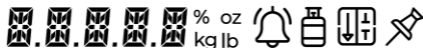

Anzeige eines Hilfswertes

% oz
kg lb

Einheit zur Hilfsanzeige



Alarm Funktion ist eingeschaltet



Alarm ausgelöst



Tank-Kapazität Funktion ist eingeschaltet



Ventil Funktion: Ventil offen



Ventil Funktion: Ventil geschlossen



Haltefunktion ist aktiv

Statusbar



„Stabiler Messwert“ Symbol / Wird angezeigt, wenn der Messwert stabil ist.



„Funk Verbindung Aktiv“ Symbol / Anzeige, wenn die Funkverbindung eingeschaltet ist.



„Ventil Verbunden“ Symbol / Anzeige, wenn die Waage mit einem externen Ventil verbunden ist.



„Error“ Symbol / Wird angezeigt, wenn etwas nicht OK ist.



„USB“ Symbol / Anzeige, wenn Stromversorgung über USB erfolgt



„Battery“ Symbol / Anzeige des Ladezustands der Batterie

Menü



Menü Symbol / Zeigt an, ob sich die Waage im Menübetrieb befindet.



Alarm Symbol / Anzeige, ob sich die Waage in der Konfiguration für die Funktion Alarm befindet.



Tank-Kapazität Symbol / Anzeige, ob sich die Waage in der Konfiguration für die Funktion Tank-Kapazität befindet. Parameter: 100%, 0%, On/Off



Symbol Funkkonfiguration / Anzeige, dass sich die Waage in der Konfiguration für die Funkverbindung befindet. Parameter: BLE On/OFF



Masseinheit Symbol / Anzeige, ob sich die Waage in der Konfiguration für Masseinheit befindet.



Symbol Kalibrierung oder Gravitation / Anzeige, dass sich die Waage in der Konfiguration für die Kalibrierung oder Gravitation befindet.



Ventil Symbol / Anzeige, ob sich die Waage in der Konfiguration für die Ventilansteuerung befindet.



Speicher Symbol / Zeigt an, ob sich die Waage im Speichermodus befindet.



Information Symbol / Zeigt an, ob sich die Waage im Infomodus befindet.

5.0 Transport, Verpackung und Lagerung

5.1 Transport, Verpackung

Die Lagerbedingungen müssen während des Transports eingehalten werden. Während des Transports muss die REFSCALE-S im dazugehörigen Koffer eingelegt sein.

5.2 Lagerung

Die Lagertemperaturen (Kapitel 3) müssen eingehalten werden. Wenn die REFSCALE-S über einen längeren Zeitraum nicht benutzt wird, sind die Batterien aus dem Batteriefach zu entfernen.

6.0 Inbetriebnahme

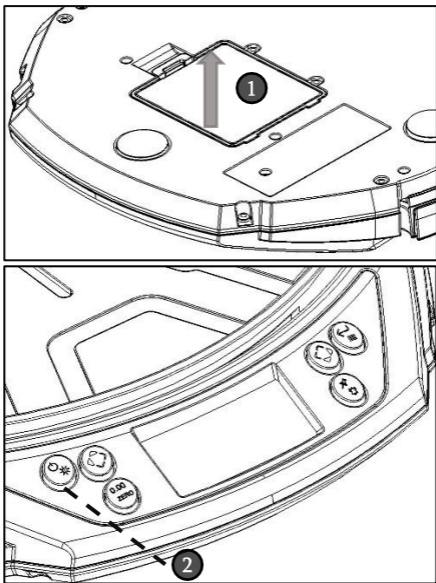



- 1 Batteriedeckel entnehmen und den Kontaktunterbruch herausziehen.
- 2 Knopf für 2 Sekunden drücken und warten bis Display-Symbole angezeigt werden.

6.1 Funktionen

Einschalten / Ausschalten / Beleuchtung

Für 2 Sekunden drücken  um das Gerät einzuschalten.

Lang drücken  um das Gerät auszuschalten.

Die Hintergrundbeleuchtung kann durch kurzes drücken von  ein und ausgeschaltet werden.

Tarieren

Tara / 0.00

Zurücksetzen der Waage auf null, egal bei welchem Gewicht. Diese Funktion wird benutzt um z.B. das leere Flaschen-Gewicht abzuziehen.

Net

Beim Tarieren der Waage mit einem Gewicht auf der Plattform wird am Display «Net» angezeigt.



Durch das Erhöhen der Anzahl befüllten / entleerten Flaschen wo man verwendet hat, mittels der Hold Funktion, erhöht sich auch die Net Anzeige. Dies ist bis Net 9 möglich. Danach beginnt es wieder mit Net 1.

ZERO

Zurücksetzen der Waage auf null, bei einer Abweichung des Null-Stands der Gewichts-Anzeige von max. 125 gramm. Diese Funktion wird benutzt, wenn beim Einschalten der Waage eine kleine Abweichung angezeigt wird.

Haltefunktion

Eine spezielle Funktion auf der REFSCALE-S erlaubt es dir, den Wert einzufrieren. Diese Funktion kann z.B. beim Füllen oder Entleeren des Systems verwendet werden, wenn die Gasflasche leer oder voll ist.







Durch ein kurzes Drücken von  wird die Funktion aktiviert und auf dem Display erscheint das Symbol .

Um die Funktion zu deaktivieren, drücke erneut .

Alarm

Mit der REFSCALE-S kann ein programmierbarer Alarmwert eingestellt werden. Der Alarm ertönt, wenn der gewünschte Wert (entweder positiv für zunehmendes Gewicht oder negativ für abnehmendes Gewicht) erreicht wird.

Nach 90 % des programmierten Wertes ertönt ein Annäherungsalarm. Mit einem alternierenden Ton wird darauf aufmerksam gemacht, dass der eingestellte Wert fast erreicht ist. Beim Erreichen von 100 % ertönt ein andauernder Ton.

1.  lang drücken, ins Menü eintreten
2.  drücken, zu Alarm navigieren
3.  drücken, bestätigen
4.  drücken, «SET» wird angezeigt
5.  drücken, «SET» bestätigen
6.  drücken, Wert festlegen, bei welchem Alarm ausgelöst werden soll
7.  drücken, Wert bestätigen



Der Alarmwert kann nur als positiver Wert eingegeben werden, aber er zählt sowohl in positiver als auch in negativer Richtung.









Bei einer Änderung der Einheit, muss der programmierte Wert neu gesetzt werden.

Um einen programmierten Alarm zu aktivieren oder deaktivieren, halte  3 Sekunden lang gedrückt.









Alarm Ton deaktivieren / aktivieren

Im Alarm Modus kann der akustische Ton deaktiviert werden und es wird nur eine optische Anzeige auf das Display ausgelöst.

1.  lang drücken, ins Menü eintreten
2.  drücken, zu Alarm navigieren
3.  drücken, bestätigen
4.  drücken, zu  (Ton deaktiviert) navigieren
5.  drücken, «Ton deaktiviert» bestätigen







Auf das Display erscheint folgendes Symbol, wenn der Alarm ausgelöst wird: 

Um den akustischen Alarm / Ton wieder zu aktivieren:

1.  lang drücken, ins Menü eintreten
2.  drücken, zu Alarm navigieren
3.  drücken, bestätigen
4.  drücken, zu  ;  ;  (Ton aktiviert) navigieren
5.  drücken, «Ton aktiviert» bestätigen

Tank-Kapazität

Es ist oft praktisch, die relative Menge des in einer Gasflasche (Tank) verbleibenden Gases zu kennen. Der REFSCALE-Tankkapazitätsmodus ermöglicht eine kontinuierliche Anzeige des prozentualen Anteils des in einem Tank verbleibenden Gases. Um den Prozentsatz genau berechnen zu können, muss die REFSCALE-S mit den Gewichten eines leeren und eines vollen Tanks trainiert werden. Führe folgende Schritte durch, um den Tank-Kapazitätsmodus der REFSCALE-S zu trainieren:

1.  lang drücken, ins Menü eintreten
2.  drücken, zu Tank-Kapazität navigieren
3.  drücken, bestätigen
4.  drücken, zu «SET» navigieren
5.  drücken, bestätigen
6. Auf dem Display wird 0% angezeigt, womit angezeigt wird, dass das Gewicht eines leeren Behälters registriert werden muss.
Stelle eine leere Gasflasche (oder eine Last, die dem Gewicht einer leeren Gasflasche entspricht) auf die Plattform. Warte 5 Sekunden, bis sich die Last stabilisiert hat.
7.  drücken, bestätigen
8. Auf dem Display wird 100% angezeigt, womit angezeigt wird, dass das Gewicht einer vollen Flasche registriert werden muss.
Stelle eine volle Gasflasche (oder eine Last, die dem Gewicht einer vollen Gasflasche entspricht) auf die Plattform. Warte 5 Sekunden, bis sich die Last stabilisiert hat.
9.  drücken, bestätigen

10. Damit ist der Trainingsprozess abgeschlossen und die Anzeige 100% erlischt.

Tank-Kapazität Anzeige

Nach 90 % des programmierten Wertes ertönt ein Annäherungsalarm mit einem alternierenden Ton. Auf dem Display erscheint folgendes Symbol, bei dem der oberste horizontale Balken zu blinken beginnt: 

Beim Erreichen von 100 % ertönt ein andauernder Ton und das Symbol blinkt nicht mehr.







Zwischen 10% und 90 wird folgendes Symbol angezeigt: 

Beim Annähern von 10% ertönt ein Annäherungsalarm mit einem alternierenden Ton. Auf dem Display erscheint folgendes Symbol, bei dem der unterste horizontale Balken zu blinken beginnt: 









Beim Erreichen von 0 % ist am Symbol der unterste horizontale Balken nicht mehr sichtbar.

Tank-Kapazität Ton deaktivieren / aktivieren





Im Tank-Kapazität Modus kann der akustische Ton deaktiviert werden und es wird nur die optische Anzeige auf das Display ausgelöst.

1.  lang drücken, ins Menü eintreten
2.  drücken, zu Tank-Kapazität navigieren
3.  drücken, bestätigen
4.  drücken, zu  (Ton deaktiviert) navigieren
5.  drücken, «Ton deaktiviert» bestätigen

Um den akustischen Alarm / Ton wieder zu aktivieren:





6.  lang drücken, ins Menü eintreten
7.  drücken, zu Tank-Kapazität navigieren
8.  drücken, bestätigen
9.  drücken, zu  ;  ;  (Ton aktiviert) navigieren
10.  drücken, «Ton aktiviert» bestätigen

Tank-Kapazität einschalten





1.  lang drücken, ins Menü eintreten
2.  drücken, zu Tank-Kapazität navigieren
3.  drücken, bestätigen
4.  drücken, zu «On» navigieren
5.  drücken, bestätigen

Von diesem Zeitpunkt an zeigt die numerische Anzeige den Prozentsatz des in der Gasflasche verbleibenden Materials von 0 % bis 100 % an.

Tank-Kapazität ausschalten

1.  lang drücken, ins Menü eintreten
2.  drücken, zu Tank-Kapazität navigieren
3.  drücken, bestätigen
4.  drücken, zu «OFF» navigieren
5.  drücken, bestätigen





Funkkonfiguration

1.  lang drücken, ins Menü eintreten
2.  drücken, zu Funkkonfiguration navigieren
3.  drücken, bestätigen
4.  drücken, um «On / OFF» anzuwählen
5.  drücken, um Auswahl zu bestätigen

Um eine Verbindung herzustellen, muss das Symbol für die Funkverbindung blinken, was anzeigt, dass die Waage nach einer Verbindung sucht. Sobald eine Verbindung zu einem Gerät hergestellt ist, leuchtet das Symbol kontinuierlich.

Die Verbindung mit der Waage erfolgt über der REFIMATE oder REFIMESH. Während die Verbindung zu einem externen Ventil (Ventilansteuerung) über die Waage stattfindet. Ist die Funkkonfiguration aus, so sind eingehende und ausgehende Verbindung nicht möglich.



Einheiten (kg / lb / oz / lb&oz)

1.  lang drücken, ins Menü eintreten
2.  drücken, zu Masseinheit navigieren
3.  drücken, bestätigen
4.  drücken, um zwischen den Einheiten zu wählen
5.  drücken, um Einheit zu bestätigen

Kalibrierung = CalO

Die REFSCALE-S wird im Werk kalibriert, um eine hohe Genauigkeit zu gewährleisten. Obwohl eine Rekalibrierung nur selten, wenn überhaupt, notwendig sein sollte, ist eine Feld-Kalibrierung einfach durchzuführen, ohne das Produkt zur Wartung an den Hersteller zu schicken. Zur Feld-Kalibrierung der Waage ist ein bekanntes Kalibriergewicht (in Kilogramm) erforderlich, das zwischen 10 kg und 100 kg liegen kann. Die höchste Genauigkeit wird durch die Verwendung des größten verfügbaren Gewichts erreicht.





Die Feld-Kalibrierung muss mit genormten Gewichten durchgeführt werden. Die REFSCALE-S muss auf eine feste, ebene Oberfläche platziert werden.

1. Entferne alle Gegenstände von der Plattform.
2.  lang drücken, ins Menü eintreten
3.  drücken, zu Kalibrierung navigieren
4.  drücken, bestätigen
5.  drücken, zu «CalO» navigieren
6.  drücken, bestätigen
7. Kalibriergewicht angeben mittels , z.B. 20Kg
8.  drücken, «Set 0kg» wird angezeigt
9.  drücken, z.B. 20.000 Kg wird angezeigt
10. Gewicht von 20Kg drauflegen. Warte 5 Sekunden, bis sich die Last stabilisiert hat.
11.  drücken, bestätigen
12. Anzeige auf Display «SAVED»

Wiederherstellung der Werkskalibrierung = Call





Wenn du bei der Feld-Kalibrierung der REFSCALE-S einen Fehler machst, kann jederzeit die Werkskalibrierung der Waage wiederhergestellt werden.

Führe zum Wiederherstellen der Werkseinstellung folgende Schritte aus:

1.  lang drücken, ins Menü eintreten
2.  drücken, zu Kalibrierung navigieren
3.  drücken, bestätigen
4.  drücken, zu «Call» navigieren
5.  drücken, bestätigen





Gravitation / GEO

Je nach Erdregion wo die REFSCALE-S verwendet wird, herrscht eine andere Gravitation vor. Deshalb können unterschiedliche Gravitations-Werte angewählt werden.

-  lang drücken, ins Menü eintreten
-  drücken, zu Gravitation navigieren
-  drücken, bestätigen
-  drücken, zur gewünschten Gravitations-Nummer / GEOx gemäss nachstehende Tabelle navigieren
-  drücken, bestätigen

Gravitations-Nummer	Wert	Stadt
GEO1	GEO1 = 9,80669 m/s ²	Zürich
GEO2	GEO2 = 9,81268 m/s ²	Berlin
GEO3	GEO3 = 9,80988 m/s ²	Paris
GEO4	GEO4 = 9,81835 m/s ²	Stockholm
GEO5	GEO5 = 9,81249 m/s ²	Warschau
GEO6	GEO6 = 9,81190 m/s ²	London
GEO7	GEO7 = 9,80061 m/s ²	Washington
GEO8	GEO8 = 9,78741 m/s ²	Hong Kong
GEO9	GEO9 = 9,79652 m/s ²	Sydney

Ventilansteuerung (Automatisches Ventil in Entwicklung)

1.  lang drücken, ins Menü eintreten
2.  drücken, zu Ventilansteuerung navigieren
3.  drücken, bestätigen
4.  drücken, um zu On / Off oder SCAN zu navigieren
5.  drücken, um gewünschte Funktion zu bestätigen

On / Off: Ein- / Ausschalten der Verbindung zum Ventil.
Die Waage versucht sich automatisch mit einem REFCO Ventil zu verbinden.

SCAN: Suche und Verbindung zum REFCO Ventil über Bluetooth.







Wenn die Ventilansteuerung aktiviert ist, blinkt das Symbol «Ventil Verbunden»  am Display. Es versucht sich nun mit dem Ventil zu verbinden. Wenn es nicht mehr blinkt, ist das Ventil verbunden.

Wenn das Ventil offen ist, wird die Ventil Funktion mit Pfeil angezeigt .





Wenn das Ventil zu ist, wird die Ventil Funktion mit Unterbruch angezeigt .

Speichermodus

Im Arbeitsbetrieb werden durch Drücken der Enter Taste  die aktuellen Daten gespeichert. Maximal können 10 Daten gespeichert werden. Die Daten können aus dem Speichermodus nachträglich gelesen werden.

1.  lang drücken, ins Menü eintreten
2.  drücken, zum Speichermodus navigieren
3.  drücken, bestätigen
4.  drücken, um durch die Daten zu navigieren
5.  drücken, um die gewünschten Daten zu öffnen
6.  lang drücken, um den Speichermodus zu verlassen

Information

1.  lang drücken, ins Menü eintreten
2.  drücken, zu Information navigieren.
3.  drücken, bestätigen
4.  drücken, um zwischen den Informationen zu wechseln

SW V: Aktuelle Software Version

HW V: Aktuelle Hardware Version

PAR. C: Parameter Change Counter. Bei einer neuen Kalibrierung oder ändern vom GEO-Wert, erhöht sich die Anzeige.

6.2 Verbindungen

Mit der REFSCALE-S ist es möglich, eine Verbindung zur REFSCO REF MESH App oder zur digitalen Monteurhilfe REF MATE herzustellen. Um eine Verbindung zu REF MESH oder zu REF MATE herzustellen, muss das Symbol für die Funkverbindung blinken, was anzeigt, dass die Waage nach einer Verbindung sucht. Sobald eine Verbindung hergestellt ist, leuchtet das Symbol kontinuierlich.

Verbindung zum REF MESH

Über die REF MESH App kann einfach eine Verbindung zur REFSCALE-S hergestellt werden. Im App-Fenster unter "Verbinde" erscheint die REFSCALE-S und kann verbunden werden. Über REF MESH ist es möglich, Tara zu setzen, die Haltefunktion zu verwenden, einen Alarm zu setzen und einen Wert zu speichern, der in einem Bericht angezeigt werden kann.

Verbindung zum REF MATE

Wenn das Verbindungssymbol blinkt, können Sie mit dem REF MATE einfach nach einem Gerät suchen. Befindet sich die REFSCALE-S innerhalb der Reichweite, verbindet sich das Gerät automatisch. Es ist nur möglich sich mit einer REFSCALE-S gleichzeitig zu verbinden. Auf dem REF MATE haben Sie Zugang zum zusätzlichen Bildschirm, indem Sie die WECHSEL (SWITCH) Taste drücken.

Empfehlung

Eine Verbindung von REF MESH und REF MATE gleichzeitig auf REFSCALE-S ist nicht möglich. Verbinden Sie dafür die REF MATE mit der REFSCALE-S und REF MESH mit der REF MATE. So wird in allen Geräten der aktuelle Messwert angezeigt.

7.0 Batterie-Management

Um die Batterielaufzeit zu erhöhen, hat die REFSCALE-S zwei Funktionen:

Automatische Abschaltung:

Nach 30 Minuten ohne Tastenbetätigung und ohne Änderung des Messwertes, schaltet sich das Gerät ab. Dies erfolgt nur sofern Energieversorgung mittels eingesetzter Batterie gewählt.

Alternative Stromquelle:

Anstatt Batterien zu verwenden, ist es möglich, die REFSCALE-S über USB Micro Typ B mit Strom zu versorgen, z. B. mit Hilfe eines Netzteils oder einer Powerbank.

8.0 Stabiler Messwert



Wird angezeigt wenn der Messwert stabil ist und es keine Veränderung erfährt.

Nur in diesem Zustand kann die Waage kalibriert und die Zero Funktion verwendet werden.

Wenn dies nicht erfüllt ist, muss die Waage neu ausgerichtet oder gestartet werden. Die REFSCALE-S muss auf eine feste, ebene Oberfläche platziert werden und sie darf keine Erschütterung erfahren.

9.0 Error / Fehler



Dies wird angezeigt, wenn etwas nicht OK ist.

Folgende Fehler können die Ursache sein:

- Fehlende Kalibration
- Zero geht nicht: Überschreitung der maximal, zugelassene Abweichungs-Grenze von 125gramm
- Waage ist nicht eben oder stabil platziert

9.1 Überlast-Anzeige

Wenn das auf die Plattform aufgebraachte Gewicht die maximale Kapazität der REFSCALE-S (110 kg / 243 lb) überschreitet, zeigt das Display "OOR" an, was "Out of Range" bedeutet. Dies gilt für die absolute Gewichtsmessung.



Um Schäden an der REFSCALE-S zu vermeiden, entferne das Gewicht sofort von der Plattform,

9.2 Troubleshooting-Guide

Fehler	Problem / Lösung
Gerät kann nicht eingeschaltet werden	Batterie falsch oder verkehrt eingelegt. Batterie Kontaktunterbruch wurde nicht herausgezogen.
OOR	Gewicht über 110 Kg. Gewicht sofort reduzieren.
Stabiler Messwert ist nicht erfüllt	Gerät neu ausrichten. Gerät neu starten.
Display Anzeige verändert sich nicht	Haltefunktion ist aktiv (Symbol Haltefunktion wird angezeigt).
Bluetooth Verbindung geht nicht	Es ist bereits ein Gerät verbunden. Dies ist erkennbar, wenn das Symbol Funkkonfiguration kontinuierlich leuchtet.
ZERO geht nicht	Überschreitung der maximal zugelassenen Abweichungs-Grenze von 125 g Gerät kalibrieren.

10.0 Garantie

Deine neue REFSCALE-S ist nach den neuesten arbeitsphysiologischen und ergonomischen Gesichtspunkten entwickelt worden und entspricht dem aktuellen Stand der Technik. Das Unternehmen REFCO Manufacturing Ltd wurde nach DIN EN ISO 9001:2015 zertifiziert. Regelmässige Qualitätskontrollen sowie eine sorgfältige Verarbeitung gewährleisten eine solide Funktionsfähigkeit und ermöglichen die REFCO-Garantie entsprechend den am Tag der Auslieferung geltenden allgemeinen Verkaufs- und Lieferbedingungen. Ausgenommen davon sind durch offensichtlich unsorgfältige Behandlung sowie durch Verschleiss entstehende Schäden.

11.0 Rücksendung und Entsorgung

Die REFSCALE-S ist für den Langzeitgebrauch entwickelt worden. Bei der Materialbeschaffung und der Produktion wurde auf Energieersparnis und Umweltverträglichkeit geachtet. REFCO Manufacturing Ltd sieht sich „zeitlebens“ verantwortlich für seine Produkte. Aus diesem Grund hat sich REFCO Manufacturing nach DIN EN ISO 14001:2015 zertifizieren lassen. Bei Ausserbetriebsetzung des Gerätes sollte der Anwender die geltenden Entsorgungsvorschriften seines Landes beachten. Das Gehäuse ist aus Thermoplast, Aluminium und Gummi hergestellt.



12.0 Ersatzteile und Zubehör

Ersatzteil	Artikel-Nr.	Bezeichnung
Batterie-Deckel	4688813	REFSCALE-BATTERY-COVER
Verpackung	4688963	REFSCALE-S-CASE
Zubehör	Artikel-Nr.	Bezeichnung
Befüll-Adapter für Kältemittel- dosen	4688637	10612-REF-ACME-LH (1/2"-16G)
	4682773	10612-REF-1/4"SAE
	4677027	10612-REF
Ständervorrich- tung für Kältemittel- dosen	4688316	10612-50-ACME-LH
	4682781	10612-50-1/4"SAE
	9885074	10612-50



REFCO Manufacturing Ltd.

Industriestrasse 11
CH-6285 Hitzkirch
+41 41 919 72 82
info@refco.ch
www.refco.ch